



UW GIDS NAAR VEILIGHEID  
VOTRE GUIDE VERS LA SECURITE

**PIKT-O-NORM<sup>®</sup>**

# PIKT-O-NORM®

Een compleet gamma signalisatie & pictogrammen - volgens Europese normen  
Une gamme complète de signalisation & pictogrammes - suivant normes européennes

ALLE AFMETINGEN IN DEZE CATALOGUS ZIJN IN MILLIMETER TENZIJ ANDERS VERMELD  
TOUTES LES DIMENSIONS DANS CE CATALOGUE SONT EN MILLIMÈTRES, SAUF INDICATION CONTRAIRE

## MATERIALEN

## MATERIAUX

### Afkortingen

### Abréviations

Vin.	= Vinyl zelfklevende sticker (permanent of non-permanent) Vinyl autocollant (permanent ou non-permanent)
Greenline	= Chloorvrije zelfklevende sticker met UV bescherming Autocollant sans chlorides avec protection UV
Ultr.Destr.	= Ultra destructible - fragmenteerbare zelfklever Ultra destructible - autocollant fragmentable
Supert.	= Supertack - zelfklever met extra sterke kleeftlaag Supertack - autocollant avec couche adhésive plus forte
Vin.Refl.	= Reflecterende zelfklevende sticker Autocollant réfléchissant
PP (0,8 - 1,5mm)	= Polypropyleen plaat Plaque polypropylène
PVC (0,3 - 1 - 1,5 - 2mm)	= PVC plaat Plaque PVC
Forex (3 - 5 - 8mm)	= Harde schuimplaat Plaque mousse rigide
Alu.Anod.Plat (1,5mm)	= Geanodiseerd aluminium Aluminium anodisé
Alu.Anod.Prof.	= Geanodiseerd aluminium met zwarte kunststof eindkappen Aluminium anodisé profilé avec finition synthétique noire
Signicolor (1 - 1,5mm)	= Gelakt aluminium Aluminium laqué
Dibond (2 - 3 - 4mm)	= Harde plaat met aluminium boven- en onderlaag en kunststof kern Plaque rigide constituée de 2 tôles alu et d'un noyau synthétique
KI. 1 / Cl. 3	= Retroreflecterend / retroréfléchissant
KI. 2 / Cl. 3	= High Intensity (retroreflecterend / retroréfléchissant II)
KI. 3 / Cl. 3	= Diamond Grade (retroreflecterend / retroréfléchissant III)

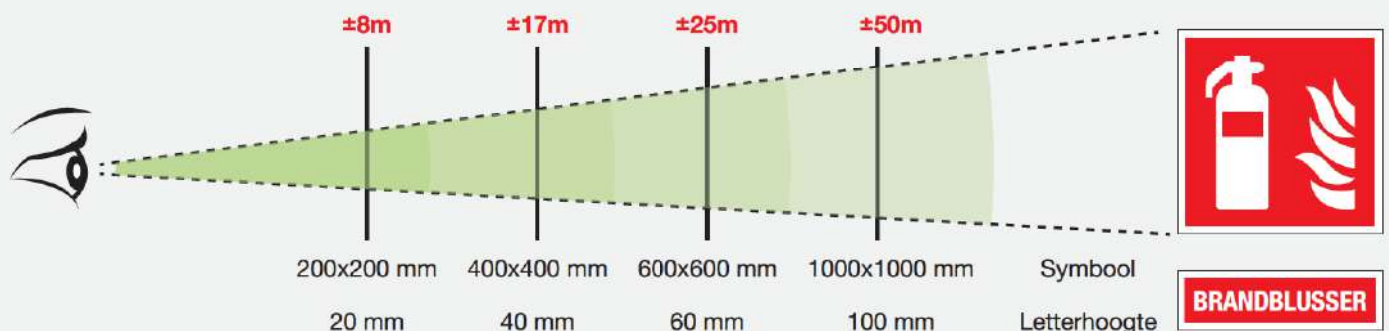

Alle codes, omschrijvingen, foto's, gegevens en producten in deze catalogus zijn onder voorbehoud.  
Contacteer ons voor de meest recente informatie

Tous les codes, descriptions, photos, données et produits dans ce catalogue sont sous réserve.  
Contactez-nous pour les informations les plus actuelles.



ISO 7010

PVC 0,3mm  
650x930mm 992915

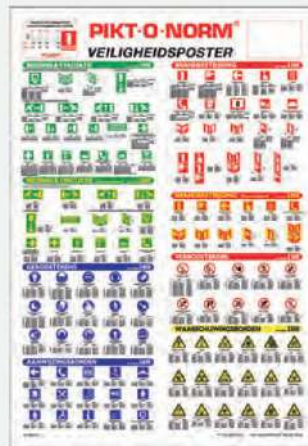

Veiligheid

PVC 0,3mm  
992910NL



Sécurité

PVC 0,3mm  
992911FR



ADR

PVC 0,3mm  
992912



CLP / GHS

PVC 0,3mm  
650x930mm 992913NL



CLP / SGH

PVC 0,3mm  
992914FR



Verkeer / Routière

PVC 0,3mm  
992916



Posters met uw eigen teksten, picto's, logo's...op het door u gewenste formaat, op aanvraag.  
Posters avec votre propres textes, picto's, logo's...avec vos dimensions, sur demande.

## NOG OP ZOEK NAAR EEN IDEAAAL GEPERSONALISEERD PROMOTIEMIDDEL? A LA RECHERCHE D'UN MOYEN PERSONNALISE IDEAL DE PROMOTION?



PP 1,5mm



PVC 1mm



Photolum PVC 1mm



GHS / SGH



Adreskaartje  
Carte de visite

CONTACTEER UW VOORTVERKOPER

CONTACTEZ VOTRE REVENDEUR

Materialen - Matériaux	2
Afkortingen - Abréviations	2
Posters - Posters	3
Inhoudstafel - Table des matières	4-11
<hr/>	
Redding & evacuatie ISO 7010 - Evacuation & Sauvetage ISO 7010	12-22
AED ISO 7010 - DEA ISO 7010	22
Defibrillatoren - Défibrillateurs	22
Redding & evacuatie - Evacuation & Sauvetage	23-36
Verzamelplaats - Point de rassemblement	23
Palen & Toebehoren - Poteaux & Accessoires	23
België K.B. 21-04-2007 - Belgique A.R. 21-04-2007	34
Ilicor - Ilicor	35
Helmstickers - Étiquettes pour casque	35
Niveau aanduiding - Indication niveau	36
Routemarkering - Marquage de route	37
Voetafdrukken - Handafdrukken - Empreintes pieds - Empreintes mains	37
Fotolum kleefbanden - Rubans adhésifs photolum	37
Fotolum punten - Pijlen - Flèches - Points photolum	37
Vluchtwegsignalering	38
Fotolum - Photolum	38
Noodverlichting - Eclairage de secours	39-42
Led - Led	39-40
TL - TL	41
Pictogrammen noodverlichting - Pictogrammes éclairage de secours	41
Verplaatsbare noodlampen - Lampes de secours transportables	42
Vergrendeling nooduitgang - Verrouillage des issues de secours	43
Exit control - Exit control	43
Deur alarm - Alarm porte	43
<hr/>	
Brandbestrijding ISO 7010 - Protection incendie ISO 7010	44-50
Combipictogrammen - Pictogrammes combinés	48-50
Brandbestrijding classificatie - Protection incendie classification	51
Brandbestrijding - Protection incendie	51-59
Combipictogrammen - Pictogrammes combinés	57-59
Brandbestrijding - Teksten - Protection incendie - Textes	60
Locatieaanduiding - Hydrant - Emplacement Technique - Bouche d'incendie	61
Palen & Toebehoren - Poteaux & Accessoires	61
Locatieaanduiding - Emplacement Technique	62
Richtlijnen bij brand - Directives en cas d'incendie	63
Keuringsstickers - Pastilles calendrier	64-65
Andere modellen op aanvraag - Autres modèles sur demande	65
<hr/>	
Safety sign services - Safety sign services	66
Evacuatieplannen - Plans d'évacuation	
IOS software - IOS software	67
Minipicto ISO 7010 - mini picto ISO 7010	67
Mini picto - Mini picto	68
Redding & evacuatie - Signalisation d'évacuation	68
Brandbestrijding - Protection incendie	68-69
Verbod - Interdiction	69
Gebod - Obligation	70

# INHOUD CATALOGUS

# CONTENU CATALOGUE

Waarschuwing - Avertissement	70
Aanduiding - Indication	70
Diversen - Divers	70
IMO - IMO	71
Verkeer - Circulation	71-72
<hr/>	
Brandbestrijdingsmiddelen - Matériaux anti-feu	73
Windsnelheid - Girouettes	74
Ongevallenborden - Ecrans d'accidents	75
<hr/>	
Reddingsmiddelen - Equipment sauvetage	76
Manuele alarmsystemen - Système d'alarme manuels	76
Reddingsvesten - Gilets de sauvetage	76
Reddingsboeien - Bouées de sauvetage	76
Vloerstickers - Marquages au sol	77
IMO SIGNS - Fotoluminiscerend - IMO SIGNS - Photoluminescent	78-87
Mini picto IMO - IMO (MINI PICTO)	87
Snaplight - Signaleer uzelf - Snaplight - Signalez-vous	87
Scheepvaart & Offshore Markering buisleidingen op rol - Maritimes & Offshore Marquage de tuyauteries sur rouleau	88-89
<hr/>	
Verbodstekens ISO 7010 - Signaux d'interdiction ISO 7010	90-92
Verbodstekens - Signaux d'interdiction	93-98
Verbodstekens - Teksten - Signaux d'interdiction - Textes	99-101
Parkeerverbod - Interdiction de stationner	101
Richting voor deuren - Direction pour portes	101
<hr/>	
Gebodstekens ISO 7010 - Signaux d'obligation ISO 7010	102-105
Gebodstekens - Signaux d'obligation	106-108
Gebodstekens - Teksten - Signaux d'obligation - Textes	109-110
Secubox - Secubox	111
Secubox - Secupoint - Secubox - Secupoint	112
Personaliseer uw secubox/secupoint - Personnalisez votre secubox/secupoint	
Secubox - Dispenser - Secubox - Distributeur	112
Secucase - Secucase	112
Secupoint - Secupoint	112
Eerste hulp - Premiers secours	113
Pleisterdispenser - Distributeurs pansements	113
Brandwondenverzorging - Soins brûlures	114
Vital-ID - Vital-ID	114
Interventie signalisatie - Signalisation d'intervention	115
<hr/>	
Gevaarstekens ISO 7010 - Signaux de danger ISO 7010	116-119
Gevaarstekens - Signaux de danger	120-123
Gevaarstekens - Teksten - Signaux de danger - Textes	124
Eerste hulp bij elektrocutie - Premiers soins en cas d'électrocution	125
Machine richtlijnen - Directives machines	125-127
<hr/>	
Aanwijzingsborden - Signaux d'indication	130-140
Gegraveerde en gefreesde borden - Panneaux gravés et découpés	141
Industriële markering - Marquage industriel	141
Gegraveerde merkplaatjes - Plaques marquages gravées	141

## INHOUD CATALOGUS

## CONTENU CATALOGUE

Gepersonaliseerde eigendomsetiketten - Etiquettes propriété personnalisées	141
Gefreesde pictogrammen - Pictogrammes découpés	142-143
Camerabewaking - Surveillance par caméra	144
Camerabewaking - Wet van 21-03-07 - Surveillance par caméra - Loi du 21-03-07	144
Recyclage - Recyclage	145
<hr/>	
Blanco materialen - Matériaux blanco	146
Spiegelbeeld - Image réfléchie	147
Vogels op transfert - Oiseaux sur transfert	147
<hr/>	
Begeleiding - Guidance	148-157
<hr/>	
Tekens op transfert - Signaux sur transfert	158-165
<hr/>	
Infoplaatjes ALU LOOK - ALU LOOK plaquettes d'information	166-167
Ophangpictogrammen - Pictogrammes à crochet	168-171
Teksten - Textes	172-177
<hr/>	
MT-met uw eigen tekst - MT-avec votre propre texte	178
Bevestigingen - Fixations	179-186
Badges - Badges	187-188
Badgehouder - Porte badge	187
Halskoord voor badgehouder - Cordons pour porte-badge	187
Krokodilclip - Pince crocodile	188
Oprolsystemen voor badgedragers - Enrouleurs pour support de badge	188
Plexi-line	189-190
Plexiholder - Porte-Affiche Plexi	193
ALU-line	191-195
Curvo	191
Plato plus	192
Module plus indoor	193-194
Pyxis	195
Module plus outdoor	196
Outdoor signage - Outdoor signage	197-198
Vitrines - Vitrines	199-203
Binnen - Intérieur	199-200
Buiten - Extérieur	201-203
Posterframes - Posterframes	203
Binnen - Intérieur	203
Clicframes - Clicframes	204-205
Indoor - Indoor	204-205
Outdoor - Outdoor	205
Stoepborden - Stop-trottoir	205
Mededelingsborden - Tableaux d'affichage	206-208
Magneetborden - Tableaux magnétiques	206-207
Kurborden - Tableaux en liège	208
Brochure- en taghouders - Porte brochures et tags	208-209
Tafelmodel - Modèle table	208
Muurmodel - Modèle murale	209
Tafel- en muurmodel - Modèle table et murale	209
Buitengebruik - Usage extérieur	209
Transway - Transway	210-212
Palen met afrolbare linten - Poteaux à sangles	210-212

## INHOUD CATALOGUS

Palen met dubbele afrolbare linten - Poteaux à sangles doubles	212
Afrolbare linten - Sangles	212
Afbakening - Délimitation	213-225
Afrolbare XXL linten - Sangles XXL	213
Kegeladapters met afrolbare linten - Dérouleurs de sangle pour cônes	214
Infopalen - Poteaux info	214-215
Palen voor koorden of kettingen - Poteaux pour cordons ou chaînes	216
Metalen palen voor koorden of kettingen - Poteaux métalliques pour cordons ou chaînes	217
Palen voor kettingen - Poteaux pour chaînes	217
Palen - Poteaux	218-219
Kegeladapters voor ketting - Adaptateurs cônes pour chaînes	220
Kettingen - Chaînes	220
Telescopische barrières - Barrières télescopiques	221
PVC-planken voor kegeladapters - Planches PVC pour adaptateurs cône	221
Bakens - Balises	221-222
Parkeerbeugels - Barrières de parking	226
Parkingsignalisatie - Signalisation parking	227-230
Palen & Toebehoren - Poteaux & Accessoires	228
Palen & Toebehoren - Poteaux & Accessoires	231-232
Palen - Poteaux	231
Voeten - Pieds	231
Beugels - Brides	232
Borden - Panneaux	233-234
Borden pijlvorm - Panneaux en flèche	234
Wegsignalisatie - Signalisation Routière	235-238
Gevaarsborden - Panneaux de danger	235
Voorrangsborden - Panneaux relatifs à la priorité	235
Verbodsborden - Panneaux d'interdiction	235
Gebodsborden - Panneaux d'obligation	236
Stilstaan en parkeren - Panneaux relatifs à l'arrêt et au stationnement	236
Zoneborden - Panneaux à validité zonale	236
Onderborden - Panneaux additionnels	236
Aanwijzingsborden - Panneaux d'indication	237
Mini picto verkeer - Mini picto circulation	238
Gevaar - Danger	238
Voorrang - Priorité	238
Aanwijzing - Indication	238
Parkeren - Stationner	238
Verkeershulp - Aides circulation	239-240
Verkeersvertragers - Ralentisseurs	239
Toegangshellingen - Rampes d'accès	240
Stoatkussen - Coussin butoir	240
Afbakeningsbordjes - Plots de chaussée	240
Kabel- & slangbescherming - Protection cables & tuyaux	241
Binnengebruik - Rubber - Usage intérieur - caoutchouc	241
Met gele waarschuwingsstrip - Avec bande jaune d'avertissement	241
Industrieel binnen- en buitengebruik - Utilisation industrielle intérieure et extérieure	242
Verkeersdrempel met gele waarschuwingsstrip - Ralentisseur avec bande jaune d'avertissement	242
Kabelbescherming - Protection cables	
Stootbanden - Amortisseurs de choc	243-245
Met RVS-muurplaten - Avec plaques murales inox	245
Stoelhoeken - Coins amortisseurs	245
Kolombescherming - Protection colonne	246
Industriële bescherming - Protection industrielle	247-251

## CONTENU CATALOGUE

## INHOUD CATALOGUS

Hoekbescherming - Protection coin	247
Veiligheidsreling - staal - Rampe de sécurité - acier	247
Veiligheidsreling - Rampe de sécurité	248
Veiligheidsreling voor machines - Rampe de sécurité pour machines	248
Veiligheidspaal - Poteau de sécurité	248
Verkeersbarrière - Barrière traffic	249
Veiligheidsbarrière - Barrière de sécurité	249
Beschermingsbarrières - Barrières protection	250-251

<b>Afsluiting - Verouillage</b>	<b>252-254</b>
Netten - Clôtures	252
Bareel - Barrière	252
Harmonicahekken - Barrières harmonica	253
Opvulbare hekken - Barrières à lester	253
Separatoren - Séparateurs	254
Zebraorden - Panneaux zèbres	254
<b>Opvouwbare signalisatie - Signalisation pliable</b>	<b>254-255</b>
Opvouwbare driehoeken - Triangles pliables	254
Gevarendriehoeken - Triangles danger	255
Plooibare bakens - Balises pliantes	255

<b>Werfborden - Panneaux chantiers</b>	<b>256</b>
--	------------

<b>Markering - Marquages</b>	<b>257-262</b>
Werfmarkeringen - Traceurs de chantier	257
Evenementmarkeringen - Marquage événementiel	257
Toebehoren - Accessoires	258
Multidirectionele spuitbus 360° - Traceur multidirectionnel 360°	258
Voorlopige afdekking - Marquage provisoire	258
Speciaal voor grasvelden - Spécialement pour gazons	258
Markering bosbeheer - Traceurs forestier	259
Vloermarkering - Marquage au sol	260-261
Toebehoren - Accessoires	261
Veiligheidsmarkeringen - Marquages sécurité	261
Viltstiften - Feutres	262
Krijt - Craies	262
<b>Sjablonen - Pochoirs</b>	<b>263-264</b>

<b>Magazijnsignalisatie - Signalisation Magasin</b>	<b>265-269</b>
Cijfers en letters op vel - Chiffres et lettres sur feuille	265
Tekststen op transfert - Textes sur transfert	266
Uitgekapte cijfers en letters - Chiffres et lettres découpées	266
Magnetische cijfers en letters - Chiffres et lettres magnétiques	266
Haakse pictogrammen - Pictogrammes en drapeau	267
3D-4D pictogrammen - Pictogrammes 3D-4D	267
Insteekhoezen - Pochettes	267
Barcodes - vloerlabels op maat - Codes-barres - labels de sol sur mesure	268
Cijfers en letters groot formaat - Chiffres et lettres grand format	268
Palletmarkeringen - Marquages palettes	269
Tijdelijke vloermarkeringen - Marquages temporaires	269
<b>Magneetlabels - Labels magnétiques</b>	<b>270-271</b>
Etiketten - Etiquettes	270
Rollen - Rouleaux	270
Rollen C-profiel - Rouleaux Profile-C	270
Metaalfolie - Film métallique	271

## CONTENU CATALOGUE

## INHOUD CATALOGUS

Magnetische symbolen - Symboles magnétiques	271
Papiervellen - Feuilles papier	271
Magnetische pictogrammen - Pictogrammes magnétiques	271
Veiligheidszegels - Scellés de sécurité	272-275
Kabelbinders - Serre-câble	272
Zegels - Scellés	272-275

<b>Tapes - Bandes</b>	<b>276-282</b>
Tapes & markeringsbanden - niet voor vloer - Tapes & bandes de marquages - non-sol	276
Retroreflecterende tapes - niet voor vloer - Tapes rétro réfléchissants - non-sol	276
Fotolum tapes - niet voor vloer - Tapes Photolum - non-sol	276
Vloermarkering - Marquage sol	276
PermaRoute - PermaStripe - PermaRoute-PermaStripe	277
Palletmarkeringen - Marquages palettes	278
Magazijnaanduidingen - Indications magasins	278
Antislip Tapes - Bandes antidérapantes	279
Antislip tegels / voeten - Dalles / Pieds antidérapantes	279-280
AquaSafe - Tapes - Bandes - AquaSafe	281
AquaSafe - Tegels / Voeten - Dalles / Pieds - AquaSafe	281
Soft grip - Soft grip	281
Cushion grip - Cushion grip	282
Material grip - Material grip	282
Safety grip - Safety grip	282
Aluminium bodemplaat - Plaque aluminium	282
<b>Linten - Rubans</b>	<b>283</b>
Afbakeningslinten - Rubans de balisage	283
Noodgevallinten - Rubans cas d'urgence	283
Gepersonaliseerd lint - Rubans personnalisés	283
Ondergronds waarschuwingslint - Rubans d'avertissement sous-terrain	283

<b>Spiegels - Miroirs</b>	<b>284-287</b>
Verkeersspiegels - Miroirs traffic	284
Industriële spiegels - Miroirs industriels	285
Achteruitkijkspiegels - Rétroviseurs	285
Bewakingsspiegels - Miroirs de surveillance	286
Palen & Toebehoren - Poteaux & Accessoires	286
Inspectiespiegels - Miroirs d'inspection	287
Winkelspiegels - Miroirs de magasin	287
<b>Peli Lampen - Lampes Peli</b>	<b>288-292</b>
<b>Peli Koffers - Coffres Peli</b>	<b>293</b>

<b>Signaleer uzelf - Signalez-vous</b>	<b>294</b>
--	------------

<b>TRAFF-O-SIGN</b>	<b>295-310</b>
Transport gevaarlijke stoffen IMDG-IATA - Transport produits dangereux IMDG-IATA	295
Transport gevaarlijke stoffen ADR-RID - Transport produits dangereux ADR-RID	296
Zelfklevers op rol - Autocollants sur rouleau	297
ADR panelen - Panneaux ADR	297-298
Borden zonder code - Panneaux sans code	298-299
Borden met code - Panneaux avec code	299-300
Plaathouders - Supports panneaux	300-301
Cijfers - Chiffres	301
Toebehoren - Accessoires	301
Borden zonder code - Panneaux sans code	302
Borden met code - Panneaux avec code	302

## CONTENU CATALOGUE

## INHOUD CATALOGUS

## CONTENU CATALOGUE

Plaathouders - Supports panneaux	302
Diverse transport - Transport divers	302-303
Achterzijde markering - Marquage arrière	304
Voertuigmarkering - Marquage pour voitures	304-305
Uitzonderlijk vervoer - Transport exceptionnel	306-308
Interventielampen - Lampes d'intervention	308
Zwaailichten - Feux-gyrophares	308-309
Reflectoren - Réflecteurs	309
Kegels - Cônes	309-310
Nummerplaten - Plaques d'immatriculation	310
<hr/>	
Transport-verpakking - Transport emballage	311-312
Verpakkingstapes - Tapes d'emballage	311-312
<hr/>	
CLP-Etikettering - Etiquetage CLP	313-317
Gevaarlijke stoffen - Produits dangereux	313-314
Zelfklevers op rol - Autocollants sur rouleau	315
Etikettendispensers - Distributeurs étiquettes	315
Etiketten met tekst - Etiquettes avec texte	316-317
Verpakkingstape - Tape d'emballage	317
<hr/>	
Leidingmarkeringen - Marquage de tuyauteries	318-333
Leidingmarkeringen op rol - Marquage de tuyauteries sur rouleau	334-335
Markering van blusleidingen - Marquage de tuyauteries incendie	335
Markering volgens DIN 2403 - Marquage suivant DIN 2403	335
Procesidentificatie - Identification proces	335-336
Bordhouders - Support panneaux	335
Toebehoren - Accessoires	336
<hr/>	
Masterlock veiligheidshangsloten - Masterlock cadenas de sécurité	337-342
Sleutelsystemen - Systemes de clés	337
Zenex sloten met stalen beugel - Cadenas Zenex avec anse en acier	338-339
Zenex sloten met Zenex beugel - Cadenas zenex avec anse en Zenex	339-340
Gravures - Gravages	340
Aluminium sloten - Cadenas en aluminium	341-342
Stalen sloten - Cadenas en acier	342
Masterlock vergrendelingssystemen - Masterlock systèmes de condamnation	343-355
Slotvermeerdereaars - Crochets multi-points	343-344
Toebehoren - Accessoires	344
Lock-out stations - Stations lock-out	345-346
Slotenrekken - Etagères à cadenas	346
Lock-out kits - Kits lock-out	347-348
Roterende kraanvergrendelaars - Condamnation de vannes réglables	349
Vergrendeling van schuifafsluiters onder druk - Consignation de vannes de gaz sous pression	349
Vergrendeling afsluiters - Consignation de vannes	350-351
Pneumatische vergrendeling - Condamnation pneumatique	351
Vergrendeling voor stroomonderbrekers - Bloques disjoncteur	353
Vergrendelingssystemen - Systèmes de condamnation	353
Beschermkappen - Capots de protection	354
Stuurovertrek - Condamnation volant	354
Sleutelbeheerkasten - Boîtes de condamnation	355
Masterlock Identificatie - Masterlock Identification	356
Hangslotlabels - Etiquettes d'identification de cadenas	356
Identificatie voor vergrendelingspunt - Identification pour lock-out	356
Masterlock Beveiliging - Masterlock Sécurité	357-358

## INHOUD CATALOGUS

Waarschuwingstags - Tags de danger	357-358
Masterlock Identificatie - Masterlock Identification	359
Waarschuwingstags -Tags de danger	359
Gepersonaliseerde tags - Tags personnalisés	359
Lock-out tags - Tags lock-out	359
Tags - Tags	360-367
Waarschuwingstags - Etiquettes de prévention	360-364
Toebehoren - Accessoires	361
Afscheurbare labels - Etiquettes arrachables	365
Afscheurbare gasfleslabels - Etiquettes arrachables pour cylindres	365
Inspectietags - Etiquettes d'inspection	365
Zelfklevende labels - Etiquettes adhésives	366
Identificatielabels - Tags d'identification	366
Blanco labels - Etiquettes blanco	366-367
Toebehoren - Accessoires	367
Masterlock beveiliging - Masterlock sécurité	368-380
Slotsmeerstift - Lubrifiant pour systèmes de fermeture	368
Bluetooth gestuurd hangslot - Cadenas connectés bluetooth	369
Stalen hangsloten - Cadenas en acier trempé	369
Massiefstalen hangsloten - Cadenas en acier massif	369
Roestvrijstalen hangsloten - Cadenas en acier inoxydable	370
Messing hangsloten - Cadenas en laiton	370
Massiefstalen hangsloten - Cadenas en acier massif	370
Gelamineerde stalen hangsloten - Cadenas en acier laminé	371
Messing hangsloten - Cadenas en laiton	371
Cijferhangsloten - Cadenas à combinaison	371
Gelamineerde stalen hangsloten - Cadenas en acier laminé	372
Excell hangsloten - Cadenas excell	372
Rechthoekige hangsloten - Cadenas rectangulaires	373
Messing hangsloten - Cadenas en laiton	373
Hangsloten voor buitengebruik - Cadenas extérieur	373
Programmeerbare cijferhangsloten - Cadenas à combinaison programmable	374
Messing hangsloten - Cadenas en laiton	374
Hangsloten voor buitengebruik - Cadenas extérieur	375
Programmeerbare cijferhangsloten - Cadenas à combinaison programmable	375
Noodhangslot - Cadenas d'urgence	376
Draagbare hangsloten - Cadenas portatifs	376
Heavy duty grendels - Morillons haute sécurité	376-377
Hangslotogen - œillets pour cadenas	377
Scharnierende grendels - Morraillons à charnière	377
Heavy duty grendels - Morillons haute sécurité	378
Python verstelbare vergrendelingskabel - Câble de verrouillage réglable Python	378
Kabel met lussen en kettingen - Câbles à boucles et chaînes	379
Sleutelkoffers - Boîtes à clés	379
Sleutelkasten - Armoires à clés	380
Anti-diefstal slot voor garagepoort - Antivol pour porte de garage	380
Anti-diefstal voor aanhangwagens - Antivol d'attelage universel	380
Afgrendeling - Fermeture	381-383
Manhole barriers - Manhole barriers	381-382
Confined space covers - Confined space covers	382
Skirt barriers - Skirt barriers	383
Multi barriers - Multi barriers	383
Index - Index	384-387

## CONTENU CATALOGUE

# REDDING & EVACUATIE - ISO 7010

# EVACUATION & SAUVETAGE - ISO 7010



			Fotolum Photolum			Haaks / En drapeau R/V		Haaks / En drapeau - R/V Fotolum / Photolum		
PP	VIN.	FOREX5mm	PVC	VIN.		PVC-1mm	PVC-1,5mm	PVC		
150x75	3120.P2	3130.P2	200x100	3027.P2	3037.P2	300x150	3172.P2	300x150 3062.P2		
200x100	3121.P2	3131.P2	300x150	3021.P2	3031.P2	400x200	3174.P2			
300x150	3122.P2	3132.P2	400x200	3022.P2	3032.P2					
400x200	3124.P2	3134.P2								
500x250					31E2.P2					
600x300	312E.P2				31E3.P2					
800x400					31E8.P2					
1000x500					31E9.P2					



Haaks / En drapeau R/V		Haaks / En drapeau - R/V Fotolum / Photolum		Plat	Plat R/V	Fotolum/Photolum Plat		Plat R/V	
PVC-1mm	PVC-1,5mm	PVC		Alu anod 1,5mm		Alu anod 1,5mm			
300x150	3172.P1PL	300x150	3062.P1PL	250x125	311C.P2	311T.P1	300x150	3A12.P2	3A1W.P1
400x200	3174.P1PL			300x150	3112.P2	311W.P1			



Plat R/V		Fotolum/Photolum Plat R/V		Zwarte eindkappen Finition noire		Fotolum - Zwarte eindkappen Photolum - Finition noire	
Alu anod 1,5mm		Alu anod 1,5mm		Alu anod 1,5mm		Alu anod 1,5mm	
250x125	311J.P2	300x150	3A1K.P2	250x125	31PC.P2	300x150 3AP2.P2	
300x150	311K.P2			300x150	31P2.P2		



Zwarte eindkappen - Haaks - R/V Finition noire - En drapeau - R/V		Fotolum - Zwarte eindkappen - Haaks - R/V Photolum - Finition noire - En drapeau - R/V		Zwarte eindkappen - Hangend - R/V Finition noire - Suspendu - R/V		Fotolum - Zwarte eindkappen - Hangend - R/V Photolum - Finition noire - Suspendu - R/V	
Alu anod 1,5mm		Alu anod 1,5mm		Alu anod 1,5mm		Alu anod 1,5mm	
250x125	31PJ.P1	300x150	3APK.P1	250x125	31PT.P1	300x150 3APW.P1	
300x150	31PK.P1			300x150	31PW.P1		



Plexi 6mm - Bevestigingen inbegr. Plexi 6mm - Fixations incl.		Plexi 6mm - Fotolum - Bevestigingen inbegr. Plexi 6mm - Photolum - Fixations incl.		Plexi 6mm - Zijwaarts - Bevestigingen inbegr. Plexi 6mm - Latéral - Fixations incl.		
Muur / Mur		Muur / Mur		Recto	R/V	
150x75	5140.P2	150x75	51A0.P2	300x150	5543.P2	5243.P2
300x150	5143.P2	300x150	51A3.P2			

EVACUATION & SAUVETAGE - ISO 7010

REDDING & EVACUATIE - ISO 7010

# REDDING & EVACUATIE ISO 7010 *EVACUATION & SAUVETAGE ISO 7010*



Plexi 6mm - Bevestigingen inbegr. Plexi 6mm - Fixations incl.	
Muur / Mur	
150x75	5140.P2
300x150	5143.P2



Plexi 6mm - Fotolum - Bevestigingen inbegr. Plexi 6mm - Photolum - Fixations incl.	
Muur / Mur	
150x75	51A0.P2
300x150	51A3.P2



Plexi 6mm - Zijwaarts - Bevestigingen inbegr. Plexi 6mm - Latéral - Fixations incl.		
Recto	R/V	
300x150	5543.P2	5243.P2



Plexi 6mm - Fotolum - Zijwaarts - Bevestigingen inbegr. Plexi 6mm - Photolum - Latéral - Fixations incl.		
Recto	R/V	
300x150	55A3.P2	52A3.P2



Plexi 6mm - Hangend - Bevestigingen inbegr. Plexi 6mm - Suspendu - Fixations incl.		
Recto	R/V	
300x150	5343.P2	5443.P2



Plexi 6mm - Fotolum - Hangend - Bevestigingen inbegr. Plexi 6mm - Photolum - Suspendu - Fixations incl.		
Recto	R/V	
300x150	53A3.P2	54A3.P2

EVACUATION & SAUVETAGE ISO 7010

## EEN GOEDE SIGNALISATIE VRAAGT OM EEN CORRECTE BEVESTIGING

## UNE BONNE SIGNALISATION DEMANDE UNE FIXATION CORRECTE

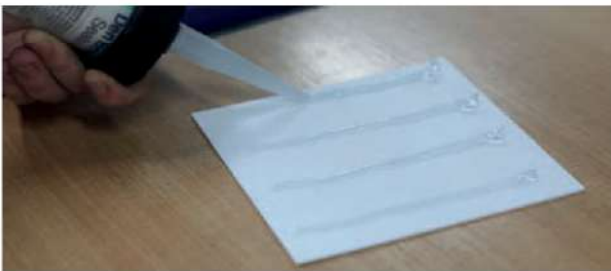

Groot gamma bevestigingsmaterialen

Grande gamme de matériaux de fixation



Tapes voor diverse applicaties  
Tapes pour applications divers



Een correcte verlijming zorgt voor een goede hechting.  
Un collage correct assure une bonne adhérence.

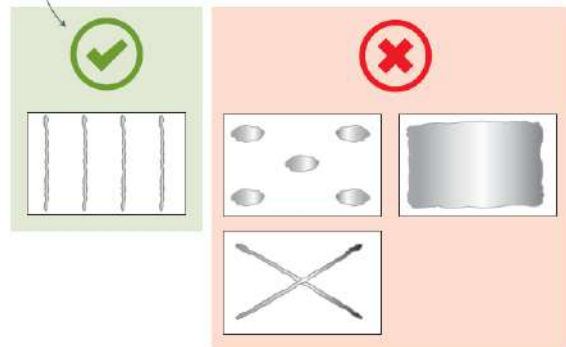

ONTDEK ONS UITGEBREIDE ASSORTIMENT  
BEVESTIGINGSMATERIALEN VANAF PAGINA 179

DÉCOUVREZ NOTRE ASSORTIMENT DE FIXATIONS  
ÉTENDU À PARTIR DE LA PAGE 179

REDDING EN EVACUATIE ISO 7010

# REDDING & EVACUATIE - ISO 7010

# EVACUATION & SAUVETAGE - ISO 7010



					Fotolum Photolum			Haaks / En drapeau R/V		Haaks / En drapeau - R/V Fotolum / Photolum	
PP	VIN.	PP-R/V	FOREX 5mm	FOREX R/N-5mm	PVC	VIN.	PVC - R/V	PVC-1mm	PVC-1,5mm		
150x75	3120.P1	3130.P1	31J0.P1		200x100	3027.P1	3037.P1	300x150	3172.P1	300x150	3062.P1
200x100	3121.P1	3131.P1	31J1.P1		300x150	3021.P1	3031.P1	30J1.P1	400x200	3174.P1	
300x150	3122.P1	3132.P1	31J2.P1		400x200	3022.P1	3032.P1				
400x200	3124.P1	3134.P1		31G1.P1							
500x250			31E2.P1	31G2.P1							
600x300	312E.P1		31E3.P1	31G3.P1							
800x400			31E8.P1	31G8.P1							
1000x500			31E9.P1	31G9.P1							



Haaks / En drapeau R/V		Muur Mur		Zijw.R. Lat.R.	Zijw. R/V Lat. R/V	Plaf. R.	Plaf. R/V	Fotolum Photolum	Muur Mur	Zijw.R. Lat.R.	Zijw. R/V Lat. R/V	Plaf. R.	Plaf. R/V
PVC-1mm	PVC-1,5mm	Plexi 6mm - Bevestigingen inbegr. / Fixations incl.						Plexi 6mm - Bevestigingen inbegr. / Fixations incl.					
300x150	3172.P1PL	150x75	5140.P1										
400x200	3174.P1PL	300x150	5143.P1	5543.P1	5243.P1	5343.P1	5443.P1	300x150	51A3.P1	55A3.P1	52A3.P1	53A3.P1	54A3.P1



Haaks / En drapeau - R/V Fotolum / Photolum		Plaf.	Plaf. R/V	Haaks / Drap. R/V	Prof.	Prof. Haaks Drap.R/V	Prof. Hang. Susp. R/V	Fotolum Photolum	Plaf.	Plaf. R/V	Haaks / Drap. R/V	Prof.	Prof. Haaks Drap.R/V	Prof. Hang. Susp. R/V	
PVC	Alu anod.	Alu anod.													
300x150	3062.P1PL	250x125	311C.P1	311T.P1	311J.P1	31PC.P1	31PJ.P1	31PT.P1	300x150	3A12.P1	3A1W.P1	3A1K.P1	3AP2.P1	3APK.P1	3APW.P1
		300x150	3112.P1	311W.P1	311K.P1	31P2.P1	31PK.P1	31PW.P1							



					Fotolum Photolum			Haaks / En drapeau R/V		Haaks / En drapeau - R/V Fotolum / Photolum		Haaks / En drapeau - R/V Fotolum / Photolum	
PP	VIN.	FOREX 5mm	PVC	VIN.	PVC-1mm			PVC-1mm			PVC-1mm		
150x75	3120.P3	3130.P3	200x100	3027.P3	3037.P3	300x150	3172.P3	300x150	3062.P3	300x150	3062.P3PL		
200x100	3121.P3	3131.P3	300x150	3021.P3	3031.P3								
300x150	3122.P3	3132.P3	400x200	3022.P3	3032.P3								
400x200	3124.P3	3134.P3											
500x250		31E2.P3											
600x300	312E.P3	31E3.P3											
800x400		31E8.P3											
1000x500		31E9.P3											



Haaks / En drapeau R/V		Muur Mur		Zijw.R. Lat.R.	Zijw. R/V Lat. R/V	Plaf. R.	Plaf. R/V	Fotolum Photolum	Muur Mur	Zijw.R. Lat.R.	Zijw. R/V Lat. R/V	Plaf. R.	Plaf. R/V
PVC-1mm	PVC-1,5mm	Plexi 6mm - Bevestigingen inbegr. / Fixations incl.						Plexi 6mm - Bevestigingen inbegr. / Fixations incl.					
300x150	3172.P3PL	300x150	5143.P3	5543.P3	5243.P3	5343.P3	5443.P3	300x150	51A3.P3	55A3.P3	52A3.P3	53A3.P3	54A3.P3
400x200	3174.P3PL												



Alle picto's kunnen, op aanvraag, met BARCODE worden geleverd, afzonderlijk (Ref.: BARC01) of gekleefd (Ref.: BARC02).  
Tous les pictos peuvent, sur demande, être livrés à CODE-BARRES séparément (réf.: BARC01) ou collés (réf.: BARC02).

# REDDING & EVACUATIE ISO 7010 EVACUATION & SAUVETAGE ISO 7010



Plat R/V	Haaks / Drap. R/V	Prof.	Prof. Haaks Drap. R/V	Prof. Hang. Susp. R/V	Plaf. R/V	Fotolum Photolum	Plat R/V	Haaks / Drap. R/V	Prof.	Prof. Haaks Drap. R/V	Prof. Hang. Susp. R/V				
Alu anod.					Alu anod.		Alu anod.								
250x125	311C.P3	311T.P3	311J.P3	31PC.P3	31PJ.P3	31PT.P3	300x150	311K.P3PL	300x150	3A12.P3	3A1W.P3	3A1K.P3	3AP2.P3	3APK.P3	3APW.P3
300x150	3112.P3	311W.P3	311K.P3	31P2.P3	31PK.P3	31PW.P3									



PP	VIN.	FOREX 5mm	Fotolum Photolum PVC	VIN.	Haaks / En drapeau Recto PVC-1mm	PVC-1,5mm	Muur Mur Plexi 6mm - Bevestigingen inbegr. / Fixations incl.	Haaks / En drapeau Recto	Plafond Recto		
200x100	3121.P4	3131.P4	200x100	3027.P4	3037.P4	300x150	3172.P4	300x150	5143.P4	5543.P4	5343.P4
300x150	3122.P4	3132.P4	300x150	3021.P4	3031.P4	400x200	3174.P4				
400x200	3124.P4	3134.P4	400x200	3022.P4	3032.P4						
500x250		31E2.P4									
600x300	312E.P4	31E3.P4									
800x400		31E8.P4									
1000x500		31E9.P4									



Fotolum Photolum	Muur Mur	Haaks / En drapeau Recto	Plafond Recto	Plat	Haaks / En drapeau Recto	Geprofileerd / Profilé	Prof. Haaks En drapeau Recto	Prof. Plafond Recto
Plexi 6mm - Bevestigingen inbegr. / Fixations incl.			Alu anod.					
300x150	51A3.P4	55A3.P4	53A3.P4	250x125	311C.P4	311J.P4	31PC.P4	31PJ.P4
				300x150	3112.P4	311K.P4	31P2.P4	31PK.P4
								31PT.P4
								31PW.P4



Fotolum Photolum	Plat	Haaks / En drapeau Recto	Geprofileerd / Profilé	Prof. Haaks En drapeau Recto	Prof. Plafond Recto
Alu anod.					
300x150	3A12.P4	3A1K.P4	3AP2.P4	3APK.P4	3APW.P4



Lam. Film pol.	Voor/Pour Picto	
125x125	100x100	VL0001
175x175	150x150	VL0002
225x225	200x200	VL0003
175x325	150x300	VL0004
175x425	150x400	VL0005
275x275	250x250	VL0006
225x425	200x400	VL0007
325x325	300x300	VL0008
425x425	400x400	VL0009
530x530	500x500	VL0010
630x630	600x600	VL0011

Beschermend laminaat voor vloerpicto  
Film protecteur pour picto-sol



PP	VIN.	PP-R/V	FOREX 5mm	FOREX R/V-5mm	Fotolum Photolum PVC	VIN.	Alu anod.	Haaks / Drap. R/V	Prof.	Prof. Haaks Drap. R/V		
150x75	3120.P5	3130.P5			200x100	3027.P5	250x125	311C.P5	311J.P5	31PC.P5	31PJ.P5	
200x100	3121.P5	3131.P5			300x150	3021.P5	3031.P5	300x150	3112.P5	311K.P5	31P2.P5	31PK.P5
300x150	3122.P5	3132.P5	31J2.P5		400x200	3022.P5						
400x200	3124.P5	3134.P5		31G1.P5								
500x250				31E2.P5								
600x300	312E.P5			31E3.P5								
800x400				31E8.P5								
1000x500				31E9.P5								

# REDDING & EVACUATIE - ISO 7010

# EVACUATION & SAUVETAGE - ISO 7010



Muur Mur	Zijw.R. Lat.R.	Plaf. R.	Plaf. R/V	Fotolum Photolum	Muur Mur	Zijw.R. Lat.R.	Plaf. R.	Plaf. R/V	Fotolum Photolum	Plaf.	Haaks / Drap. R/V	Prof.	Prof. Haaks Drap.R/V	
Plexi 6mm - Bevestigingen inbegr. / Fixations incl.				Plexi 6mm - Bevestigingen inbegr. / Fixations incl.				Alu anod.						
300x150	5143.P5	5543.P5	5343.P5	5443.P5	300x150	51A3.P5	55A3.P5	53A3.P5	54A3.P5	300x150	3A12.P5	3A1K.P5	3AP2.P5	3APK.P5



PP	VIN.	FOREX 5mm	Fotolum Photolum	PVC	Alu anod.	Plaf.	Haaks / Drap. R/V	Prof.	Prof. Haaks Drap.R/V
200x100	3121.P6	3131.P6	200x100	3027.P6	250x125	311C.P6	311J.P6	31PC.P6	31PJ.P6
300x150	3122.P6	3132.P6	300x150	3021.P6	300x150	3112.P6	311K.P6	31P2.P6	31PK.P6
400x200	3124.P6	3134.P6	400x200	3022.P6					
500x250		31E2.P6							
600x300	312E.P6	31E3.P6							
800x400		31E8.P6							
1000x500		31E9.P6							



Muur Mur	Zijw.R. Lat.R.	Plaf. R.	Plaf. R/V	Fotolum Photolum	Muur Mur	Zijw.R. Lat.R.	Plaf. R.	Plaf. R/V	Fotolum Photolum	Plaf.	Haaks / Drap. R/V	Prof.	Prof. Haaks Drap.R/V	
Plexi 6mm - Bevestigingen inbegr. / Fixations incl.				Plexi 6mm - Bevestigingen inbegr. / Fixations incl.				Alu anod.						
300x150	5143.P6	5543.P6	5343.P6	5443.P6	300x150	51A3.P6	55A3.P6	53A3.P6	54A3.P6	300x150	3A12.P6	3A1K.P6	3AP2.P6	3APK.P6



PP	VIN.	Fotolum Photolum	PVC	VIN	PP	VIN.	Fotolum Photolum	PVC	VIN
200x100	3121.P7	300x150	3021.P7	3031.P7	200x100	3121.P8	300x150	3021.P8	3031.P8
300x150	3122.P7	3132.P7	400x200	3022.P7	300x150	3122.P8	3132.P8	400x200	3022.P8
400x200	3124.P7	3134.P7			400x200	3124.P8	3134.P8		



PP	VIN.	Fotolum Photolum	PVC	VIN	PP	VIN.	Fotolum Photolum	PVC	VIN	
200x100	3121.P9	3131.P9	300x150	3021.P9	3031.P9	200x100	3121.Q1	300x150	3021.Q1	3031.Q1
300x150	3122.P9	3132.P9	400x200	3022.P9	300x150	3122.Q1	3132.Q1	400x200	3022.Q1	
400x200	3124.P9	3134.P9			400x200	3124.Q1	3134.Q1			



PP	VIN.	PP	VIN.	PP	VIN.	PP	VIN.	
450x150	313A.B2	312A.B2	450x150	313A.B3	312A.B3	450x150	313A.B4	312A.B4
600x200	313B.B2	312B.B2	600x200	313B.B3	312B.B3	600x200	313B.B4	312B.B4
						600x200	313B.B7	312B.B7

EVACUATION & SAUVETAGE - ISO 7010

REDDING & EVACUATIE - ISO 7010

# REDDING & EVACUATIE ISO 7010

# EVACUATION & SAUVETAGE ISO 7010



PP		VIN.		PP		VIN.		PVC		PVC	
450x150	313A.B6	312A.B6		450x150	313A.B5	312A.B5		450x150	302A.65	450x150	302A.66
600x200	313B.B6	312B.B6		600x200	313B.B5	312B.B5		600x200	302B.65	600x200	302B.66



PVC		PVC		PVC		PVC	
450x150	302A.67	450x150	302A.71	450x150	302A.70	450x150	302A.69
600x200	302B.67	600x200	302B.71	600x200	302B.70	600x200	302B.69



			Fotolum / Photolum			Alu anod.			Alu anod. - Fotolum / Alu anod. - Photolum		
PP	VIN.	FOREX R/V-5mm	PVC	VIN		Plat	Prof.	Prof. Hang. / Susp.R/V	Plat	Prof.	
100x100	3120.08	3130.08	75x75	303G.08		125x125 311B.08	31PB.08	31PS.08	150x150	3A1A.08	3APA.08
150x150	3121.08	3131.08	100x100	3020.08	3030.08	150x150 311A.08	31PA.08	31PU.08			
200x200	3122.08	3132.08	150x150	3026.08	3036.08						
250x250	3123.08	3133.08	200x200	3021.08	3031.08						
300x300	3124.08	3134.08									
400x400	3125.08										
500x500	3126.08	3136.08									



			Fotolum / Photolum			Fotolum / Photolum					
PP	VIN.		PVC	VIN		PP	VIN.	Spiegelbeeld VIN / VIN Image réfléchie	PP-R/V	Signicolor 1,5mm	
150x150	3121.59	3131.59	150x150	3026.23		50x50	313C.09				
200x200	3122.59	3132.59	200x200	3021.23		100x100	3120.09	3130.09			
250x250	3123.59	3133.59				150x150	3121.09	3131.09			31J1.09
						200x200	3122.09	3132.09			31J2.09
						250x250	3123.09	3133.09			
						300x300	3124.09	3134.09			3114.09
						400x400	3125.09	3135.09			31J5.09
						500x500	3126.09	3136.09			



Fotolum Photolum		Panoram. Panoram.		Panoram. - Fotolum Panoram. - Photolum	
PVC	VIN	PVC-1mm		PVC	
100x100	3020.09	3030.A9	200x100	312P.99	3023.09
150x150	3026.09	3036.A9	300x150	3124.99	400x200 3024.09
200x200	3021.09	3031.09	400x200	3125.99	



Haaks - R/V En drapeau - R/V		Haaks - Fotolum - R/V En drapeau - Photolum - R/V		Alu anod. Alu anod.		Alu anod. - Fotolum Alu anod. - Photolum		Plexi 6mm - Bevestigingen inbegr. Plexi 6mm - Fixations incl.	
PVC-1mm	PVC-1,5mm	PVC		Plat		Plat		Muur-Muur	
150x150	3171.09	200x200	3072.09	125x125	311B.09	150x150	3A1A.09	150x150	5141.09
200x200	3172.09			150x150	311A.09			200x200	5142.09
250x250	3173.09								

# REDDING & EVACUATIE ISO 7010

# EVACUATION & SAUVETAGE ISO 7010

EVACUATION & SAUVETAGE - ISO 7010



				Fotolum Photolum			Panoram. Panoram.		Panoram. - Fotolum Panoram. - Photolum	
PP	VIN.	PP-R/V	Signicolor 1,5mm	PVC	VIN.		PVC-1mm		PVC	
100x100	3120.10	3130.10		100x100	3020.10	3030.10	300x150	3124.10P	400x200	3024.10
150x150	3121.10	3131.10	31J1.10	150x150	3026.10	3036.10	400x200	3125.10P		
200x200	3122.10	3132.10		200x200	3021.10	3031.10				
250x250	3123.10	3133.10								
300x300	3124.10	3134.10	3114.10							
400x400	3125.10									
500x500	3126.10									



Haaks - R/V En drapeau - R/V							Fotolum Photolum			Panoram. Panoram.	
PVC-1mm			PP	VIN.	Signicolor 1,5mm	PVC	VIN.		PVC-1mm		
200x200	3172.10		50x50	313C.11		100x100	3020.11	3030.11	300x150	3124.11P	
			100x100	3120.11	3130.11	150x150	3026.11		400x200	3125.11P	
			150x150	3121.11	3131.11	200x200	3021.11	3031.11			
			200x200	3122.11	3132.11						
			250x250	3123.11	3133.11						
			300x300	3124.11	3134.11	3114.11					
			400x400	3125.11							
			500x500	3126.11							



Panoram. - Fotolum Panoram. - Photolum		Haaks - R/V En drapeau - R/V		Plexi 6mm - Bevestigingen inbegr. Plexi 6mm - Fixations incl.		PP		VIN.	
PVC		PVC-1mm		Muur-Muur					
300x150	3023.11	200x200	3172.11	150x150	5141.11	150x150	3121.AB	3131.AB	
400x200	3024.11			200x200	5142.11	200x200	3122.AB	3132.AB	



				Fotolum Photolum			Panoram. Panoram.		Panoram. - Fotolum Panoram. - Photolum	
PP	VIN.	Greenline		PVC	VIN.		PVC-1mm		PVC	
100x100	3120.12	3130.12		100x100	3020.12	3030.12	400x200	3125.12P	400x200	3024.12
150x150	3121.12	3131.12	31U1.12	150x150	3026.12					
200x200	3122.12	3132.12		200x200	3021.12					
250x250	3123.12	3133.12								
400x400	3135.12									



Haaks - R/V En drapeau - R/V		Plexi 6mm - Bevestigingen inbegr. Plexi 6mm - Fixations incl.				PP		VIN.	
PVC-1mm		Muur-Muur							
150x150	3171.12	150x150	5141.12	150x150	3121.BH	3131.BH	150x150	3121.AC	3131.AC
200x200	3172.12	200x200	5142.12	200x200	3122.BH	3132.BH	200x200	3122.AC	3132.AC

REDDING & EVACUATIE - ISO 7010

# REDDING & EVACUATIE ISO 7010

# EVACUATION & SAUVETAGE ISO 7010



			Fotolum / Photolum			Haaks - R/V / En drapeau - R/V		
PP	VIN.		PP	VIN.		PVC	PVC-Imm	
150x150	3121.AD	3131.AD	100x100	3120.50	3130.50	100x100	3020.50	
200x200	3122.AD	3132.AD	150x150	3121.50	3131.50	150x150	3026.50	
			200x200	3122.50	3132.50	200x200	3021.50	
			250x250	3123.50	3133.50			



Panoram.		Plexi 6mm - Bevestigingen Inbegr. / Mur Fixations incl.							
PVC-Imm		Muur / Mur		PP	VIN.		PP	VIN.	
400x200	3125.50	150x150	5141.13	150x150	3121.G7	3131.G7	100x100	3120.AA	3130.AA
		200x200	5142.13				150x150	3121.AA	3131.AA
							200x200	3122.AA	3132.AA



			Panoram.		Haaks - R/V / En drapeau - R/V				
PP	VIN.		PVC-Imm		PVC-Imm		PP	VIN.	
100x100	3130.88		200x100	312P.88	200x200	3172.88	150x150	3121.13	3131.13
150x150	3121.88	3131.88	300x150	3124.88			200x200	3122.13	3132.13
200x200	3122.88	3132.88	400x200	3125.88			250x250	3123.13	3133.13



Fotolum / Photolum			Panoram.		Fotolum / Photolum		
PVC	VIN.		PVC-Imm		PP	VIN.	
100x100	3030.F4		400x200	3125.13P	100x100	3120.Q2	3130.Q2
150x150	3026.13				150x150	3121.Q2	3131.Q2
					200x200	3122.Q2	3132.Q2



PP	VIN.		PVC	VIN.		PP	VIN.		PP	VIN.	
100x100	3120.Q3	3130.Q3	100x100	3020.Q3	3030.Q3	150x200	3122.G1	3132.G1	100x100	3120.Q4	3130.Q4
150x150	3121.Q3	3131.Q3	150x150	3026.Q3	3036.Q3				150x150	3121.Q4	3131.Q4
200x200	3122.Q3	3132.Q3							200x200	3122.Q4	3132.Q4



Fotolum / Photolum			Fotolum / Photolum			Fotolum / Photolum					
PVC	VIN.		PP	VIN.		PVC	VIN.		PP	VIN.	
100x100	3020.Q4	3030.Q4	100x100	3120.Q5	3130.Q5	100x100	3020.Q5	3030.Q5	100x100	3120.Q6	3130.Q6
150x150	3026.Q4	3036.Q4	150x150	3121.Q5	3131.Q5	150x150	3026.Q5	3036.Q5	150x150	3121.Q6	3131.Q6
			200x200	3122.Q5	3132.Q5				200x200	3122.Q6	3132.Q6

# REDDING & EVACUATIE ISO 7010

# EVACUATION & SAUVETAGE ISO 7010

EVACUATION & SAUVETAGE - ISO 7010



Fotolum / Photolum			Fotolum / Photolum			Fotolum / Photolum			Fotolum / Photolum		
PVC	VIN.		PP	VIN.		PVC	VIN.		PP	VIN.	
100x100	3020.Q6	3030.Q6	100x100	3120.G2	3130.G2	100x100	3020.G2	3030.G2	100x100	3120.BA	3130.BA
150x150	3026.Q6	3036.Q6	200x200	3122.G2	3132.G2	150x150	3026.G2	3036.G2	200x200	3122.BA	3132.BA



Fotolum / Photolum			Fotolum / Photolum			Fotolum / Photolum			Fotolum / Photolum		
PVC	VIN.		PP	VIN.		PVC	VIN.		PP	VIN.	
100x100	3020.BA	3030.BA	100x100	3120.BB	3130.BB	100x100	3020.BB	3030.BB	100x100	3120.BC	3130.BC
150x150	3026.BA	3036.BA	200x200	3122.BB	3132.BB	150x150	3026.BB	3036.BB	200x200	3122.BC	3132.BC



Fotolum / Photolum			Fotolum / Photolum			Fotolum / Photolum			Fotolum / Photolum		
PVC	VIN.		PP	VIN.		PVC	VIN.		PP	VIN.	
100x100	3020.BC	3030.BC	100x100	3120.BD	3130.BD	100x100	3020.BD	3030.BD	100x100	3120.BE	3130.BE
150x150	3026.BC	3036.BC	200x200	3122.BD	3132.BD	150x150	3026.BD	3036.BD	200x200	3122.BE	3132.BE



Fotolum / Photolum			Fotolum / Photolum			Fotolum / Photolum			Alu anod.		
PVC	VIN.		PP	VIN.		PVC	VIN.		Plat		
100x100	3020.BE	3030.BE	100x100	3120.75	3130.75	150x150	3026.75	3036.75	150x150 311A.75		
150x150	3026.BE	3036.BE	150x150	3121.75	3131.75	200x200	3021.75	3031.75			
			200x200	3122.75	3132.75						
			250x250	3123.75	3133.75						



Fotolum / Photolum			Fotolum / Photolum			Alu anod.			Fotolum / Photolum		
PP	VIN.		PVC	VIN.		Plat			PP	VIN.	
100x100	3120.76	3130.76	150x150	3026.76	3036.76	150x150 311A.76			150x150	3121.M5	3131.M5
150x150	3121.76	3131.76	200x200	3021.76	3031.76				200x200	3122.M5	3132.M5
200x200	3122.76	3132.76									
250x250	3123.76	3133.76									



Fotolum / Photolum			Fotolum / Photolum			Fotolum / Photolum			Fotolum / Photolum		
PP	VIN.		PP	VIN.		PP	VIN.		PP	VIN.	
150x150	3121.M6	3131.M6	50x50	313C.AE		150x150	3121.AF	3131.AF	150x150	3121.AG	3131.AG
200x200	3122.M6	3132.M6	100x100	3120.AE	3130.AE	200x200	3122.AF	3132.AF	200x200	3122.AG	3132.AG
			150x150	3121.AE	3131.AE						



Fotolum / Photolum			Fotolum / Photolum			Fotolum / Photolum			Fotolum / Photolum		
PP	VIN.		PP	VIN.		PP	VIN.		PP	VIN.	
150x150	3121.AH	3131.AH	150x150	3121.AI	3131.AI	150x150	3121.AJ	3131.AJ	150x150	3121.AK	3131.AK
200x200	3122.AH	3132.AH	200x200	3122.AI	3132.AI	200x200	3122.AJ	3132.AJ	200x200	3122.AK	3132.AK

REDDING & EVACUATIE - ISO 7010

# REDDING & EVACUATIE ISO 7010

# EVACUATION & SAUVETAGE ISO 7010



	PP	VIN.
150x150	3121.AL	3131.AL
200x200	3122.AL	3132.AL

	PP	VIN.
150x150	3121.AM	3131.AM
200x200	3122.AM	3132.AM

	PP	VIN.
150x150	3121.AN	3131.AN
200x200	3122.AN	3132.AN

	PP	VIN.
150x150	3121.AP	3131.AP
200x200	3122.AP	3132.AP



	PP	VIN.
150x150	3121.AQ	3131.AQ
200x200	3122.AQ	3132.AQ

	PP	VIN.
150x150	3121.N2	3131.N2
200x200	3122.N2	3132.N2
300x300	3123.N2	3133.N2

	PP	VIN.
150x150	3121.AR	3131.AR
200x200	3122.AR	3132.AR

	PP	VIN.
150x150	3121.AS	3131.AS
200x200	3122.AS	3132.AS



	PP	VIN.
150x150	3121.AT	3131.AT
200x200	3122.AT	3132.AT

	PP	VIN.
150x150	3121.AU	3131.AU
200x200	3122.AU	3132.AU

	PP	VIN.
150x150	3121.AV	3131.AV
200x200	3122.AV	3132.AV

	PP	VIN.
150x150	3121.AW	3131.AW
200x200	3122.AW	3132.AW



	PP	VIN.
150x150	3121.AX	3131.AX
200x200	3122.AX	3132.AX

	PP	VIN.
150x150	3121.AY	3131.AY
200x200	3122.AY	3132.AY

	PP	VIN.
150x150	3121.AZ	3131.AZ
200x200	3122.AZ	3132.AZ

	PP	VIN.
150x150	3121.BF	3131.BF
200x200	3122.BF	3132.BF
400x400	3125.BF	3135.BF



Scheepsplatform  
Pont



	PP	VIN.
150x150	3121.BG	3131.BG
200x200	3122.BG	3132.BG
400x400	3125.BG	3135.BG

	PP	VIN.
150x150	3120.R0	3130.R0
200x200	3121.R0	3131.R0



Andere formaten of materialen op aanvraag.  
Autres dimensions ou matériaux sur demande.

EEN BOEI OF EEN VEST KAN UW LEVEN REDDEN  
UNE BOUÉE OU UN GILET DE SAUVETAGE PEUT  
VOUS SAUVER LA VIE



PAG. 76

DE IMO-VERSIE NODIG VAN DEZE PICTOGRAMMEN?  
BESOIN DE LA VERSION IMO DE  
CES PICTOGRAMMES?

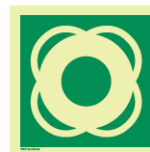

Muster station



Line-throwing  
appliance

PAG. 78 - 87



			Fotolum / Photolum			Panoram.		Panoram. Fotolum / Panoram. Photolum	
PP	VIN.	Alu.	PVC	VIN.		PVC-1mm		PVC	
50x50	313C.Q7	311B.Q7	125x125			200x100	312P.Q7	400x200	3024.Q7
100x100	3120.Q7	3130.Q7	150x150	3026.Q7		300x150	3124.Q7P		
150x150	3121.Q7	3131.Q7	200x200	3021.Q7	3031.Q7	400x200	3125.Q7		
200x200	3122.Q7	3132.Q7							
250x250	3123.Q7	3133.Q7							
300x300	3124.Q7	3134.Q7							



Haaks - R/V En drapeau - R/V		Haaks - Fotolum - R/V En drapeau - Photolum - R/V		4D - REFL. - KLASSE I - 4 Zijden 4D - REFL. - CLASSE I - 4 Faces		3D - REFL. - KLASSE I - 3 Zijden 3D - REFL. - CLASSE I - 3 Faces	
PVC-1mm		PVC		Alu PL		T2000	
100x100	3175.Q7	150x150	3071.Q7	400x400	31X4.Q7	400x400	31Y4.Q7
150x150	3171.Q7	200x200	3072.Q7	Voor paal - Pour poteau Ø 76mm		Voor paal - Pour poteau Ø 51mm	

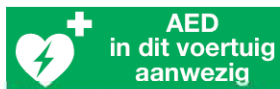

PP		Spiegelbeeld VIN VIN Image réfléchie		PP		Spiegelbeeld VIN VIN Image réfléchie		PP		VIN.	
300x100	3128.Q8	3138.Q8	31A8.Q8	300x100	3128.J2	3138.J2	31A8.J2	150x200	3122.J3	3132.J3	
								150x200	3122.J4	3132.J4	

## Defibrillatoren

## Défibrillateurs



Philips Heartstart Home

- Met opbergtas en safeset
- Inclusief :
  - SMART-elektrodestickers voor volwassenen (gaan 2 jaar mee)
  - Batterij (4 jaar of 200 schokken)
- 8 jaar garantie

- Avec sac de rangement et safeset
- Y compris :
  - Autocollants-électrodes SMART pour adultes (durée 2 années)
  - Batterie (4 ans ou 200 chocs)
- 8 ans de garantie



Philips Heartstart FRX

- Met opbergtas en safeset
- Inclusief :
  - SMART-elektrodestickers voor volwassenen (gaan 2 jaar mee)
  - Batterij (4 jaar of 200 schokken)
- 8 jaar garantie

- Avec sac de rangement et safeset
- Y compris :
  - Autocollants-électrodes SMART pour adultes (durée 2 années)
  - Batterie (4 ans ou 200 chocs)
- 8 ans de garantie



Defibtech lifeline AED

- Met safeset
- Inclusief :
  - Defibrillatie-elektroden voor volwassenen (gaan 2 jaar mee)
  - Batterij (7 jaar of 300 schokken)
- 8 jaar garantie

- Avec safeset
- Y compris :
  - Electrodes-défibrillation pour adultes (durée 2 années)
  - Batterie (7 ans ou 300 chocs)
- 8 ans de garantie



Defibtech lifeline view

- Full colour display
- Met safeset
- Inclusief :
  - Defibrillatie-elektroden voor volwassenen (gaan 2 jaar mee)
  - Batterij (4 jaar of 125 schokken)
- 8 jaar garantie

- Display full colour
- Avec safeset
- Y compris :
  - Electrodes-défibrillation pour adultes (durée 2 années)
  - Batterie (4 ans ou 125 chocs)
- 8 ans de garantie

Prijzen steeds op aanvraag

Prix sur demande

## Verzamelaars

## Point de rassemblement



				Fotolum Photolum		Haaks - R/V En drapeau - R/V		Panoram. Panoram.	
PP	VIN.	Signicolor 1,5mm	DIBOND 3mm	PVC		PVC-15mm		PVC-1mm	
150x150	3121.Q0	3131.Q0	311A.Q0	150x150	3026.Q0	250x250	3173.Q0	300x150	3124.Q0P
200x200	3122.Q0	3132.Q0		200x200	3021.Q0	400x400	3176.Q0	400x200	3125.Q0P
250x250	3123.Q0	3133.Q0		300x300	3022.Q0				
300x300	3124.Q0	3134.Q0	3114.Q0	400x400	3025.Q0				
400x400	3125.Q0	3135.Q0	3115.Q0						
500x500	3126.Q0	3136.Q0							
600x600	3127.Q0		3117.Q0						



Alu - Type 2000		Alu - Type 2000		Alu - Type 2000		Alu - Type 2000		BEUGEL-2 beugels per T2000/3D/4D bord BRIDE - 2 brides par panneau T2000/3D/4D	
400x400	31V4.Q0	400x600	31V8.L0	400x600	31V8.L1	400x600	K6415.MTG	ø51mm	K3104
600x600	31V6.Q0							ø76mm	K3204
700x700	31V7.Q0								



4D - REFL. - KLASSE I - 4 Zijden 4D - REFL. - CLASSE I - 4 Faces		3D - REFL. - KLASSE I - 3 Zijden 3D - REFL. - CLASSE I - 3 Faces	
Alu Pl.		T.2000	
400x400	31X4.Q0	400x400	31Y4.Q0
			Alu Pl. 31Z4.Q0

Bij de 3D en 4D bordes zijn de beugels niet inbegrepen.  
Pour les panneaux 3D et 4D les brides ne sont pas incluses.

## Palen & Toebehoren

## Poteaux & Accessoires

### Palen Poteaux

Lengte Longueur	Galva	
	Diam. 51mm	Diam. 76mm
2500mm	K3114	K3214
3000mm	K3115	K3215
3500mm	K3116	K3216
4000mm	K3117	K3217

### Paaldoppen Calottes

Diam. Diam.	
51mm	K3101
76mm	K3201



### Haakse bevestigingsarm met dop Bras en drapeau avec calotte

Lengte Longueur	Diam 76mm
600mm	WH6D
400mm	WH76



### Bevestigingsarm vork Bras support fourche

Lengte Longueur	Diam 60mm
960mm	WHX2



### Paalvoeten Pieds d'encrage

Diam. Diam.	Gew. Poids	Beton Beton
51mm	33kg	K3108
76mm	52kg	K3208



Bevestigen op een paal met max ø80mm  
A fixer sur un poteau de max ø80mm

# REDDING & EVACUATIE

# EVACUATION & SAUVETAGE



	PP	VIN.	FOREX 5mm
150x75	3120.02	3130.02	
200x100	3121.02	3131.02	
300x150	3122.02	3132.02	
400x200	3124.02	3134.02	
500x250			31E2.02
600x300			31E3.02
800x400			31E8.02
1000x500			31E9.02



Fotolum Photolum		
	PVC	VIN
200x100	3027.02	3037.02
300x150	3021.02	3031.02
400x200	3022.02	3032.02



Haaks - R/V En drapeau - RV		
	PVC - 1mm	PVC - 1,5mm
300x150	3172.02	
400x200		3174.02



Haaks - Fotolum - R/V En drapeau - Photolum - RV	
	PVC
300x150	3062.02



Alu anod. Alu anod.		Haaks Drap. R/V		Prof. Haaks Drap. R/V	
	Plat				
250x125	311C.02	311J.02	31PC.02	31PJ.02	
300x150	3112.02	311K.02	31P2.02	31PK.02	



Alu anod. - Fotolum Alu anod. - Photolum			
	Plat	Haaks Drap. R/V	Prof.
300x150	3A12.02	3A1K.02	3AP2.02



Plexi 6mm - Bevestigingen Inbegr. Plexi 6mm - Fixations incl.				
	Muur Mur	Zijw.R. Lat.R.	Plaf. R.	Plaf. R/V
150x75	5140.02		5343.02	5443.02
300x150	5143.02	5543.02		



Plexi 6mm - Fotolum - Bevestigingen Inbegr. Plexi 6mm - Photolum - Fixations incl.				
	Muur Mur	Zijw.R. Lat.R.	Plaf. R.	Plaf. R/V
150x75	51A0.02		53A3.02	54A3.02
300x150	51A3.02	55A3.02		



	PP	VIN.	PP-R/V	FOREX 5mm	FOREX R/V-5mm
150x75	3120.01	3130.01	31J0.01		
200x100	3121.01	3131.01	31J1.01		
300x150	3122.01	3132.01	31J2.01		
400x200	3124.01	3134.01			31G1.01
500x250				31E2.01	31G2.01
600x300	312E.01			31E3.01	31G3.01
800x400				31E8.01	31G8.01
1000x500				31E9.01	31G9.01



Fotolum Photolum		
	PVC	VIN
200x100	3027.01	3037.01
300x150	3021.01	3031.01
400x200	3022.01	3032.01



Haaks - R/V En drapeau - RV		
	PVC - 1mm	PVC - 1,5mm
300x150	3172.01	
400x200		3174.01



Plafond - RV Plafond - RV	
	PVC - 1mm
300x150	3172.01PL
400x200	3174.01PL



Haaks - Fotolum - RV En drapeau - Photolum - RV	
	PVC
300x150	3062.01



Plafond - Fotolum - RV Plafond - Photolum - RV	
	PVC
300x150	3062.01PL

# REDDING & EVACUATIE

# EVACUATION & SAUVETAGE



Alu anod.	Plat	R/V Haaks Drap.	Plat R/V	Prof.	R/V Prof. Haaks Drap.	R/V Prof. Hang. Susp.	R/V Haaks Drap. Plaf.
250x125	311C.01	311J.01	311T.01	31PC.01	31PJ.01	31PT.01	311J.01PL
300x150	3112.01	311K.01	311W.01	31P2.01	31PK.01	31PW.01	311K.01PL

Alu anod. - Fotolum	Plat	R/V Haaks Drap.	Prof.	R/V Prof. Haaks Drap.	R/V Prof. Hang. Susp.
300x150	3A12.01	3A1W.01	3A1K.01	3AP2.01	3APK.01
				3APW.01	



Plexi 6mm - Bevestigingen inbegr.  
Plexi 6mm - Fixations incl.

Plexi 6mm - Fotolum - Bevestigingen inbegr.  
Plexi 6mm - Photolum - Fixations incl.

	Muur/Mur	Zijw. R. Lat. R.	Zijw. R/V Lat. R/V	Plaf. R.	Plaf. R/V
150x75	5140.01				
300x150	5143.01	5543.01	5243.01	5343.01	5443.01

	Muur/Mur	Zijw. R. Lat. R.	Zijw. R/V Lat. R/V	Plaf. R.	Plaf. R/V
150x75	51A0.01				
300x150	51A3.01	55A3.01	52A3.01	53A3.01	54A3.01



	PP	VIN.	FOREX 5mm
150x75	3120.60	3130.60	
200x100	3121.60	3131.60	
300x150	3122.60	3132.60	
400x200	3124.60	3134.60	
500x250			31E2.60
600x300	312E.60		31E3.60
800x400			31E8.60
1000x500			31E9.60

Fotolum Photolum	PVC	VIN
200x100	3027.60	
300x150	3021.60	3031.60
400x200	3022.60	3032.60

Haaks - R/V En drapeau - R/V	PVC - 1mm
300x150	3172.60



Plafond - R/V	PVC - 1mm
300x150	3172.60PL

**Beschermend laminaat voor vloerpicto**  
**Film protecteur pour picto-sol**

Lam. Film pol.	Voor/Pour Picto	
200x200	150x150	LA32.00
350x200	300x150	LA33.00
250x250	200x200	LA34.00
450x250	400x200	LA35.00

Plafond - Fotolum - R/V	PVC
300x150	3062.60PL



Alu anod.	Plat	Plat R/V	R/V Haaks Drap.	Prof.	R/V Prof. Haaks Drap.	R/V Prof. Hang. Susp.
250x125	311C.60	311T.60	311J.60	31PC.60	31PJ.60	31PT.60
300x150	3112.60	311W.60	311K.60	31P2.60	31PK.60	31PW.60

Alu anod. - Fotolum	Plat	R/V Haaks Drap.
300x150	3A12.60	3A1W.60
		3A1K.60



Plafond - R/V	Muur/Mur	Zijw. R. Lat. R/V	Plaf. R/V
300x150	5143.05	5243.05	5443.05

Plafond - Fotolum - R/V	Muur/Mur	Zijw. R. Lat. R/V	Plaf. R/V
300x150	51A3.05	52A3.05	54A3.05

## REDDING & EVACUATIE



	PP	VIN.	FOREX 5mm
200x100	3121.61	3131.61	
300x150	3122.61	3132.61	
400x200	3124.61	3134.61	
500x250			31E2.61
600x300	312E.61		31E3.61
800x400			31E8.61
1000x500			31E9.61



Fotolum Photolum		
	PVC	VIN
200x100	3027.61	
300x150	3021.61	3031.61
400x200	3022.61	



Haaks - R/V En drapeau - R/V		
	PVC-1mm	PVC-1,5mm
300x150	3172.61	
400x200		3174.61



Alu anod.  
Alu anod.

	Plat	Plat R/V	Haaks Drap. R/V	Prof.	Prof. Haaks Drap. R/V	Prof. Hang. Susp. R/V
250x125	311C.61	311T.61	311J.61	31PC.61	31PJ.61	31PT.61
300x150	3112.61	311W.61	311K.61	31P2.61	31PK.61	31PW.61



Alu anod. - Fotolum  
Alu anod. - Photolum

	Plat	Plat R/	Haaks Drap. R/V	Prof. Haaks Drap. R/V	Prof. Hang. Susp. R/V
300x150	3A12.61	3A1W.61	3A1K.61	3APK.61	3APW.61



Plexi 6mm - Bevestigingen inbegr.  
Plexi 6mm - Fixations incl.

	Muur Mur	Zijw. R/V Lat. R/V	Plaf. R/V
300x150	5143.06	5243.06	5443.06



Alle picto's kunnen, op aanvraag, met BARCODE worden geleverd, afzonderlijk (Ref.: BARC01) of gekleefd (Ref.: BARC02).

Tous les pictos peuvent, sur demande, être livrés à CODE-BARRES séparément (Ref.: BARC01) ou collés (Ref.: BARC02).



Plexi 6mm - Fotolum - Bevestigingen inbegr.  
Plexi 6mm - Photolum - Fixations incl.

	Muur Mur	Zijw. R/V Lat. R/V	Plaf. R/V
150x75	51A0.06		
300x150	51A3.06	52A3.06	54A3.06



Fotolum Photolum		
	PVC	VIN
200x100	3027.62	
300x150	3021.62	3031.62
400x200	3022.62	

	PP	VIN.	PP-R/V	FOREX 5mm	FOREX R/V-5mm
150x75	3120.62				
200x100	3121.62	3131.62			
300x150	3122.62	3132.62	31J2.62		
400x200	3124.62	3134.62			31G1.62
500x250				31E2.62	
600x300	312E.62			31E3.62	
800x400				31E8.62	
1000x500				31E9.62	



Alu anod. Alu anod.			Haaks Drap. R/V	Prof.	Prof. Haaks Drap. R/V
	Plat				
250x125	311C.62	311J.62	311K.62	31PC.62	31PJ.62
300x150	3112.62	311K.62		31P2.62	31PK.62



Alu anod. - Fotolum  
Alu anod. - Photolum

	Plat	Haaks Drap. R/V	Prof.	Prof. Haaks Drap. R/V
300x150	3A12.62	3A1K.62	3AP2.62	3APK.62



Plexi 6mm - Bevestigingen inbegr.  
Plexi 6mm - Fixations incl.

	Muur Mur	Plaf. R/V
300x150	5143.07	5443.07



Plexi 6mm - Fotolum - Bevestigingen inbegr.  
Plexi 6mm - Photolum - Fixations incl.

	Muur Mur	Plaf. R/V
300x150	51A3.07	54A3.07

# REDDING & EVACUATIE



	PP	VIN.	FOREX 5mm
200x100	3121.63	3131.63	
300x150	3122.63	3132.63	
400x200	3124.63	3134.63	
500x250			31E2.63
600x300			31E3.63
800x400			31E8.63
1000x500			31E9.63



Alu anod. - Fotolum Alu anod. - Photolum	Plat	R/V Haaks Drap.	Prof.	R/V Prof. Haaks Drap.
300x150	3A12.63	3A1K.63	3AP2.63	3APK.63



	PP	VIN.
300x150	3122.84	3132.84
400x200	3124.84	3134.84



Fotolum Photolum	PVC	VIN
300x150	3021.85	3031.85
400x200	3022.85	



	PP	VIN.
300x150	3122.87	3132.87
400x200	3124.87	3134.87



Fotolum Photolum	PVC	VIN
200x100	3027.18	
300x150	3021.18	
400x200	3022.18	



Fotolum Photolum	PVC
200x100	3027.63
300x150	3021.63
400x200	3022.63



Plexi 6mm - Bevestigingen inbegr. Plexi 6mm - Fixations incl.	Muur/Mur	Plaf. R/V
300x150	5143.08	5443.08



Fotolum Photolum	PVC	VIN
300x150	3021.84	3031.84
400x200	3022.84	



	PP	VIN.
300x150	3122.86	3132.86
400x200	3124.86	3134.86



Fotolum Photolum	PVC	VIN
300x150	3021.87	3031.87
400x200	3022.87	



Alu anod. Alu anod.	Plat	Prof.
250x125	311C.18	31PC.18
300x150	3112.18	31P2.18

# EVACUATION & SAUVETAGE



Alu anod. Alu anod.	Plat	R/V Haaks Drap.	Prof.	R/V Prof. Haaks Drap.
250x125	311C.63	311J.63	31PC.63	31PJ.63
300x150	3112.63	311K.63	31P2.63	31PK.63



Plexi 6mm - Fotolum - Bevestigingen inbegr. Plexi 6mm - Photolum - Fixations incl.	Muur/Mur	Plaf. R/V
300x150	51A3.08	54A3.08



	PP	VIN.
300x150	3122.85	3132.85
400x200	3124.85	3134.85



Fotolum Photolum	PVC	VIN
300x150	3021.86	3031.86
400x200	3022.86	



	PP	VIN.	PP-R/V
200x100	3121.18	3131.18	31J1.18
297x105	3128.18	3138.18	
300x150	3122.18	3132.18	31J2.18
400x200	3124.18	3134.18	



Gebruik voor de plaatsing van PP pictogrammen  
steeds zuurvrije verlijmers.

Utilisez toujours pour le placement des  
pictogrammes PP des produits sans acides.

# REDDING & EVACUATIE

# EVACUATION & SAUVETAGE



	PP	VIN.
200x100	3121.19	3131.19
297x105	3128.19	3138.19
300x150	3122.19	3132.19
400x200	3124.19	3134.19

**Fotolum  
Photolum**

	PVC	VIN
200x100	3027.19	
300x150	3021.19	3031.19
400x200	3022.19	3032.19

**Haaks - RV  
En drapeau - RV**

	PVC-1mm
300x150	3172.19

**Plafond - RV  
Plafond - RV**

	PVC-1mm	PVC-1,5mm
300x150	3172.19PL	
400x200		3174.19PL



**Haaks - Fotolum - RV  
En drapeau - Photolum - RV**

	PVC
300x150	3062.19

**Alu anod.  
Alu anod.**

	Plat	Prof.
250x125	311C.19	31PC.19
300x150	3112.19	31P2.19

	PP	VIN.	PP-R/V
200x100	3121.20	3131.20	31J1.20
297x105	3128.20	3138.20	
300x150	3122.20	3132.20	31J2.20
400x200	3124.20	3134.20	

**Fotolum  
Photolum**

	PVC	VIN
200x100	3027.20	
300x150	3021.20	3031.20
400x200	3022.20	3032.20



**Alu anod.  
Alu anod.**

	Plat	Prof.
250x125	311C.20	31PC.20
300x150	3112.20	31P2.20

	PP	VIN.
200x100	3121.21	3131.21
297x105	3128.21	3138.21
300x150	3122.21	3132.21
400x200	3124.21	3134.21

**Fotolum  
Photolum**

	PVC	VIN
200x100	3027.21	
300x150	3021.21	3031.21
400x200	3022.21	3032.21

**Haaks - RV  
En drapeau - RV**

	PVC-1mm
300x150	3172.21



**Alu anod.  
Alu anod.**

	Plat	Prof.
250x125	311C.21	31PC.21
300x150	3112.21	31P2.21

	PP	VIN.	Spiegelbeeld VIN VIN Image réfléchie	PP-R/V	FOREX 5mm	FOREX R/V-5mm
50x50		313C.05				
100x100	3120.05	3130.05				
150x150	3121.05	3131.05				
200x200	3122.05	3132.05	31M2.05	31J1.05 31J2.05		
250x250	3123.05	3133.05				
300x300	3124.05	3134.05				
400x400	3125.05	3135.05				31GA.05
500x500	3126.05	3136.05				31G4.05
600x600	3127.05					31G5.05
700x700						31G6.05 31G7.05



**Fotolum  
Photolum**

	PVC	VIN
100x100	3020.05	3030.05
150x150	3026.05	3036.05
200x200	3021.05	3031.05
300x300	3022.05	
400x400	3025.05	3035.05

**Panoram.  
Panoram.**

	PVC-1mm	PVC-1,5mm
300x150	3124.71	
400x200	3125.71	
600x300		312F.71

**Panoram. - Fotolum  
Panoram. - Photolum**

	PVC
300x150	3023.05
400x200	3024.05

**Haaks - RV  
En drapeau - RV**

	PVC-1mm	PVC-1,5mm
100x100	3175.05	
150x150	3171.05	
200x200	3172.05	
250x250		3173.05
300x300		3174.05

# REDDING & EVACUATIE

# EVACUATION & SAUVETAGE



Haaks - Fotolum - R/V  
En drapeau - Photolum - R/V

	PVC
150x150	3071.05
200x200	3072.05



Alu anod. - Fotolum  
Alu anod. - Photolum

	Plat	Plat R/V	Haaks Drap. R/V	Prof.	Prof. Haaks Drap. R/V	Prof. Hang. Susp. R/V
150x150	3A1A.05	3A1S.05	3A11.05	3APA.05	3AP1.05	3APU.05



Plexi 6mm - Fotolum - Bevestigingen inbegr.  
Plexi 6mm - Photolum - Fixations incl.

	Muur/Mur	Zijw. R. Lat. R.	Zijw. R/V Lat. R/V	Plaf. R.	Plaf. R/V
150x150	51A1.03	55A1.03	52A1.03	53A1.03	54A1.03
200x200	51A2.03	55A2.03	52A2.03	53A2.03	54A2.03



Haaks - R/V  
En drapeau - R/V

	PVC-1mm	PVC-1,5mm
150x150	3171.25	
200x200	3172.25	
250x250		3173.25



Alu anod.  
Alu anod. Haaks Drap. R/V

125x125	311H.25
---------	---------



Alu anod. Alu anod.	Plat	Plat R/V	Haaks Drap. R/V	Prof.	Prof. Haaks Drap. R/V	Prof. Hang. Susp. R/V
125x125	311B.05	311S.05	311H.05	31PB.05	31PH.05	31PS.05
150x150	311A.05	311U.05	311I.05	31PA.05	31P1.05	31PU.05



Plexi 6mm - Bevestigingen inbegr.  
Plexi 6mm - Fixations incl.

	Muur/Mur	Zijw. R. Lat. R.	Zijw. R/V Lat. R/V	Plaf. R.	Plaf. R/V
150x150	5141.03	5541.03	5241.03	5341.03	5441.03
200x200	5142.03	5542.03	5242.03	5342.03	5442.03



Haaks - R/V  
En drapeau - R/V

	PVC-1mm
150x150	3171.24
200x200	3172.24



Alu anod.  
Alu anod.

	Haaks Drap. R/V
125x125	311H.24



	PP	VIN.
100x100	3120.47	
150x150	3121.47	3131.47
200x200	3122.47	3132.47
250x250	3123.47	3133.47
300x300	3124.47	
400x400		3135.47



Fotolum Photolum	PVC	VIN
100x100	3020.47	
150x150	3026.47	3036.47
200x200	3021.47	3031.47



	PP	VIN.
150x150	3121.48	3131.48
200x200	3122.48	3132.48



Fotolum Photolum	PVC	VIN
100x100	3020.46	
150x150	3026.46	3036.46
200x200	3021.46	3031.46



	PP	VIN.
150x150	3121.49	3131.49
200x200	3122.49	3132.49



Fotolum Photolum	PVC	VIN
150x150	3026.49	3036.49
200x200	3021.49	3031.49



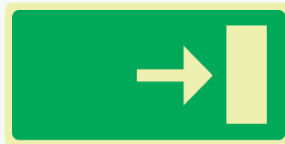

Fotolum  
Photolum



Fotolum  
Photolum

PP	VIN.	PVC	VIN.	PP	VIN.	PVC	VIN
200x100	3121.03	3131.03	3037.03	300x150	3122.89	3021.89	3031.89
300x150	3122.03	3132.03	3021.03	400x200	3124.F7		
400x200	3124.03	3134.03	3022.03				
600x300	312E.03						



Fotolum  
Photolum

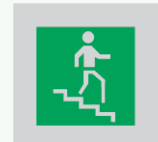

Alu anod.  
Alu anod.

PP	VIN.	PP	VIN.	PVC	Plat	Prof.	
300x150	3122.65	3132.65	100x100	3120.73	3130.73	150x150	3026.73
			150x150	3121.73	3131.73	125x125	311B.73
			200x200	3122.73		150x150	311A.73
			250x250	3123.73	3133.73		31PB.73



Fotolum  
Photolum

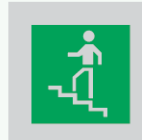

Alu anod.  
Alu anod.



PP	VIN.	PVC	Plat	Prof.	PP	VIN.
100x100	3120.74	3130.74	125x125	311B.74	31PB.74	250x80
150x150	3121.74	3131.74	150x150	311A.74	31PA.74	400x200
200x200	3122.74					3123.29
250x250	3123.74	3133.74				3133.29



Fotolum  
Photolum

PVC	VIN
150x75	3030.29
250x80	3026.29



Fotolum  
Photolum



Fotolum  
Photolum

PP	VIN.	PVC	VIN	PP	VIN.	PVC	VIN
300x150	3122.H8	3021.H8	3031.H8	300x150	3122.J0	3021.J0	3031.J0



Alle picto's kunnen, op aanvraag, met BARCODE worden geleverd, afzonderlijk (Ref.: BARCO1) of gekleefd (Ref.: BARCO2).

Tous les pictos peuvent, sur demande, être livrés à CODE-BARRES séparément (Ref.: BARCO1) ou collés (Ref.: BARCO2).

# REDDING & EVACUATIE



	PP	VIN.	PP-R/V	FOREX 5mm	FOREX R/V-5mm
100x200	3121.04	3131.04	31J1.04		
150x300	3122.04	3132.04	31J2.04		
200x400	3124.04	3134.04			31G1.04
250x500	3125.04			31E2.04	31G2.04
300x600	312E.04			31E3.04	31G3.04
400x800				31E8.04	31G8.04
500x1000				31E9.04	31G9.04



Alu anod.  
Alu anod.

	Plat	Plat R/V	Haaks Drap.R/V	Prof.	Prof. Haaks Drap.R/V	Prof. Hang. Susp.R/V
125x250	311C.04	311T.04	311J.04	31PC.04	31PJ.04	31PT.04
150x300	3112.04	311W.04	311K.04	31P2.04	31PK.04	31PW.04



Plexi 6mm - Bevestigingen inbegr.  
Plexi 6mm - Fixations incl.

	Muur Mur	Zijw.R/V Lat.R/V	Plat.R.	Plat.R/V
150x300	5143.04	5243.04	5343.04	5443.04

# EVACUATION & SAUVETAGE



Haaks - R/V  
En drapeau - R/V

	PVC-1mm
150x300	3172.04

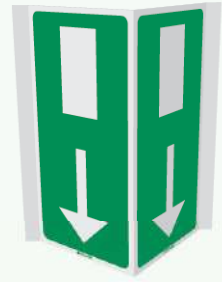

Panoram.  
Panoram.

	PVC-1mm
300x300	3125.72



Fotolum  
Photolum

	PVC	VIN
100x200	3027.04	3037.04
150x300	3021.04	3031.04
200x400	3022.04	3032.04



Panoram. - Fotolum  
Panoram. - Photolum

	PVC
300x300	3024.72



Alu anod. - Fotolum  
Alu anod. - Photolum

	Plat	Plat R/V	Haaks Drap.R/V	Prof.	Prof. Haaks Drap.R/V	Prof. Hang. Susp.R/V
150x300	3A12.04	3A1W.04	3A1K.04	3AP2.04	3APK.04	3APW.04



Plexi 6mm - Fotolum - Bevestigingen inbegr.  
Plexi 6mm - Photolum - Fixations incl.

	Muur Mur	Zijw.R/V Lat.R/V	Plat.R.	Plat.R/V
150x300	51A3.04	52A3.04	53A3.04	54A3.04

## NOODUITGANG

	PP	VIN.
250x90	3121.15	3131.15
310x120	3122.15	3132.15
400x150	3123.15	3133.15
500x150	3124.15	3134.15

## NOODUITGANG

Fotolum Photolum		
	PVC	VIN
250x90	3027.15	
310x120	3021.15	3031.15
500x150	3024.15	

## Nooduitgang vrijhouden

	PP	VIN.
250x90	3121.89	
500x200	3124.89	3134.89

## Nooduitgang vrijlaten a.u.b.

	PP	VIN.
250x90	3121.53	3131.53

## Nooduitgang vrijlaten a.u.b.

Fotolum Photolum		
	PVC	VIN
250x90	3026.53	3036.53

## Vluchtweg vrijlaten a.u.b.

	PP	VIN.
250x90	3121.67	3131.67

## UITGANG

	PP	VIN.
300x120	3122.14	3132.14
400x150	3123.14	3133.14

## UITGANG

Fotolum Photolum		
	PVC	VIN
310x120	3021.14	3031.14
400x150	3024.14	

## UIT

	PP	VIN.
300x150	3122.06	3132.06
400x200	3124.06	3134.06

## UIT

Fotolum Photolum		
	PVC	VIN
300x150	3021.06	3031.06

## TREKKEN

	PP	VIN.
90x40	3121.51	3131.51

## TREKKEN

Fotolum Photolum		PVC
90x40		3020.J2

## DUWEN

	PP	VIN.
90x40	3121.52	3131.52

## DUWEN

Fotolum Photolum		PVC
90x40		3020.J1



	PP	VIN.
150x200	3122.98	3132.98



	PP	VIN.
150x200	3122.BK	3132.BK



	PP	VIN.	VIN. Spgl
150x200	3122.A1	3132.A1	31A2.A1



	PP	VIN.	VIN. Spgl
150x200	3122.A2	3132.A2	31A2.A2

## SORTIE

	PP	VIN.
297x105	3128.16	3138.16
400x150	3123.16	3133.16

## SORTIE

Fotolum Photolum		
	PVC	
310x120	3021.42	
400x150	3024.42	

## SORTIE DE SECOURS

	PP	VIN.
297x105	3128.17	3138.17
310x120	3122.17	3132.17
500x150	3124.17	3134.17

## SORTIE DE SECOURS

Fotolum Photolum		PVC
310x120		3021.43
500x150		3024.43

## Sortie de secours laissez libre s.v.p.

	PP	VIN.
250x90	3121.68	3131.68

## Sortie de secours laissez libre s.v.p.

Fotolum Photolum		
	PVC	VIN
250x90	3026.68	3036.68

## SORTIE →

	PP	VIN.
297x105	3128.42	3138.42

## ← SORTIE

	PP	VIN.
297x105	3128.43	3138.43

# REDDING & EVACUATIE

# EVACUATION & SAUVETAGE



	PP	VIN.
297x105	3128.44	3138.44



	PP	VIN.
297x105	3128.45	3138.45



	PP	VIN.
90x40	3121.57	3131.57



	PP	VIN.
90x40	3121.58	3131.58



	PP	VIN.
400x150	3123.80	3133.80



	PP	VIN.
500x150	3124.81	3134.81



	PP	VIN.
280x70	3121.54	3131.54
525x150	3124.54	3134.54



	PP	VIN.
280x70	3121.55	3131.55



	PP	VIN.
400x150	3123.27	3133.27



	PP	VIN.
150x150	3121.A4	3131.A4



	PP	VIN.
150x150	3121.66	3131.66



	PP	VIN.
150x150	3121.79	3131.79
200x200	3122.79	3132.79



	PP	VIN.
150x150	3121.A7	3131.A7
200x200	3122.A7	3132.A7



	PP	VIN.
150x150	3121.77	3131.77
200x200	3122.77	3132.77
250x250		3133.77



Panoram.  
Panoram.

	PVC - 1mm
300x150	3124.77
400x200	3125.77



Haaks - RV  
En drapeau - RV

	PVC - 1mm
200x200	3172.77



	PP	VIN.
150x150	3121.N3	3131.N3
200x200	3122.N3	3132.N3
300x300	3123.N3	3133.N3



	PP	VIN.
150x150	3121.N4	3131.N4
200x200	3122.N4	3132.N4
300x300	3123.N4	3133.N4

ALLE PICTOGRAMMEN ZIJN OOK UITVOERBAAR OP ANDERE MATERIALEN  
TOUS LES PICTOGRAMMES SONT EGALEMENT POSSIBLES DANS D'AUTRES MATERIAUX



Dibond en Forex  
Dibond et Forex

EVACUATION & SAUVETAGE - DEA ILCOR



Fotolum  
Photolum

Panoram.  
Panoram.

Panoram. - Fotolum  
Panoram. - Photolum

50x50	PP	VIN.	Spiegelbeeld VIN		100x100	VIN	PVC-1mm		400x200	PVC
			Greenline	VIN Image réfléchie			PVC	VIN		
		313C.56	31UC.56			3030.24	200x100	312P.56		3024.24
100x100	3120.56	3130.56			200x200	3021.24	3031.24	300x150	3124.56	
150x150	3121.56	3131.56		31M1.56				400x200	3125.56	
200x200	3122.56	3132.56		31M2.56						
400x400	3125.H6									



Haaks - R/V  
En drapeau - R/V

Haaks - Fotolum - R/V  
En drapeau - Photolum - R/V

100x100	PVC-1mm		PVC	
	3175.56	150x150	3071.24	150x150
150x150	3171.56	200x200	3072.24	200x200
200x200	3172.56			



4D - REFL. - KLASSE I - 4 Zijden  
4D - REFL. - CLASSE I - 4 Faces

3D - REFL. - KLASSE I - 3 Zijden  
3D - REFL. - CLASSE I - 3 Faces

400x400	Alu PL		T.2000	
	31 X4.56	400x400	31 Y4.56	400x400

Bij de 3D en 4D borden zijn de beugels niet inbegrepen.  
Pour les panneaux 3D et 4D les brides ne sont pas incluses.



Fotolum  
Photolum

Panoram.  
Panoram.

Panoram. - Fotolum  
Panoram. - Photolum

150x150	PP	VIN.	Spiegelbeeld VIN		100x100	VIN	PVC-1mm		400x200	PVC
			Greenline	VIN Image réfléchie			PVC	VIN		
		3121.G3	31M1.G3			3030.G4	200x100	312P.G3		3024.G4
200x200	3122.G3	3132.G3	31M2.G3		200x200	3021.G4	3031.G4	300x150	3124.G3	
								400x200	3125.G3	



4D - REFL. - KLASSE I - 4 Zijden  
4D - REFL. - CLASSE I - 4 Faces

3D - REFL. - KLASSE I - 3 Zijden  
3D - REFL. - CLASSE I - 3 Faces

300x100	PP	VIN.	Spiegelbeeld VIN		300x100	VIN	Alu PL		400x400	T.2000
			Greenline	VIN Image réfléchie			Alu PL	T.2000		
		3128.A3	31A8.A3			3138.G5	300x100	31 X4.G3		31 Y4.G3

Bij de 3D en 4D borden zijn de beugels niet inbegrepen.  
Pour les panneaux 3D et 4D les brides ne sont pas incluses.

REDDING & EVACUATIE - AED ILCOR



Fotolum  
Photolum

Panoram.  
Panoram.

Panoram. - Fotolum  
Panoram. - Photolum

PP	VIN.	PVC	VIN	PVC-Imm	PVC
50x50	313C.F9	200x200	3021.28 3031.28	200x100	312P.F9
100x100	3120.F9 3130.F9			300x150	3124.F9P
150x150	3121.F9 3131.F9			400x200	3125.F9
200x200	3122.F9 3132.F9				
250x250	3123.F9 3133.F9				
300x300	3124.F9 3134.F9				



Haaks - R/V  
En drapeau - R/V

Haaks - Fotolum - R/V  
En drapeau - Photolum - R/V

4D - REFL. - KLASSE I - 4 Zijden  
4D - REFL. - CLASSE I - 4 Faces

3D - REFL. - KLASSE I - 3 Zijden  
3D - REFL. - CLASSE I - 3 Faces

PVC-Imm	PVC	Alu Pl.	T.2000
100x100	150x150	400x400	400x400
3175.F9	3071.28	31X4.Q9	31Y4.Q9
150x150	200x200		
3171.F9	3072.28		

Bij de 3D en 4D borden zijn de beugels niet inbegrepen.  
Pour les panneaux 3D et 4D les brides ne sont pas incluses.



PP	VIN.	PP	VIN.	VIN.	PP	VIN.	PP	VIN.	
300x100	3128.M0 3138.M0	100x300	3128.M2 3138.M2	300x100	3138.M3	100x150	3121.M3 3131.M3	200x150	3122.M4 3132.M4
						150x200	3122.M3 3132.M3		

## VOOR VEILIGHEIDSEHELM

## POUR CASQUE DE PROTECTION



Multigrip	Greenline	Multigrip	Greenline	Multigrip	Greenline
Ø50mm	313C.H0 31UC.H0	Ø50mm	313C.H1 31UC.H1	Ø50mm	313C.J1 31UC.J1



Multigrip	Greenline	Multigrip	Greenline	Multigrip	Greenline
Ø50mm	313C.H7 31UC.H7	Ø50mm	313C.H2 31UC.H2	Ø50mm	313C.H3 31UC.H3



Multigrip	Greenline	Multigrip	Greenline
40x40	313C.H4 31UC.H4	40x40	313C.H5 31UC.H5



Voorzie uw veiligheidshelmen van eigen tekst en/of logo.  
Prévoyez vos casques de protection de votre propre texte et/ou logo.



	PP 1,5mm		VIN.		VIN. REFL.	Alu anod.			Plexi 6mm muur / mur	Plexi 6mm zijw. / lat.	Fotol. / Photol. PVC VIN.	
	100x100mm	150x150mm	100x100mm	150x150mm	150x150mm	125x125mm	125x125mm RV	150x150mm	150x150mm	150x150mm	150x150mm	150x150mm
Blanco	3120.00	3121.00	3130.00	3131.00	31RA.00	311B.00		311A.00	5141.00	5241.00	3026.00	3036.00
-4	3120.98	3121.98	3130.98	3131.98	31RA.98	311B.98		311A.98	5141.A0	5241.A0	3026.98	3036.98
-3	3120.97	3121.97	3130.97	3131.97	31RA.97	311B.97		311A.97	5141.A1	5241.A1	3026.97	3036.97
-2	3120.41	3121.41	3130.41	3131.41	31RA.41	311B.41		311A.41	5141.17	5241.17	3026.41	3036.41
-1	3120.40	3121.40	3130.40	3131.40	31RA.40	311B.40		311A.40	5141.18	5241.18	3026.40	3036.40
0	3120.30	3121.30	3130.30	3131.30	31RA.30	311B.30		311A.30	5141.19	5241.19	3026.30	3036.30
+1	3120.31	3121.31	3130.31	3131.31	31RA.31	311B.31	311S.31	311A.31	5141.20	5241.20	3026.31	3036.31
+2	3120.32	3121.32	3130.32	3131.32	31RA.32	311B.32	311S.32	311A.32	5141.21	5241.21	3026.32	3036.32
+3	3120.33	3121.33	3130.33	3131.33	31RA.33	311B.33	311S.33	311A.33	5141.22	5241.22	3026.33	3036.33
+4	3120.34	3121.34	3130.34	3131.34	31RA.34	311B.34	311S.34	311A.34	5141.23	5241.23	3026.34	3036.34
+5	3120.35	3121.35	3130.35	3131.35	31RA.35	311B.35	311S.35	311A.35	5141.24	5241.24	3026.35	3036.35
+6	3120.36	3121.36	3130.36	3131.36	31RA.36	311B.36	311S.36	311A.36	5141.25	5241.25	3026.36	3036.36
+7	3120.37	3121.37	3130.37	3131.37	31RA.37	311B.37	311S.37	311A.37	5141.26	5241.26	3026.37	3036.37
+8	3120.38	3121.38	3130.38	3131.38	31RA.38	311B.38	311S.38	311A.38	5141.A2	5241.A2	3026.38	3036.38
+9	3120.39	3121.39	3130.39	3131.39	31RA.39	311B.39	311S.39	311A.39	5141.A3	5241.A3	3026.39	3036.39
+10	3120.90	3121.90	3130.90	3131.90	31RA.90	311B.90	311S.90	311A.90	5141.A4	5241.A4	3026.90	3036.90
+11	3120.91	3121.91	3130.91	3131.91	31RA.91	311B.91	311S.91	311A.91	5141.A5	5241.A5	3026.91	3036.91
+12	3120.92	3121.92	3130.92	3131.92	31RA.92	311B.92		311A.92	5141.A6	5241.A6	3026.92	3036.92
+13	3120.93	3121.93	3130.93	3131.93	31RA.93	311B.93		311A.93	5141.A7	5241.A7	3026.93	3036.93
+14	3120.94	3121.94	3130.94	3131.94	31RA.94	311B.94		311A.94	5141.A8	5241.A8	3026.94	3036.94
+15	3120.95	3121.95	3130.95	3131.95	31RA.95	311B.95		311A.95	5141.A9	5241.A9	3026.95	3036.95
+16	3120.96	3121.96	3130.96	3131.96	31RA.96	311B.96		311A.96	5141.B0	5241.B0	3026.96	3036.96
+17	3120.K0	3121.K0	3130.K0	3131.K0	31RA.K0	311B.K0		311A.K0	5141.B1	5241.B1	3026.K0	3036.K0
+18	3120.K1	3121.K1	3130.K1	3131.K1	31RA.K1	311B.K1		311A.K1	5141.B2	5241.B2	3026.K1	3036.K1

### 3D-LOOK

### LOOK - en 3D

voor ALU-PLAT

pour ALU-PLAT

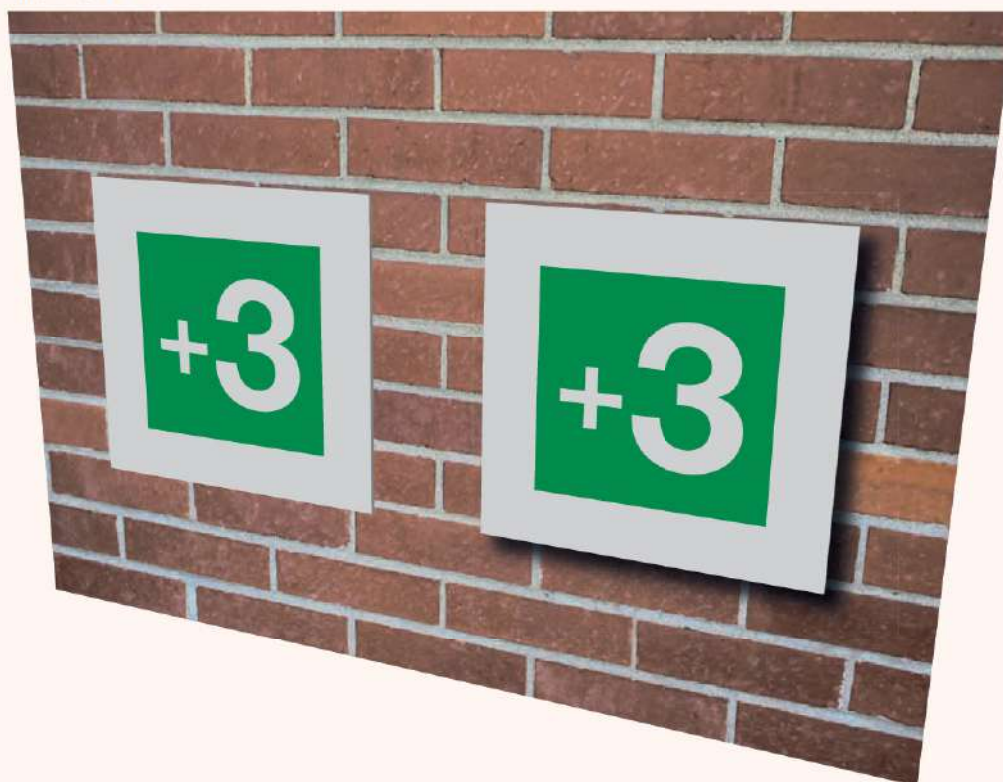

Voor formaten Pour formats	Afm. blok Dim. bloc	
125x125	(90x90)	B94101
150x150	(115x115)	B94201
250x125	(215x90)	B94301
300x150	(265x115)	B94401

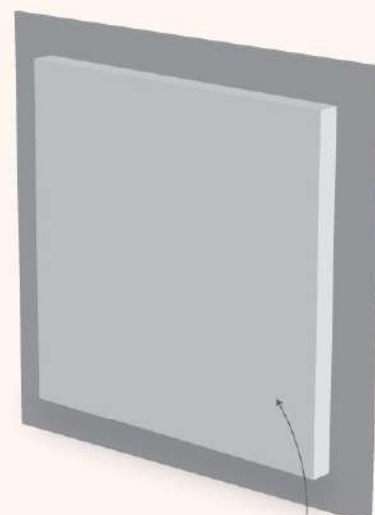

Achterkant  
Verso

Blok in Forex van 8mm met dubbelzijdige kleeftaag.  
Bloc en Forex de 8mm à feuille adhésive double face.

# FOTOLUMINESCERENDE MARKERING

# MARQUAGE PHOTOLUMINESCENT

## Vormen

## Formes

Vin.	Vin.	Vin.	Vin.	Vin.	PVC 1mm
per paar / par paire	per paar / par paire				zelfklevend / autocollante
300mm SG080	200mm SG082	75mm SG081	12 per vel / par feuille 64mm SG050A	12 per vel / par feuille 25mm SG060 per stuk / par pièce 50mm SG083 per stuk / par pièce 64mm SG050	50mm SG065

## Kleefbanden

## Rubans autocollants

Rol van 10m

Rouleau de 10m



20mm	SG030				
25mm	SG035				
40mm	SG031			SG042	SG043
50mm	SG036	SG033B	SG133		
75mm	SG037				
80mm	SG032			SG040	SG041
100mm	SG038				



Antislip fotoluminescerend op blz. 279  
Antidérapant photoluminescent sur page 279

## Blanco materiaal

## Matériel vierge

		<b>PVC klasse C / Classe C</b> 200x200mm SG6001 300x200mm SG6002 600x400mm SG6003 700x300mm SG6004 900x400mm SG6005 297x210mm SG6007 420x297mm SG6008			
Achterplaat voor blussers, plannen...	Plaque de fond pour extincteurs, plans...		Fotolumplaat 1.1mm Plaque photolum 1.1mm	Fotolumplaat 1.2mm Plaque photolum 1.2mm	Fotolumfolie 0.64mm Feuille photolum 0.64mm
			PVC klasse C / Classe C	Alu (700 mcd)	Vin. Klasse C / Classe C
			1200x1000mm 945C.00	1000x600mm 945E.00	1000x1000mm 945D.00

## Trapsignalisatie

## Signalisation escalier

Niet-zelfklevend

Non-autocollante



		Aluminium	
1000x10mm	effen / plaine	700 mcd	SG010
1000x30mm	set links- en rechtslopend set vers la gauche et la droite	300 mcd	SG020
1000x50mm	set links- en rechtslopend set vers la gauche et la droite	300 mcd	SG022



Aluminium (450 mcd)					
1000x60x22mm	1000x35mm	1000x35x14mm	1000x30x30mm	1000x33x33mm	1000x33x33mm
SG073	SG074	SG075	SG076	SG077	SG078



Trapneus antislip  
Nez de marche antidérapant



Trapneus antislip  
Nez de marche antidérapant

Rubber / caoutchouc	Aluminium
1000mm	1000x68x34mm
SG070	SG071

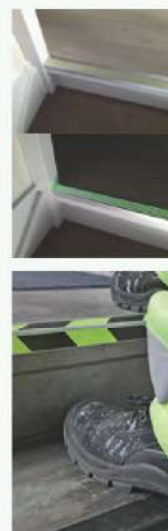

- MS polymeer Wit
- Lijmen en monteren
- 310 ml
- Uniek hechtingsvermogen
- Voor binnen en buiten
- Op natte en droge ondergrond
- Hecht op bijna alle ondergronden
- Hoge UV- en schimmelbestendigheid
- Polymère MS blanc
- Collier et monter
- 310 ml
- Adhérence unique
- Pour l'intérieur et l'extérieur
- Sur des surfaces mouillées et sèches
- Adhère sur la plupart des surfaces
- Haute résistance aux UV et à la moisissure

Wit  
Blanc

Verhoogde kleefkracht / Adhésion supérieure: TEC7

## Evacuatie

## Evacuation

Aluminium fotoluminescerend (300+mcd)

Aluminium photoluminescent (300+mcd)



150x150	3A1D.Q0	3A1D.75	3A1D.76	3A1D.08	3A1D.59
200x200	3A1E.Q0	3A1E.75	3A1E.76	3A1E.08	3A1E.59



300x150	3A1F.P1	3A1F.P3	3A1F.P4	3A1F.P7	3A1F.P8
400x200	3A1G.P1	3A1G.P3	3A1G.P4	3A1G.P7	3A1G.P8



300x150	3A1F.P2	3A1F.P5	3A1F.P6	3A1F.P9	3A1F.Q1
400x200	3A1G.P2	3A1G.P5	3A1G.P6	3A1G.P9	3A1G.Q1

## Niveau aanduiding

## Indication niveau

Aluminium fotoluminescerend (300+mcd)

Aluminium photoluminescent (300+mcd)



150x150	3A1D.41	3A1D.40	3A1D.30	3A1D.31	3A1D.32	3A1D.33	3A1D.34	3A1D.35	3A1D.36	3A1D.37	3A1D.38	3A1D.39
200x200	3A1E.41	3A1E.40	3A1E.30	3A1E.31	3A1E.32	3A1E.33	3A1E.34	3A1E.35	3A1E.36	3A1E.37	3A1E.38	3A1E.39

## Brandbestrijding

## Protection incendie

Aluminium fotoluminescerend (300+mcd)

Aluminium photoluminescent (300+mcd)



150x150	301D.26	301D.27	301D.30
200x200	301E.26	301E.27	301E.30

## Deurklink pictogrammen

## Pictogrammes poignées de porte

Aluminium fotoluminescerend (300+mcd) - zelfklevend

Aluminium photoluminescent (300+mcd) - auto-adhésif



100x248	SG61.01	SG61.02
---------	---------	---------

## Vloer- en plintpictogrammen

## Pictogrammes sol et plinthe

Aluminium fotoluminescerend (700mcd) - zelfklevend

Aluminium photoluminescent (700mcd) - auto-adhésif



100x50	3A10.PV	3A10.P2	3A10.P1
--------	---------	---------	---------



### AESTETICA LED

- IP40
- Autonomie 1h
- 292x102x36,8mm
- Picto : 212x80mm



### FORMULA LED

- IP65
- Autonomie 1h
- 354x152x48,5mm
- Picto : 320x120 mm



### STEP LED

- IP42
- Autonomie 1h
- 337x156x53mm
- Picto rigide: 300x150mm
- Plexi: 320x155mm

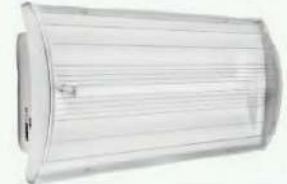

### STEP 2 LED

- IP42
- Autonomie 1h
- 368x170x80mm
- Clic-in picto : 355x130mm
- Plexi : 365x155mm

8w		11w	8w		11w	4.2w		5.2w	6w	
Permanent		B16223	Permanent	B19204	B19208	Permanent	B10023	B10223	Permanent	B8033
Niet/Non permanent	B16221		Niet/Non permanent	B19202	B19206					



- IP20
- Autonomie ca 3h
- 310x230mm



Inbouwframe voor EL115  
Système d'encastrement pour EL115



Muurbeugel voor haakse bevestiging EL115  
Support pour fixation EL115 en drapeau

2w					
EL115		EL115IF		EL115MB	



- IP20
- Autonomie ca 3h
- 345x200x65mm



- IP20
- Autonomie ca 3h
- 300x185x45mm



- IP20
- Autonomie ca 3h
- 336x200x76mm

2w		2w		2w	
EL123		EL124		EL117	



- IP20
- Autonomie ca 3h
- Antipaniekspot
- Spot anti-panique

2w

EL125



- IP65
- Autonomie ca 3h
- 350x102x72mm

3w

EL141



- IP65
- Autonomie ca 3h
- 352x117x60mm
- Picto : 300x115mm

8w

EL145



Sierring voor EL125 - Grijs  
Fixation décorative pour EL125 - Gris

EL125GR



Opzetstuk inclusief pictogrammen R/V - voor  
plafondbevestiging EL141  
Accessoire avec pictogrammes R/V - pour  
fixation EL141 au plafond

EL141CO



Opzetstuk inclusief pictogrammen R/V  
voor plafondbevestiging EL145  
Accessoire avec pictogrammes R/V  
pour fixation EL145 au plafond

EL145CO



Sierring voor EL125 - Zwart  
Fixation décorative pour EL125 - Noir

EL125ZR



RVS korf ter bescherming van EL141  
Panier de protection en inox pour EL141

EL141KORF



Inbouwframe voor EL145  
Système d'encastrement pour EL145

EL145IF



LUNGALARGALUCE

- IP43
- Autonomie 1h
- 137x137x32mm

3w

B19321



LUNGALARGALUCE

- IP43
- Autonomie 1h
- 120x28mm

3w

B19331



Verscheidene versies zijn ook beschikbaar  
met een haakse of hangende picto.

Différents modèles sont aussi disponibles  
avec une version en drapeau ou pendent.

Niet/Non permanent

Niet/Non permanent



**AESTETICA**

- IP40
- Autonomie 1h
- 336,4x134,6x46,8mm
- Picto : 290x105 mm



**STEP**

- IP42
- Autonomie 1h
- 337x156x53mm
- Picto rigide : 300x150mm
- Plexi : 320x150mm



**FORMULA**

- IP65
- Autonomie 1h
- 354x152x48,5mm
- Picto : 320x120mm

8w		8w		8w	11w
Permanent	B12504	Permanent	STEP	Permanent	B19105
Niet/Non permanent	B12512			Niet/Non permanent	B19104
				Permanent+ Niet/Non permanent	B19106



Een andere lamp gezien of op zoek naar iets specifiek voor een project? Contacteer ons.  
Avez-vous vu une autre lampe ou à la recherche de quelque chose de spécial pour un projet? Contactez nous.

## Pictogrammen noodverlichting

## Pictogrammes éclairage de secours

Opaal wit vinyl

Vinyle blanc opale



VIN.

290x105 3139.P1B 3139.P2B 3139.P3B 3139.P4B 3139.P5B 3139.P6B



VIN.

290x105 3139.01B 3139.02B 3139.60B 3139.61B 3139.62B 3139.63B



VIN.

290x80 3139.03B 3139.14B 3139.15B 3139.16B 3139.17B 3139.05A  
 290x105 3139.03B 3139.14B 3139.15B 3139.16B 3139.17B 3139.05B  
 345x116 3139.03C  
 370x132 3139.14E 3139.15E 3139.16E 3139.17E 3139.05D

# NOODVERLICHTING

## Draagbare noodlampen



- IP40
- Autonomie : 9,5-85h
- 127x337x113mm
- Opladbaar / rechargeable
- Wordt geleverd met schouderriem  
Livré avec bandoulière

	Geel / Jaune
LED	B8380

**Beghelli**

SCOUT LED

# ÉCLAIRAGE DE SECOURS

## Lampes de secours portables

## ATEX Noodverlichting

## Éclairage de secours ATEX



- Explosie veilig / anti-déflagrant
- Niet permanent / non-permanent
- Hoge flux secours / flux secours haut: 540lm
- Bescherming / protection: IP66
- Lichtbron / lampes: 4 LED
- Autonomie: 1h
- 455x205xØ165mm

B25554



PLURALUCE ATEX IP65/IK09

B19370

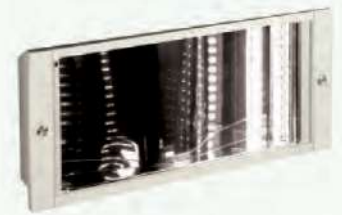

**Beghelli**

ACCIAIO LED

- IP66
- Autonomie 1h
- 391x174x59,5mm
- Picto : 212x80 mm

	24w
	B15030

# EVACUATIEHULP

## Vlucht ladder

# AIDE D'ÉVACUATION

## Échelle de secours



Lengte / Longueur	verdieping / étage*	
5mtr	1	J730
7mtr	2	J731
10mtr	3 - 4	J732
16mtr	5 - 6	J733
20mtr	6 - 7	J734

\*uitgaande van een verdiepingshoogte van 2,6 meter  
\*en supposant une hauteur de plancher de 2,6 mètres

Geschikt voor vensterbanken tot 38cm diep  
Convient aux appuis de fenêtre jusqu'à une largeur de 38 cm

Vlucht ladder - Draagcapaciteit 450kg  
Échelle de secours - Capacité 450kg

## Evacuatiealarm

## Alarme d'évacuation



J642

- Manueel alarm - Type A
- Binnen te gebruiken
- Déclencheur manuel - Type A
- Environnement intérieur
- IP40
- 93X93X59mm

Eenvoudige montage onder de deurklink of aan deuren met een paniekstang.  
 Uitschakeling alarm 95dB door systeemsleutel. Batterijgestuurd - Metalen behuizing.  
 Montage simple sous la poignée ou portes à barre.  
 Désactivation alarme 95dB par clé système. Alimentation par batterie - Boîtier métallique.



SI0101



SI0201



SI1101

	NL	FR	ENG / ANGL.
Deurklink zonder vooralarm	SI0101	SI0102	SI0103
Poignée de porte sans préalarme			
Deurklink met vooralarm	SI0201	SI0202	SI0203
Poignée de porte avec préalarme			
Montageplaat op glasdeur 17,5cm		SI0800	
Plaque de montage pour porte vitrée 17,5cm			
Montageplaat op brandvertragende deur		SI0900	
Plaque de montage pour porte antifeu			

	NL	FR	ENG / ANGL.
Paniekstang zonder vooralarm	SI1101	SI1102	SI1103
Barre antipanique sans préalarme			
Paniekstang met vooralarm	SI1201	SI1202	SI1203
Barre antipanique avec préalarme			
Montageplaat bij paniekstang, 30mm links		SI1800	
Plaque de montage pour barre antipanique, 30mm gauche			
Montageplaat bij paniekstang, 50mm links		SI1900	
Plaque de montage pour barre antipanique, 50mm gauche			



SI2301



SI2401

NL + ENG	
SI2301	Paniekstang met vooralarm Barre antipanique avec préalarme
SI2401	Push bar met vooralarm Push bar avec préalarme
SI2900	Reserve breekplaatjes rood (set 6 stuks) Plaques rouges auto-cassants de réserve (set de 6 pièces)
SI2800	Opbouwbeugel Bride à pression
SI2700	Reservesleutel Clé de rechange

## Deuralarm

## Alarme porte



SI3100

Deuralarm	SI3100
Alarme porte	
Infrarood relais	SI3900
Relais infrarouge	

Eenvoudige montage van een deuralarm aan ramen en deuren. - Alarm 105dB, flitslicht.  
 Uitschakeling alarm door systeemsleutel. - Voeding op elektriciteitsnet 220-230V.  
 Infrarood relais op afstand mogelijk (±30m)

Montage simple d'une alarme porte aux fenêtres et portes. - Alarme 105dB, lampe clignotante.  
 Désactivation alarme par clé système. - Alimentation sur circuit électricité 220-230V.  
 Relais infrarouge possible à distance (±30m)

# BRANDBESTRIJDING ISO 7010

# PROTECTION INCENDIE ISO 7010

PROTECTION INCENDIE - ISO 7010



PP	VIN.	Greenline	PP-R/V	Signicolor 1,5mm	FOREX 5mm	FOREX R/V-5mm	Haaks / En drapeau - R/V		Fotolum / Photolum		
							PVC-1mm	PVC-1,5mm	PVC		
100x100	3321.26	3331.26					100x100	3361.D0	100x100	3040.26	3030.26
150x150	332A.26	333A.26	33JA.26				125x125	3366.09	150x150	3046.26	3036.26
200x200	3322.26	3332.26	33U2.26	33J2.26	3312.26		150x150	3365.09	200x200	3044.26	3034.26
300x300	3323.26	3333.26				33G3.26	200x200	3329.09	400x400	3045.26	
400x400	3324.26	3334.26				33E4.26	250x250	3362.09			
500x500	3325.26	3335.26				33E5.26	300x300	3363.09			
600x600	3326.26	3336.26				33E6.26	400x400	3364.09			
700x700						33E7.26					



Panoram.		Panoram. - Fotolum / Photolum		Plafond - R/V		Plafond - Fotolum / Photolum - R/V		Haaks / En drapeau - Fotolum / Photolum - R/V	
PVC-1mm	PVC-1,5mm	PVC		PVC-1mm	PVC-1,5mm	PVC		PVC	
200x100	332C.62	300x150	3043.62	150x150	3365.09PL	150x150	3081.26PL	150x150	3081.26
300x150	3324.62	400x200	3045.62	200x200	3329.09PL			200x200	3082.26
400x200	3326.62			400x400	3364.09PL				
600x300	332F.62								



Plat		Plat - Fotolum / Photolum		Haaks / En drapeau - R/V		Haaks / En drapeau - Fotolum / Photolum - R/V	
Alu anod. - 1,5mm		Alu anod. - 1,5mm		Alu anod. - 1,5mm		Alu anod. - 1,5mm	
125x125	331B.26	150x150	301A.26	125x125	331H.26	150x150	3011.26
150x150	331A.26			150x150	3311.26		



Zwarte eindkappen / Finition noire		Zwarte eindkappen / Finition noire - Fotol. / Photol.		Zwarte eindkappen / Finition noire - R/V		Zwarte eindkappen / Finition noire - Fotol. / Photol. - R/V	
Alu anod. - 1,5mm		Alu anod. - 1,5mm		Alu anod. - 1,5mm		Alu anod. - 1,5mm	
125x125	33PB.26	150x150	30PA.26	125x125	33PH.26	150x150	30P1.26
150x150	33PA.26			150x150	33P1.26		



Zwarte eindkappen - Hangend Finition noire - Suspendu		Zwarte eindkappen - Hangend - Fotolum Finition noire - Suspendu - Photolum		Muur - Bevestigingen inbegr. Mur - Fixations incl.		Muur - Bevestigingen inbegr. - Fotolum Mur - Fixations incl. - Photolum	
Alu anod. - 1,5mm		Alu anod. - 1,5mm		Plexi 6mm		Plexi 6mm	
125x125	33PS.26	150x150	30PU.26	150x150	5141.47	150x150	51A1.47
150x150	33PU.26			200x200	5142.47	200x200	51A2.47



Zijwaarts - Bevestigingen inbegr. Latéral - Fixations incl.			Zijwaarts - Bevestigingen inbegr. - Fotolum Latéral - Fixations incl. - Photolum			Hangend - Bevestigingen inbegr. Suspendu - Fixations incl.			Hangend - Bevestigingen inbegr. - Fotolum Suspendu - Fixations incl. - Photolum		
Plexi 6mm	Recto	R/V	Plexi 6mm	Recto	R/V	Plexi 6mm	Recto	R/V	Plexi 6mm	Recto	R/V
150x150	5541.47	5241.47	150x150	55A1.47	52A1.47	150x150	5341.47	5441.47	150x150	53A1.47	54A1.47
200x200	5542.47	5242.47	200x200	55A2.47	52A2.47	200x200	5342.47	5442.47	200x200	53A2.47	54A2.47

BRANDBESTRIJDING - ISO 7010



	PP	VIN.	PP-R/V	Signicolor1,5mm	FOREX 5mm	FOREX R/V-5mm
100x100	3321.27	3331.27				
150x150	332A.27	333A.27	33JA.27			
200x200	3322.27	3332.27	33J2.27	3312.27		
300x300	3323.27	3333.27				33G3.27
400x400	3324.27	3334.27			33E4.27	33G4.27
500x500	3325.27	3335.27				
600x600	3326.27	3326.27			33E6.27	33G6.27
700x700					33E7.27	

Haaks / En drapeau - R/V			Fotolum / Photolum		
	PVC-1mm	PVC-1,5mm	PVC		
100x100	3361.08		100x100	3040.27	3030.27
150x150	3365.08		150x150	3046.27	3036.27
200x200	3329.08		200x200	3044.27	3034.27
250x250		3362.08	400x400	3045.27	
300x300		3363.08			
400x400		3364.08			



Panoram.		Panoram. - Fotolum / Photolum		Plafond - R/V		Plafond - Fotolum / Photolum - R/V		Haaks / En drapeau - Fotolum / Photolum - R/V		
	PVC-1mm	PVC-1,5mm	PVC		PVC-1mm		PVC		PVC	
200x100	332C.61		300x150	3043.K2	150x150	3365.08PL	150x150	3081.27PL	150x150	3081.27
300x150	3324.61		400x200	3045.K2			200x200	3082.27PL	200x200	3082.27
400x200	3326.61									
600x300		332F.61								



Plat			Plat - Fotolum / Photolum			Haaks / En drapeau - R/V		Haaks / En drapeau - Fotolum / Photolum - R/V	
Alu anod. - 1,5mm		Recto	R/V	Alu anod. - 1,5mm		Alu anod. - 1,5mm		Alu anod. - 1,5mm	
125x125		331B.27		150x150	301A.27	125x125	331H.27	150x150	3011.27
150x150		331A.27	331J.27			150x150	3311.27		



Zwarte eindkappen / Finition noire		Zwarte eindkappen / Finition noire - Fotol. / Photol.		Zwarte eindkappen / Finition noire - R/V		Zwarte eindkappen / Finition noire - Fotol. / Photol. - R/V	
Alu anod. - 1,5mm		Alu anod. - 1,5mm		Alu anod. - 1,5mm		Alu anod. - 1,5mm	
125x125		33PB.27		150x150	30PA.27	125x125	33PH.27
150x150		33PA.27		150x150		150x150	30P1.27



Zwarte eindkappen - Hangend Finition noire - Suspendu			Zwarte eindkappen - Hangend - Fotolum Finition noire - Suspendu - Photolum			Muur - Bevestigingen inbegr. Mur - Fixations incl.			Muur - Bevestigingen inbegr. - Fotolum Mur - Fixations incl. - Photolum		
Alu anod. - 1,5mm			Alu anod. - 1,5mm			Plexi 6mm			Plexi 6mm		
125x125		33PS.27	150x150		30PU.27	150x150		5141.48	150x150		51A1.48
150x150		33PU.27				200x200		5142.48	200x200		51A2.48



Zijwaarts - Bevestigingen inbegr. Latéral - Fixations incl.			Zijwaarts - Bevestigingen inbegr. - Fotolum Latéral - Fixations incl. - Photolum			Hangend - Bevestigingen inbegr. Suspendu - Fixations incl.			Hangend - Bevestigingen inbegr. - Fotolum Suspendu - Fixations incl. - Photolum			
Plexi 6mm		Recto	R/V	Plexi 6mm		Recto	R/V	Plexi 6mm		Recto	R/V	
150x150		5541.48	5241.48	150x150	55A1.48	52A1.48	150x150	5341.48	5441.48	150x150	53A1.48	54A1.48
200x200		5542.48	5242.48	200x200	55A2.48	52A2.48	200x200	5342.48	5442.48	200x200	53A2.48	54A2.48

# BRANDBESTRIJDING ISO 7010

# PROTECTION INCENDIE ISO 7010

PROTECTION INCENDIE - ISO 7010



PP	VIN.	Greenline	PP-R/V	Signicolor 1,5mm	FOREX 5mm	FOREX R/V-5mm	Haaks / En drapeau - R/V		Fotolum / Photolum	
							PVC-1mm	PVC-1,5mm	PVC	VIN
50x50	3330.30						100x100	3361.11	100x100	3040.63
100x100	3321.30	3331.30					150x150	3365.11	150x150	3046.63 3036.63
150x150	332A.30	333A.30					200x200	3329.11	200x200	3044.63 3034.63
200x200	3322.30	3332.30					300x300	3363.11		
300x300	3323.30	3333.30					400x400	3364.11		
400x400	3324.30	3334.30								
500x500	3325.30									
600x600	3326.30									



Panoram.		Panoram. - Fotolum / Photolum		Plafond - R/V		Plafond - Fotolum / Photolum - R/V		Haaks / En drapeau - Fotolum / Photolum - R/V	
PVC-1mm	PVC-1,5mm	PVC		PVC-1mm		PVC-1mm		PVC-1mm	
200x100	332C.63	300x150	3043.63	150x150	3365.11PL			150x150	3081.63
300x150	3324.63	400x200	3045.63					200x200	3082.63
400x200	3326.63								
600x300	332F.63								



Plat			Plat - Fotolum / Photolum			Haaks / En drapeau - R/V		Haaks / En drapeau - Fotolum / Photolum - R/V	
Alu anod. - 1,5mm	Recto	R/V	Alu anod. - 1,5mm		Alu anod. - 1,5mm		Alu anod. - 1,5mm		
125x125	331B.30		160x150	301A.30	125x125	331H.30	150x150	3011.30	
150x150	331A.30	331J.30			160x150	3311.30			
200x200	3312.30								



Zwarte eindkappen / Finition noire		Zwarte eindkappen / Finition noire - Fotol. / Photol.		Zwarte eindkappen / Finition noire - R/V		Zwarte eindkappen / Finition noire - Fotol. / Photol. - R/V	
Alu anod. - 1,5mm		Alu anod. - 1,5mm		Alu anod. - 1,5mm		Alu anod. - 1,5mm	
125x125	33PB.30	160x150	30PA.30	125x125	33PH.30	150x150	30P1.30
150x150	33PA.30			160x150	33P1.30		



Zwarte eindkappen - Hangend Finition noire - Suspendu			Zwarte eindkappen - Hangend - Fotolum Finition noire - Suspendu - Photolum			Muur - Bevestigingen inbegr. Mur - Fixations incl.			Muur - Bevestigingen inbegr. - Fotolum Mur - Fixations incl. - Photolum		
Alu anod. - 1,5mm			Alu anod. - 1,5mm			Plexi 6mm			Plexi 6mm		
125x125	33PS.30		150x150	30PU.30		150x150	5141.49	5441.49	150x150	51A1.49	54A1.49
150x150	33PU.30					200x200	5142.49	5442.49	200x200	51A2.49	54A2.49



Zijwaarts - Bevestigingen inbegr. Latéral - Fixations incl.			Zijwaarts - Bevestigingen inbegr. - Fotolum Latéral - Fixations incl. - Photolum			Hangend - Bevestigingen inbegr. Suspendu - Fixations incl.			Hangend - Bevestigingen inbegr. - Fotolum Suspendu - Fixations incl. - Photolum		
Plexi 6mm	Recto	R/V	Plexi 6mm	Recto	R/V	Plexi 6mm	Recto	R/V	Plexi 6mm	Recto	R/V
150x150	5541.49	5241.49	150x150	55A1.49	52A1.49	150x150	5341.49	5441.49	150x150	53A1.49	54A1.49
200x200	5542.49	5242.49	200x200	55A2.49	52A2.49	200x200	5342.49	5442.49	200x200	53A2.49	54A2.49

BRANDBESTRIJDING - ISO 7010

# BRANDBESTRIJDING ISO 7010

# PROTECTION INCENDIE ISO 7010



			Fotolum / Photolum		Haaks / En drapeau - R/V		Haaks / En drapeau Fotolum / Photolum - R/V		Panoram.		Panoram. Fotolum / Photolum	
PP	VIN.		PVC		PVC-1mm		PVC-1mm		PVC-1mm	PVC-1,5mm	PVC	
100x100	3321.29	3331.29	100x100	3040.B2	150x150	3365.101	3081.B2	3082.B2	200x100	332C.B2	3043.B2	
150x150	332A.29	333A.29	150x150	3046.B2	200x200	3329.10			300x150	3324.B2	3045.B2	
200x200	3322.29	3332.29	200x200	3044.B2					400x200	3326.B2		
300x300	3323.29	3333.29							600x300	332F.B2		



Plat		Haaks / En drapeau R/V	Zwarte eindkappen Finition noire	Zwarte eindkappen Finition noire - R/V	Zwarte eindkappen - Hangend Finition noire - Suspensu	Fotolum / Photolum	Plat	Haaks / En drapeau R/V	Zwarte eindkappen Finition noire	Zwarte eindkappen Finition noire - R/V	
Alu anod. - 1,5mm						Alu anod. - 1,5mm					
125x125	331B.10	331H.10	33PB.10	33PH.10	33PS.10	150x150	301A.10	3011.10	30PA.10	30P1.10	
150x150	331A.10	3311.10	33PA.10	33P1.10	33PU.10						



Muur - Bevestigingen inbegr. Mur - Fixations incl.		Zijwaarts - Bevestigingen inbegr. Latéral - Fixations incl.	Hangend - Bevestigingen inbegr. Suspensu - Fixations incl.		Fotolum Photolum	Muur - Bevestigingen inbegr. Mur - Fixations incl.		Zijwaarts - Bevestigingen inbegr. Latéral - Fixations incl.	Hangend - Bevestigingen inbegr. Suspensu - Fixations incl.	
Plexi 6mm					Plexi 6mm					
150x150	5141.61	5241.61	5441.61		150x150	51A1.61	52A1.61	54A1.61		



		Fotolum / Photolum		Panoram.		Haaks / En drapeau - R/V		Plat		Muur - Bevestigingen inbegr. Mur - Fixations incl.	
PP	VIN.	PVC	VIN.	PVC-1mm		PVC-1mm		Alu anod.		Plexi 6mm	
100x100	3321.M8	3331.M8	3040.M8	200x100	332C.M8	150x150	3365.M8	125x125	331B.M8	150x150	5141.H1
150x150	332A.M8	333A.M8	3046.M8	3036.M8	300x150	3324.M8	200x200	3329.M8	150x150	331A.M8	
200x200	3322.M8	3332.M8	3044.M8	3034.M8	400x200	3326.M8					
300x300	3323.M8	3333.M8									



Zijwaarts - Bevestigingen inbegr. Latéral - Fixations incl.		Hangend - Bevestigingen inbegr. Suspensu - Fixations incl.		Fotolum / Photolum		Panoram.		
Plexi 6mm				PP		VIN.		
				PVC		PVC-1mm		
150x150	5241.H1	5441.H1	150x150	332A.M5	333A.M5	3046.M5	400x200	3326.M5
			200x200	3322.M5	3332.M5	3044.M5		



			Fotolum / Photolum					Fotolum / Photolum				
PP	VIN.		PVC		PP	VIN.	PP	VIN.	PVC		PP	VIN.
100x100	3321.28	3331.28	100x100	3040.E2	100x100	3321.31	3331.31	100x100	3040.E3	100x100	3321.44	3331.44
200x200	3322.28	3332.28	150x150	3046.E2	150x150	3322.31	3332.31	150x150	3046.E3	150x150	3322.44	3332.44
300x300	3323.28	3333.28	200x200	3044.E2	200x200	3323.31	3333.31	200x200	3044.E3	200x200	3323.44	3333.44
400x400	3324.28	3334.28			300x300	3323.31	3333.31					

# BRANDBESTRIJDING ISO 7010

# PROTECTION INCENDIE ISO 7010



PP	VIN.
150x150	332A.M4 333A.M4
200x200	3322.M4 3332.M4

Fotolum / Photolum	
PVC	
150x150	3044.M4
200x200	3044.M4

PP	VIN.
150x150	332A.M2 333A.M2
200x200	3322.M2 3332.M2

Fotolum / Photolum	
PVC	
150x150	3044.M2
200x200	3044.M2



PP	VIN.
150x150	332A.M3 333A.M3
200x200	3322.M3 3332.M3

Fotolum / Photolum	
PVC	
150x150	3044.M3
200x200	3044.M3

PP	VIN.
150x150	332A.M0 333A.M0
200x200	3322.M0 3332.M0

Fotolum / Photolum	
PVC	
150x150	3044.M0
200x200	3044.M0



PP	VIN.
150x150	332A.M1 333A.M1
200x200	3322.M1 3332.M1

Fotolum / Photolum	
PVC	
150x150	3044.M1
200x200	3044.M1

PP	VIN.
150x150	332A.M6 333A.M6
200x200	3322.M6 3332.M6

Fotolum / Photolum	
PVC	
150x150	3044.M6
200x200	3044.M6



PP	VIN.
150x150	332A.M7 333A.M7
200x200	3322.M7 3332.M7

Fotolum / Photolum	
PVC	
150x150	3044.M7
200x200	3044.M7

PP	VIN.
150x150	332A.N4 333A.N4
200x200	3322.N4 3332.N4
400x400	3334.N4



## Combipictogrammen

## Pictogrammes combinés



PP	
100x200	3391.F0
150x300	3392.F0
200x400	3393.F0

Fotolum / Photolum	
PVC	
150x300	3092.F0
200x400	3093.F0

Plexi 6mm - Bevestigingen inbegr. Plexi 6mm - Fixations incl.	
Muur/Mur	Zijw./Lat. R/V
150x300	5143.F0 5243.F0

Plexi 6mm - Fotolum - Bevestigingen inbegr. Plexi 6mm - Photolum - Fixations incl.	
Muur/Mur	Zijw./Lat. R/V
150x300	51A3.F0 52A3.F0

# BRANDBESTRIJDING ISO 7010

# PROTECTION INCENDIE ISO 7010

## Combipictogrammen

## Pictogrammes combinés



Panoram. Panoram.		Panoram. - Fotolum Panoram. - Photolum		Haaks - R/V En drapeau - R/V		Haaks - Fotolum - R/V En drapeau - Photolum - R/V	
PVC-1mm	PVC-1,5mm	PVC		PVC-1mm	PVC-1,5mm	PVC	
200x200	3351.F0	300x300	3052.F0	100x200	3371.F0	150x300	3072.F0
300x300	3352.F0	400x400	3053.F0	150x300	3372.F0	200x400	3073.F0
400x400	3353.F0			200x400	3373.F0		



PP		Fotolum / Photolum		Plexi 6mm - Bevestigingen inbegr. Plexi 6mm - Fixations incl.		Plexi 6mm - Fotolum - Bevestigingen inbegr. Plexi 6mm - Photolum - Fixations incl.	
PP		PVC		Muur/Mur	Zijw. / Lat. R/V	Muur/Mur	Zijw. / Lat. R/V
100x200	3391.F3	150x300	3092.F3	150x300	5143.F3 5243.F3	150x300	51A3.F3 52A3.F3
150x300	3392.F3	200x400	3093.F3				
200x400	3393.F3						



Panoram. Panoram.		Panoram. - Fotolum Panoram. - Photolum		Haaks - R/V En drapeau - R/V		Haaks - Fotolum - R/V En drapeau - Photolum - R/V	
PVC-1mm	PVC-1,5mm	PVC		PVC-1mm	PVC-1,5mm	PVC	
200x200	3351.F3	300x300	3052.F3	100x200	3371.F3	150x300	3072.F3
300x300	3352.F3	400x400	3053.F3	150x300	3372.F3	200x400	3073.F3
400x400	3353.F3			200x400	3373.F3		



PP		Fotolum / Photolum		Plexi 6mm - Bevestigingen inbegr. Plexi 6mm - Fixations incl.		Plexi 6mm - Fotolum - Bevestigingen inbegr. Plexi 6mm - Photolum - Fixations incl.	
PP		PVC		Muur/Mur	Zijw. / Lat. R/V	Muur/Mur	Zijw. / Lat. R/V
100x200	3391.F4	150x300	3092.F4	150x300	5143.F4 5243.F4	150x300	51A3.F4 52A3.F4
150x300	3392.F4	200x400	3093.F4				
200x400	3393.F4						

PROTECTION INCENDIE - ISO 7010

BRANDBESTRIJDING - ISO 7010

# BRANDBESTRIJDING ISO 7010

# PROTECTION INCENDIE ISO 7010

## Combipictogrammen

## Pictogrammes combinés



Panoram. Panoram.		Panoram. - Fotolum Panoram. - Photolum		Haaks - R/V En drapeau - R/V		Haaks - Fotolum - R/V En drapeau - Photolum - R/V	
PVC-1mm	PVC-1,5mm	PVC		PVC-1mm	PVC-1,5mm	PVC	
200x200	3351.F4	300x300	3052.F4	100x200	3371.F4	150x300	3072.F4
300x300	3352.F4	400x400	3053.F4	150x300	3372.F4	200x400	3073.F4
400x400	3353.F4			200x400	3373.F4		



Panoram. Panoram.		Panoram. - Fotolum Panoram. - Photolum		Haaks - R/V En drapeau - R/V		Haaks - Fotolum - R/V En drapeau - Photolum - R/V	
PVC-1mm	PVC-1,5mm	PVC		PVC-1mm	PVC-1,5mm	PVC	
200x300	3354.F2	200x300	3054.F2	100x300	3376.F2	200x600	3078.F2
300x450	3356.F2	300x450	3056.F2	150x450	3377.F2		
400x600	3357.F2	400x600	3057.F2	200x600	3378.F2		



PP		Fotolum / Photolum		Plexi 6mm - Bevestigingen inbegr. Plexi 6mm - Fixations incl.		Plexi 6mm - Fotolum - Bevestigingen inbegr. Plexi 6mm - Photolum - Fixations incl.	
PP		PVC		Muur/Mur Zijw. / Lat. R/V		Muur/Mur Zijw. / Lat. R/V	
100x300	3396.F2	150x450	3097.F2	150x450	5144.F2 5244.F2	150x450	51A4.F2 52A4.F2
150x450	3397.F2	200x600	3098.F2				
200x600	3398.F2						



PP		Fotolum / Photolum		Muur - Bevestigingen inbegr. Mur - Fixations incl.		Muur - Bevestigingen inbegr. - Fotolum Mur - Fixations incl. - Photolum	
PP		PVC		Plexi 6mm		Plexi 6mm	
400x200	3393.F5	400x200	3093.F5	400x200	5145.F5	400x200	51A5.F5

# BRANDBESTRIJDING CLASSIFICATIE

# PROTECTION INCENDIE CLASSIFICATION



PP					
148x210	3382.J5	3382.J6	3382.J0	3382.J1	3382.J2
200x290	3343.J5	3343.J6	3343.J0	3343.J1	3343.J2



PP					
148x210	3382.J7	3382.J8	3382.J9	3382.J3	3382.J4
200x290	3343.J7	3343.J8	3343.J9	3343.J3	3343.J4



PP					
148x210	3382.02	3382.13	3382.11	3382.03	3382.01
200x290	3343.02	3343.13	3343.11	3343.03	3343.01



VIN-DIN - Fotolum / Photolum				
110x30	303C.H0	303C.H1	303C.H2	303C.H3



PP	80x200	80x200	80x200	80x200	80x200	80x200
NL	3341.21	3341.22	3341.23	3341.24	3341.20	3341.96
FR	3341.31	3341.32	3341.33	3341.34	3341.30	3341.97

# BRANDBESTRIJDING

# PROTECTION INCENDIE



	PP	VIN.	Greenline	PP-R/V	Signicolor 1,5mm	FOREX 5mm	FOREX R/V-5mm
100x100	3321.25	3331.25					
150x150	332A.25	333A.25		33JA.25			
200x200	3322.25	3332.25	33U2.25	33J2.25	3312.25		
300x300	3323.25	3333.25					33G3.25
400x400	3324.25	3334.25				33E4.25	33G4.25
500x500	3325.25	3335.25				33E5.25	33G5.25
600x600	3326.25	3336.25				33E6.25	33G6.25
700x700						33E7.25	33G7.25

Haaks / En drapeau - R/V		Fotolum / Photolum		
PVC-1mm	PVC-1,5mm	PVC	VIN.	
100x100	3361.25	100x100	3040.25	3030.25
125x125	3366.05	150x150	3046.25	3036.25
150x150	3365.05	200x200	3044.25	3034.25
200x200	3329.05	400x400	3045.25	
250x250				
300x300				
400x400				



Panoram.		Panoram. - Fotolum / Photolum		Plafond - R/V		Plafond - Fotolum / Photolum - R/V		Haaks / En drapeau - Fotolum / Photolum - R/V	
PVC-1mm	PVC-1,5mm	PVC		PVC-1mm	PVC-1,5mm	PVC-1mm		PVC-1mm	
200x100	332C.60	300x150	3043.60	150x150	3365.05PL	150x150	3081.25PL	150x150	3081.25
300x150	3324.60	400x200	3045.60	200x200	3329.05PL			200x200	3082.25
400x200	3326.60			400x400	3364.05PL				
600x300	332F.60								



Plat		Plat - Fotolum / Photolum		Haaks / En drapeau - R/V		Haaks / En drapeau - Fotolum / Photolum - R/V	
Alu anod. - 1,5mm		Alu anod. - 1,5mm		Alu anod. - 1,5mm		Alu anod. - 1,5mm	
125x125	331B.25	150x150	301A.25	125x125	331H.25	150x150	3011.25
150x150	331A.25			150x150	3311.25		



Zwarte eindkappen / Finition noire		Zwarte eindkappen / Finition noire - Fotol. / Photol.		Zwarte eindkappen / Finition noire - R/V		Zwarte eindkappen / Finition noire - Fotol. / Photol. - R/V	
Alu anod. - 1,5mm		Alu anod. - 1,5mm		Alu anod. - 1,5mm		Alu anod. - 1,5mm	
125x125	33PB.25	150x150	30PA.25	125x125	33PH.25	150x150	30P1.25
150x150	33PA.25			150x150	33P1.25		



Zwarte eindkappen - Hangend Finition noire - Suspendu		Zwarte eindkappen - Hangend - Fotolum Finition noire - Suspendu - Photolum		Muur - Bevestigingen inbegr. Mur - Fixations incl.		Muur - Bevestigingen inbegr. - Fotolum Mur - Fixations incl. - Photolum	
Alu anod. - 1,5mm		Alu anod. - 1,5mm		Plexi 6mm		Plexi 6mm	
125x125	33PS.25	150x150	30PU.25	150x150	5141.40	150x150	51A1.40
150x150	33PU.25			200x200	5142.40	200x200	51A2.40



Zijwaarts - Bevestigingen inbegr. Latéral - Fixations incl.			Zijwaarts - Bevestigingen inbegr. - Fotolum Latéral - Fixations incl. - Photolum			Hangend - Bevestigingen inbegr. Suspendu - Fixations incl.			Hangend - Bevestigingen inbegr. - Fotolum Suspendu - Fixations incl. - Photolum		
Plexi 6mm	Recto	R/V	Plexi 6mm	Recto	R/V	Plexi 6mm	Recto	R/V	Plexi 6mm	Recto	R/V
150x150	5541.40	5241.40	150x150	55A1.40	52A1.40	150x150	5341.40	5441.40	150x150	53A1.40	54A1.40
200x200	5542.40	5242.40	200x200	55A2.40	52A2.40	200x200	5342.40	5442.40	200x200	53A2.40	54A2.40

PROTECTION INCENDIE

BRANDBESTRIJDING

# BRANDBESTRIJDING

# PROTECTION INCENDIE



PP	VIN.	PP-R/V	FOREX 5mm	FOREX 5mm - R/V
50x50	3330.09			
100x100	3321.09	3331.09		
150x150	332A.09	333A.09		
200x200	3322.09	3332.09	33J2.09	
300x300	3323.09	3333.09		33G3.09
400x400	3324.09	3334.09	33E4.09	33G4.09
500x500	3325.09	3335.09	33E5.09	33G5.09
600x600	3326.09	3336.09	33E6.09	33G6.09
700x700			33E7.09	33G7.09

Haaks / En drapeau - R/V		Fotolum / Photolum		
PVC-1mm	PVC-1,5mm	PVC	VIN.	
100x100	3361.09	100x100	3040.09	3030.09
125x125	3366.02	150x150	3046.09	3036.09
150x150	3365.02	200x200	3044.09	3034.09
200x200	3329.02	300x300	304F.09	
250x250	3362.02	400x400	3045.09	
300x300	3363.02			
400x400	3364.02			



Panoram.		Panoram. - Fotolum / Photolum		Plafond - R/V		Plafond - Fotolum / Photolum - R/V		Haaks / En drapeau - Fotolum / Photolum - R/V	
PVC-1mm	PVC-1,5mm	PVC		PVC-1mm		PVC-1mm		PVC-1mm	
200x100	332C.55	300x150	3043.55	150x150	3365.02PL			200x200	3082.09
300x150	3324.55	400x200	3045.55						
400x200	3326.55								
600x300	332F.55								



Plat		Plat - Fotolum / Photolum		Haaks / En drapeau - R/V		Haaks / En drapeau - Fotolum / Photolum - R/V	
Alu anod. - 1,5mm		Alu anod. - 1,5mm		Alu anod. - 1,5mm		Alu anod. - 1,5mm	
125x125	331B.09	150x150	301A.09	125x125	331H.09	150x150	3011.09
150x150	331A.09			150x150	331I.09		



Zwarte eindkappen / Finition noire		Zwarte eindkappen / Finition noire - Fotol. / Photol.		Zwarte eindkappen / Finition noire - R/V		Zwarte eindkappen / Finition noire - Fotol. / Photol. - R/V	
Alu anod. - 1,5mm		Alu anod. - 1,5mm		Alu anod. - 1,5mm		Alu anod. - 1,5mm	
125x125	33PB.09	150x150	30PA.09	125x125	33PH.09	150x150	30P1.09
150x150	33PA.09			150x150	33P1.09		



Zwarte eindkappen - Hangend / Finition noire - Suspendu		Zwarte eindkappen - Hangend - Fotolum / Finition noire - Suspendu - Photolum		Muur - Bevestigingen inbegr. / Mur - Fixations incl.		Muur - Bevestigingen inbegr. - Fotolum / Mur - Fixations incl. - Photolum	
Alu anod. - 1,5mm		Alu anod. - 1,5mm		Plexi 6mm		Plexi 6mm	
125x125	33PS.09	150x150	30PU.09	150x150	5141.41	150x150	51A1.41
150x150	33PU.09			200x200	5142.41	200x200	51A2.41



Zijwaarts - Bevestigingen inbegr. / Latéral - Fixations incl.			Zijwaarts - Bevestigingen inbegr. - Fotolum / Latéral - Fixations incl. - Photolum			Hangend - Bevestigingen inbegr. / Suspendu - Fixations incl.			Hangend - Bevestigingen inbegr. - Fotolum / Suspendu - Fixations incl. - Photolum		
Plexi 6mm	Recto	R/V	Plexi 6mm	Recto	R/V	Plexi 6mm	Recto	R/V	Plexi 6mm	Recto	R/V
150x150	5541.41	5241.41	150x150	55A1.41	52A1.41	150x150	5341.41	5441.41	150x150	53A1.41	54A1.41
200x200	5542.41	5242.41	200x200	55A2.41	52A2.41	200x200	5342.41	5442.41	200x200	53A2.41	54A2.41

# BRANDBESTRIJDING

# PROTECTION INCENDIE



PP	VIN.	PP-R/V	FOREX R/V-5mm
50x50	3330.04		
100x100	3321.04	3331.04	
150x150	332A.04	333A.04	33JA.04
200x200	3322.04	3332.04	
300x300	3323.04	3333.04	
400x400	3324.04	3334.04	33G4.04
500x500	3325.04		
600x600	3326.04		



Haaks / En drapeau - R/V		Fotolum / Photolum	
PVC-1mm	PVC-1,5mm	PVC	
125x125	3366.07	100x100	3040.04
150x150	3365.07	150x150	3046.04
200x200	3329.07	200x200	3044.04
250x250	3362.07	300x300	304F.04
300x300	3363.07		
400x400	3364.07		



Panoram.		Panoram. - Fotolum / Photolum		Plafond - R/V		Plafond - Fotolum / Photolum - R/V		Haaks / En drapeau - Fotolum / Photolum - R/V	
PVC-1mm	PVC-1,5mm	PVC		PVC-1mm		PVC-1mm		PVC-1mm	
200x100	332C.53	300x150	3043.53	150x150	3365.07PL			200x200	3082.04
300x150	3324.53	400x200	3045.53						
400x200	3326.53								
600x300	332F.53								



Plat		Plat - Fotolum / Photolum		Haaks / En drapeau - R/V		Haaks / En drapeau - Fotolum / Photolum - R/V	
Alu anod. - 1,5mm		Alu anod. - 1,5mm		Alu anod. - 1,5mm		Alu anod. - 1,5mm	
125x125	331B.04	150x150	301A.04	125x125	331H.04	150x150	3011.04
150x150	331A.04			150x150	3311.04		



Zwarte eindkappen / Finition noire		Zwarte eindkappen / Finition noire - Fotol. / Photol.		Zwarte eindkappen / Finition noire - R/V		Zwarte eindkappen / Finition noire - Fotol. / Photol. - R/V	
Alu anod. - 1,5mm		Alu anod. - 1,5mm		Alu anod. - 1,5mm		Alu anod. - 1,5mm	
125x125	33PB.04	150x150	30PA.04	125x125	33PH.04	150x150	30P1.04
150x150	33PA.04			150x150	33P1.04		



Zwarte eindkappen - Hangend Finition noire - Suspendu		Zwarte eindkappen - Hangend - Fotolum Finition noire - Suspendu - Photolum		Muur - Bevestigingen inbegr. Mur - Fixations incl.		Muur - Bevestigingen inbegr. - Fotolum Mur - Fixations incl. - Photolum	
Alu anod. - 1,5mm		Alu anod. - 1,5mm		Plexi 6mm		Plexi 6mm	
125x125	33PS.04	150x150	30PU.04	150x150	5141.44	150x150	51A1.44
150x150	33PU.04			200x200	5142.44	200x200	51A2.44



Zijwaarts - Bevestigingen inbegr. Latéral - Fixations incl.			Zijwaarts - Bevestigingen inbegr. - Fotolum Latéral - Fixations incl. - Photolum			Hangend - Bevestigingen inbegr. Suspendu - Fixations incl.			Hangend - Bevestigingen inbegr. - Fotolum Suspendu - Fixations incl. - Photolum		
Plexi 6mm	Recto	R/V	Plexi 6mm	Recto	R/V	Plexi 6mm	Recto	R/V	Plexi 6mm	Recto	R/V
150x150	5541.44	5241.44	150x150	55A1.44	52A1.44	150x150	5341.44	5441.44	150x150	53A1.44	54A1.44
200x200	5542.44	5242.44	200x200	55A2.44	52A2.44	200x200	5342.44	5442.44	200x200	53A2.44	54A2.44

# BRANDBESTRIJDING

# PROTECTION INCENDIE



			Fotolum / Photolum					Fotolum / Photolum	
PP	VIN.		PVC		PP	VIN.		PVC	
150x150	332A.N2	333A.N2	150x150	3046.N2	150x150	332A.NO	333A.NO	150x150	3046.NO
200x200	3322.N2	3332.N2	200x200	3044.N2	200x200	3322.NO	3332.NO	200x200	3044.NO
300x300	3323.N2				300x300	3323.NO			



			Haaks / En drapeau - R/V					Fotolum / Photolum		
PP	VIN.		PVC-1mm	PVC-1,5mm	PP	VIN.		PVC		
150x150	332A.90		200x200	3329.90	3363.90	150x150	332A.M9	333A.M9	150x150	3046.M9
200x200	3322.90	3332.90			200x200	3322.M9	3332.M9	200x200	3044.M9	
300x300	3323.90	3333.90			300x300	3323.M9	3333.M9			
400x400	3324.90									



			Fotolum / Photolum			Plat		Haaks / En drapeau - R/V			
PP	VIN.		PP	VIN.		PVC	Alu anod. - 1,5mm		Alu anod. - 1,5mm		
100x100	3321.N1	3331.N1	100x100	3321.07	3331.07	150x150	3046.07	125x125	331B.07	125x125	331H.07
200x200	3322.N1	3332.N1	150x150	332A.07	333A.07	150x150	331A.07	150x150	3311.07		
300x300	3323.N1	3333.N1	200x200	3322.07	3332.07						
			300x300	3323.07	3333.07						
			400x400	3334.07							



Zwarte eindkappen / Finition noire			Fotolum / Photolum			Plat			
Alu anod. - 1,5mm			PP	VIN.		PVC		Alu anod.	
125x125	33PB.07		100x100	3331.N3		100x100	3040.N3	125x125	331B.N3
150x150	33PA.07		150x150	332A.N3	333A.N3	150x150	3046.N3	150x150	331A.N3
			200x200	3322.N3	3332.N3				



			Fotolum / Photolum		Panoram.		Panoram. - Fotolum / Photolum		Plat		
PP	VIN.		PVC		PVC-1mm		PVC		Alu anod. - 1,5mm		
100x100	3321.16	3331.16	100x100	3040.16	300x150	3324.54	300x150	3043.16	125x125	331B.16	
150x150	332A.16	333A.16	150x150	3046.16	400x200	3326.54			150x150	331A.16	
200x200	3322.16	3332.16	200x200	3044.16							
300x300	3323.16	3333.16									



Gebruik steeds een zuurvrije verlijming.  
Utilisez toujours une fixation sans acides.



Pag. 179

Haaks / En drapeau - R/V		Zwarte eindkappen / Finition noire		Zwarte eindkappen / Finition noire - R/V		Zwarte eindkappen - Hangend Finition noire - Suspendu	
Alu anod. - 1,5mm		Alu anod. - 1,5mm		Alu anod. - 1,5mm		Alu anod. - 1,5mm	
125x125	331H.16	33PB.16		33PH.16		33PS.16	
150x150	3311.16	33PA.16		33P1.16		33PU.16	

# BRANDBESTRIJDING

# PROTECTION INCENDIE

PROTECTION INCENDIE

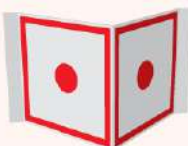
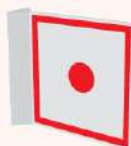
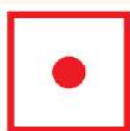

HIER UW TEKST  
ICI VOTRE TEXTE

PP		VIN.		Haaks / En drapeau - R/V		Panoram.		PP		VIN.	
				PVC-1mm		PVC-1mm					
100x100	3321.19	3331.19	200x200	3329.19	300x450	3324.64	100x100	3321.06	3331.06	140x200	6222.MT 6232.MT
150x150	332A.19						200x200	3322.06	3332.06		
200x200	3322.19	3332.19					300x300	3323.06	3333.06		
300x300	3323.19						400x400	3324.06			



PP		VIN.		PVC		VIN.		Panoram.		Haaks / En drapeau - R/V	
								PVC-1mm		PVC-1mm	
100x100	3321.32	3331.32	200x200	3044.32	3034.32	200x100	332C.32	150x150	3365.32		
150x150	332A.32	333A.32				300x150	3324.32	200x200	3329.32		
200x200	3322.32	3332.32				400x200	3326.32				
300x300	3323.32	3333.32									



Plat		Zijwaarts - Bevestigingen inbegr. Latéral - Fixations incl.		Muur - Bevestigingen inbegr. Mur - Fixations incl.		Hangend - Bevestigingen inbegr. Suspendu - Fixations incl.	
Alu anod. - 1,5mm				Plexi 6mm			
125x125	331B.32	150x150	5141.45	5241.45	5441.45		
150x150	331A.32						



PP		VIN.		PP-R/V		FOREX 5mm		FOREX R/V-5mm		Fotolum / Photolum		Haaks / En drapeau - R/V	
										PVC		VIN.	
100x100	3321.14	3331.14				100x100	3040.14			200x200	3329.14		
150x150	332A.14	333A.14				150x150	3046.14	3036.14		300x300		3363.14	
200x200	3322.14	3332.14	33J2.14			200x200	3044.14						
300x300	3323.14	3333.14											
400x400	3324.14	3334.14		33E4.14	33G4.14								
500x500	3325.14			33E5.14	33G5.14								
600x600	3326.14			33E6.14	33G6.14								
700x700				33E7.14	33G7.14								



Plat		Haaks / En drapeau - R/V		Zwarte eindkappen / Finition noire		Fotolum / Photolum		
Alu anod. - 1,5mm						PP		
						VIN.		
125x125	331B.14	331H.14	33PB.14	100x100	3321.38	3331.38	100x100	3040.38
150x150	331A.14	331I.14	33PA.14	150x150	332A.38	333A.38	150x150	3046.38
				200x200	3322.38	3332.38	200x200	3044.38
				300x300	3323.38	3333.38		

BRANDBESTRIJDING

# BRANDBESTRIJDING

# PROTECTION INCENDIE



Panoram.

Fotolum / Photolum

PP	VIN.	PVC-1mm	PP	VIN.	PVC	VIN.	PP	VIN.					
100x100	3321.00	3331.00	300x50	3324.50	100x100	3321.34	3331.34	200x200	3044.34	150x150	333A.48	100x100	3331.46
150x150	332A.00	400x200	3326.50	200x200	3322.34	3332.34	300x300	3323.34	3333.34	300x300	3323.46		
200x200	3322.00												
300x300	3323.00												
600x600	3328.00												



Fotolum / Photolum

Plat

PP	VIN.	PVC	Alu anod.	VIN.	PP	VIN.	Greenline			
100x100	3321.15	3331.15	100x100	3040.15	125x125	331B.15	Ø 50mm	3330.18A		
150x150	332A.15	333A.15	150x150	3046.15	150x150	331A.15	50x50	3330.18		
200x200	3322.15	3332.15	200x200	3044.15			100x100	3321.18	3331.18	
300x300	3323.15	3333.15					200x200	3322.18	3332.18	33U2.18
							300x300	3323.18	3333.18	
							400x400	3334.18		

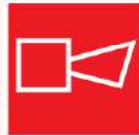

Fotolum / Photolum

PP	VIN.	PP	VIN.	PP	VIN.	PVC			
100x100	3321.47	3331.47	100x100	3331.43	100x100	3321.17	3331.17	100x100	3040.17
200x200	3322.47	3332.47	200x200	3322.43	150x150	332A.17	200x200	3044.17	
					200x200	3322.17	3332.17		

## Combipictogrammen

## Pictogrammes combinés

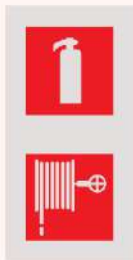

Alu anod.	Alu anod. - Fotolum / Photolum		
Plat	Haaks / Drap - R/V		
125x233	331C.01	150x275	301K.01
150x275	3312.01	331K.01	



PP	Fotolum / Photolum	Plexi 6mm - Bevestigingen inbegr. Plexi 6mm - Fixations incl.	Plexi 6mm - Fotolum - Bevestigingen inbegr. Plexi 6mm - Photolum - Fixations incl.							
PP	PVC	Muur/Mur	Zijw. / Lat. R/V	Plaf.R/V	Muur/Mur	Zijw. / Lat. R/V	Plaf.R/V			
100x200	3391.01	150x300	3092.01	150x300	5143.F7	5243.F7	5443.F7	51A3.F7	52A3.F7	54A3.F7
150x300	3392.01	200x400	3093.01							
200x400	3393.01									

# BRANDBESTRIJDING

# PROTECTION INCENDIE

## Combipictogrammen

## Pictogrammes combinés



Panoram. Panoram.		Panoram. - Fotolum Panoram. - Photolum		Haaks - R/V En drapeau - R/V		Haaks - Fotolum - R/V En drapeau - Photolum - R/V	
PVC-1mm	PVC-1,5mm	PVC		PVC-1mm	PVC-1,5mm	PVC	
200x200	3351.01	300x300	3052.01	100x200	3371.01	200x400	3072.01
300x300	3352.01	400x400	3053.01	150x300	3372.01		3073.01
400x400	3353.01			200x400	3373.01		



PP		Fotolum / Photolum		Plexi 6mm - Bevestigingen inbegr. Plexi 6mm - Fixations incl.			Plexi 6mm - Fotolum - Bevestigingen inbegr. Plexi 6mm - Photolum - Fixations incl.			
		PVC		Muur/Mur	Zijw. / Lat. R/V	Plaf./R/V	Muur/Mur	Zijw. / Lat. R/V	Plaf./R/V	
100x200	3391.02	150x300	3092.02	150x300	5143.F8	5243.F8	5443.F8	51A3.F8	52A3.F8	54A3.F8
150x300	3392.02	200x400	3093.02							
200x400	3393.02									



Panoram. Panoram.		Panoram. - Fotolum Panoram. - Photolum		Haaks - R/V En drapeau - R/V		Haaks - Fotolum - R/V En drapeau - Photolum - R/V	
PVC-1mm	PVC-1,5mm	PVC		PVC-1mm	PVC-1,5mm	PVC	
200x200	3351.02	300x300	3052.02	100x200	3371.02	200x400	3073.02
300x300	3352.02	400x400	3053.02	150x300	3372.02		
400x400	3353.02			200x400	3373.02		



PP		Fotolum / Photolum		Plexi 6mm - Bevestigingen inbegr. Plexi 6mm - Fixations incl.			Plexi 6mm - Fotolum - Bevestigingen inbegr. Plexi 6mm - Photolum - Fixations incl.			
		PVC		Muur/Mur	Zijw. / Lat. R/V	Plaf./R/V	Muur/Mur	Zijw. / Lat. R/V	Plaf./R/V	
100x200	3391.03	150x300	3092.03	150x300	5143.F9	5243.F9	5443.F9	51A3.F9	52A3.F9	54A3.F9
150x300	3392.03	200x400	3093.03							
200x400	3393.03									

# BRANDBESTRIJDING

# PROTECTION INCENDIE

## Combipictogrammen

## Pictogrammes combinés

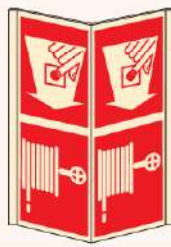
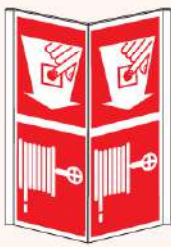

Panoram. Panoram.		Panoram. - Fotolum Panoram. - Photolum		Haaks - R/V En drapeau - R/V		Haaks - Fotolum - R/V En drapeau - Fotolum - R/V	
PVC-1mm	PVC-1,5mm	PVC		PVC-1mm	PVC-1,5mm	PVC	
200x200	3351.03	300x300	3052.03	100x200	3371.03	200x400	3073.03
300x300	3352.03	400x400	3053.03	150x300	3372.03		
400x400	3353.03			200x400	3373.03		



Panoram. Panoram.		Panoram. - Fotolum Panoram. - Photolum		Haaks - R/V En drapeau - R/V		Haaks - Fotolum - R/V En drapeau - Fotolum - R/V	
PVC-1mm	PVC-1,5mm	PVC		PVC-1,5mm	PVC		
200x300	3354.01	200x300	3054.01	150x450	3377.01	200x600	3078.01
300x450	3356.01	300x450	3056.01	200x600	3378.01		
400x600	3357.01	400x600	3057.01				



PP		Fotolum / Photolum			Plexi 6mm - Bevestigingen inbegr. Plexi 6mm - Fixations incl.			Plexi 6mm - Fotolum - Bevestigingen inbegr. Plexi 6mm - Photolum - Fixations incl.			
		PVC	Muur/Mur	Zijw. / Lat. R/V	Plaf./R/V	Muur/Mur	Zijw. / Lat. R/V	Plaf./R/V	Muur/Mur	Zijw. / Lat. R/V	Plaf./R/V
100x300	3396.01	150x450	3097.01	150x450	5144.H0	5244.H0	5444.H0	51A4.H0	52A4.H0	54A4.H0	
150x450	3397.01	200x600	3098.01								
200x600	3398.01										



PP		Fotolum / Photolum		Muur - Bevestigingen inbegr. Mur - Fixations incl.		Muur - Bevestigingen inbegr. - Fotolum Mur - Fixations incl. - Photolum	
		PVC	Plexi 6mm	Plexi 6mm			
400x200	3393.50	400x200	3093.J3	400x200	5145.J5	400x200	51A5.J5

## BRANDBESTRIJDING - TEKSTEN

## PROTECTION INCENDIE - TEXTES

BRANDALARM			BIJ BRANDALARM HARD DUWEN			BLUSDEKEN			BRANDEUR DICHTHOUDEN AUB		
	PP	VIN.		PP	VIN.		PP	VIN.		PP	VIN.
210x74	1821.11	1831.11		1821.21	1831.21		1821.15	1831.15		1821.17	1831.17

BRANDKRAAN			BRANDWERENDE DEUR			BRANDEUR			NOODSTOP		
	PP	VIN.		PP	VIN.		PP	VIN.		PP	VIN.
210x74	1821.88	1831.88		1821.89	1831.89		1821.16	1831.16		1821.13	1831.13

BRANDEUR VERBODEN OBSTAKELS TE PLAATSEN			BRANDWEER			SPRINKLER			BRANDEURMELDCENTRALE		
	PP	VIN.		PP	VIN.		PP	VIN.		PP	VIN.
210x74	1821.60	1831.60		1821.19	1831.19		1821.12	1831.12		1821.23	1831.23

GASAFSLUITER			ROOK- EN WARMTEAFVOER			STOOKLOKAAL			VEILIGHEIDSMATERIALEN		
	PP	VIN.		PP	VIN.		PP	VIN.		PP	VIN.
210x74	1821.18	1831.18		1821.14	1831.14		1821.99	1831.99		1821.20	1831.20

UW TEKST / VOTRE TEXTE		
	PP	VIN.
210x74	1821.MT	1831.MT

ALARME INCENDIE			COUVERTURE ANTI-FEU			ARRET D'URGENCE			CHAUFFERIE		
	PP	VIN.		PP	VIN.		PP	VIN.		PP	VIN.
210x74	1821.07	1831.07		1821.24	1831.24		1821.03	1831.03		1821.22	1831.22

COLONNE SECHE			NE PAS UTILISER SUR FLAMME GAZ			COMMANDE DESENFUMAGE			VANNE GAZ		
	PP	VIN.		PP	VIN.		PP	VIN.		PP	VIN.
210x74	1821.87	1831.87		1821.10	1831.10		1821.02	1831.02		1821.06	1831.06

VANNE ARRET GAZ			FERMER LA VANNE GAZ AVANT D'UTILISER L'EXTINCTEUR			COMMANDE EVACUATION DE FUMEE			PORTE COUPE FEU NE METTEZ PAS D'OBSTACLE A LA FERMETURE		
	PP	VIN.		PP	VIN.		PP	VIN.		PP	VIN.
210x74	1821.08	1831.08		1821.09	1831.09		1821.01	1831.01		1821.04	1831.04

PORTE COUPE FEU MAINTENIR FERMEE		
	PP	VIN.
210x74	1821.05	1831.05

**BRAND-ALARM**

**VEILIGHEIDSMATERIALEN**

**BMZ**

	PP	VIN.		PP	VIN.		PP	VIN.
400x250	1723.36	1733.36	300x250	1723.30	1733.30	210x74	1821.38	1831.38



# LOCATIEAANDUIDING Hydrant

# EMPLACEMENT TECHNIQUE Bouches d'incendie

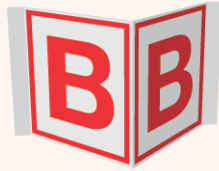

Panoram.  
Panoram.

	PP	VIN.
100x100	3321.04B	3331.04B
200x250	332E.04	333E.04

	PVC-1mm
430x270	3326.51



3D - NIET REFL. - 3 Zijden  
3D - NON REFL. - 3 Faces

	Alu Pl.
200x250	33Y2.04



Bij de 3D borden zijn de beugels niet inbegrepen.  
Pour les panneaux 3D les brides ne sont pas incluses.

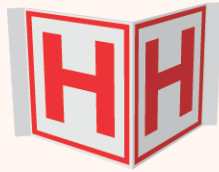

Panoram.  
Panoram.

	PP	VIN.
100x100	3321.05	3331.05
200x250	332E.05	333E.05

	PVC-1mm
430x270	3326.58



3D - NIET REFL. - 3 Zijden  
3D - NON REFL. - 3 Faces

	Alu Pl.
200x250	33Y2.05

## Palen & Toebehoren

## Poteaux & Accessoires

### Palen Poteaux

Lengte Longueur	Galva Diam. 51mm	Galva Diam. 76mm	Rood Diam. 51mm
2500mm	K3114	K3214	K3172
3000mm	K3115	K3215	K3173
3500mm	K3116	K3216	K3174
4000mm	K3117	K3217	K3175

### Paaldoppen Calottes

Diam. Diam.	
51mm	K3101
76mm	K3201



### Paalvoeten Pieds d'encrage

Diam. Diam.	Gew. Poids	Beton Beton
51mm	33kg	K3108
76mm	52kg	K3208



### Haakse bevestigingsarm met dop Bras en drapeau avec calotte

Lengte Longueur	Diam 76mm
600mm	WH60
400mm	WH76

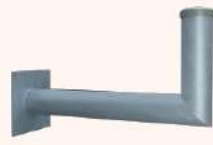

### Bevestigingsarm vork Bras support fourche

Lengte Longueur	Diam 60mm
960mm	WHX2



Bevestigen op een paal met max ø80mm  
A fixer sur un poteau de max ø80mm

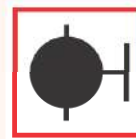

Fotolum / Photolum

	PP	VIN.	PP	VIN.	SIGNICOLOR 1,5mm	PVC	VIN.	PP			
200x250	332E.07	333E.07	100x75	1720.B1	1730.B1	1710.B1	200x150	3044.B1	3034.B1	200x200	6222.09
			200x150	1721.B1	1731.B1	1711.B1	400x300	3098.B1			
			250x200	1722.B1	1732.B1	1712.B1					
			400x300	1723.B1	1733.B1	1713.B1					



Fotolum / Photolum

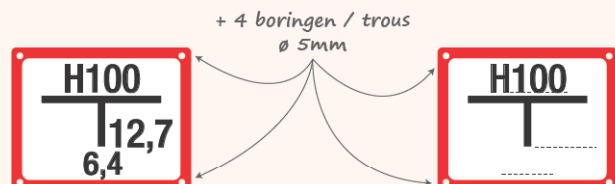

Voorbeeld / Exemple

	PP	VIN.	SIGNICOLOR 1,5mm	PVC	
200x150	1721.F1	1731.F1	1711.F1	200x150	3044.F1
250x200	1722.F1	1732.F1			
400x300	1723.F1	1733.F1	1713.F1		

	PP	DIBOND 3mm
250x200	332L.MT	331L.MT

LOCATIEAANDUIDING

EMPLACEMENT TECHNIQUE

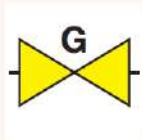

	PP	VIN.
120x120	6221.01	6231.01
200x200	6222.01	6232.01

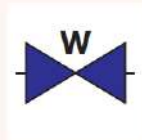

	PP	VIN.
120x120	6221.02	6231.02
200x200	6222.02	6232.02

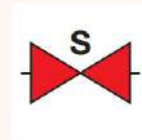

	PP	VIN.
120x120	6221.A3	6231.A3
200x200	6222.A3	6232.A3



	PP	VIN.
120x120	6221.05	6231.05
200x200	6222.05	6232.05

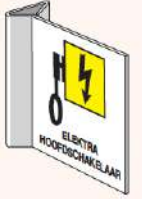

	PVC - 1mm
150x150	6271.05



	PP	VIN.
120x120	6221.06	6231.06
200x200	6222.06	6232.06



	PP	VIN.
150x150	3522.67	3532.67



	Alu anod.	Plat
150x150	351A.67	



	PP	VIN.
150x150	3522.65	3532.65



	Alu anod.	Plat
150x150	351A.65	



	PP	VIN.
150x150	362A.25	363A.25



	Alu anod.	Plat
150x150	361A.25	



	PP	VIN.
120x120	6221.03	6231.03
200x200	6222.03	6232.03



	PP	VIN.
120x120	6221.04	6231.04
200x200	6222.04	6232.04



	PP	VIN.
120x120	6221.A1	6231.A1
200x200	6222.A1	6232.A1



	PP	VIN.
120x120	6221.A2	6231.A2
200x200	6222.A2	6232.A2



	PP	VIN.
100x100	3321.33	3331.33
150x150	332A.33	333A.33
200x200	3322.33	3332.33



	PP	VIN.
120x120	6221.A0	6231.A0
200x200	6222.A0	6232.A0



	PP	VIN.
100x100	6220.07	6232.07
200x200	6222.07	6232.07



	PP	VIN.
100x100	6220.08	6230.08



	PP
Ø 200mm	3322.21
Ø 300mm	3323.21



	PP
Ø 200mm	3322.B0



	PP
Ø 200mm	3322.23
Ø 300mm	3323.23



	PP
Ø 200mm	3322.24
Ø 300mm	3323.24



	PP
100x180	3322.81



	PP	VIN.		PP	VIN.		PP	VIN.
210x297	3823.D0	3833.D0	210x297	3823.D3	3833.D3	210x297	3823.33	3833.33



	PP	VIN.		PP	VIN.		PP	VIN.
210x297	3823.D1	3833.D1	210x297	3823.D4	3833.D4	210x297	3823.D5	3833.D5



	PP	VIN.		PP	VIN.		PP	VIN.
210x297	3823.04	3833.04	210x297	3823.08	3833.08	210x297	3823.11	3833.11



	PP	VIN.		PP	VIN.		PP	VIN.
210x297	3823.03	3833.03	210x297	3823.15	3833.15	210x297	3823.13	3833.13

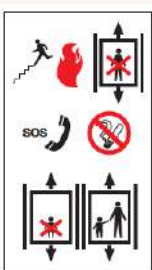

Alarm lift  
Alarme ascenseur

	PP	VIN.	Alu Plat
115x195	3322.05	3332.05	331A.05

# KEURINGSTICKERS

# PASTILLES CALENDRIER



Vel Feuille	Standaard Standard	Ultr.des.	UV Protect	Standaard Standard	Ultr.des.	UV Protect	Standaard Standard	Ultr.des.	UV Protect
20mm-15sts. 20mm-15pcs	4432.02N	44F2.02N	44L2.02N	4432.03N	44F2.03N	44L2.03N	4432.02VK	44F2.02VK	44L2.02VK
30mm-9sts. 30mm-9pcs	4433.02N	44F3.02N	44L3.02N	4433.03N	44F3.03N	44L3.03N	4433.02VK	44F3.02VK	44L3.02VK



Vel Feuille	Standaard Standard	Ultr.des.	UV Protect	Standaard Standard	Ultr.des.	UV Protect	Standaard Standard	Ultr.des.	UV Protect
20mm-15sts. 20mm-15pcs	4432.03VK	44F2.03VK	44L2.03VK	4432.02VC	44F2.02VC	44L2.02VC	4432.03VC	44F2.03VC	44L2.03VC
30mm-9sts. 30mm-9pcs	4433.03VK	44F3.03VK	44L3.03VK	4433.02VC	44F3.02VC	44L3.02VC	4433.03VC	44F3.03VC	44L3.03VC



Vel Feuille	Standaard Standard	Ultr.des.	UV Protect	Standaard Standard	Ultr.des.	UV Protect	Standaard Standard	Ultr.des.	UV Protect
20mm-15sts. 20mm-15pcs	4432.02NL	44F2.02NL	44L2.02NL	4432.03NL	44F2.03NL	44L2.03NL	4432.02F	44F2.02F	44L2.02F
30mm-9sts. 30mm-9pcs	4433.02NL	44F3.02NL	44L3.02NL	4433.03NL	44F3.03NL	44L3.03NL	4433.02F	44F3.02F	44L3.02F



Vel Feuille	Standaard Standard	Ultr.des.	UV Protect	Standaard Standard	Ultr.des.	UV Protect	Standaard Standard	Ultr.des.	UV Protect
20mm-15sts. 20mm-15pcs	4432.03F	44F2.03F	44L2.03F	4432.02PI	44F2.02PI	44L2.02PI	4432.03PI	44F2.03PI	44L2.03PI
30mm-9sts. 30mm-9pcs	4433.03F	44F3.03F	44L3.03F	4433.02PI	44F3.02PI	44L3.02PI	4433.03PI	44F3.03PI	44L3.03PI



Vel Feuille	Standaard Standard	Ultr.des.	UV Protect	Standaard Standard	Ultr.des.	UV Protect	Standaard Standard	Ultr.des.	UV Protect
20mm-15sts. 20mm-15pcs	4432.02CA	44F2.02CA	44L2.02CA	4432.03CA	44F2.03CA	44L2.03CA	4432.02NI	44F2.02NI	44L2.02NI
30mm-9sts. 30mm-9pcs	4433.02CA	44F3.02CA	44L3.02CA	4433.03CA	44F3.03CA	44L3.03CA	4433.02NI	44F3.02NI	44L3.02NI



Vel Feuille	Standaard Standard	Ultr.des.	UV Protect
20mm-15sts. 20mm-15pcs	4432.03NI	44F2.03NI	44L2.03NI
30mm-9sts. 30mm-9pcs	4433.03NI	44F3.03NI	44L3.03NI

**Standaard = standaard permanent**  
**Ultr.des = fragmenteerbare vinyl**  
**UV-protect = extra UV beschermlaag**

**Standard = standard permanent**  
**Ultr.des = vinyle fragmentable**  
**UV-protect = couche anti-UV**



Perforatietang  
Pince à perforer J698

# KEURINGSTICKERS



afmetingen Dimensions	st/vel pcs/feuille	Standaard Standard	Ultr.des.	UV Protect
20mm	15	4432.23	44F2.23	44L2.23
30mm	9	4433.23	44F3.23	44L3.23



20mm	15	4432.24	44F2.24	44L2.24
30mm	9	4433.24	44F3.24	44L3.24



20mm	15	4432.25	44F2.25	44L2.25
30mm	9	4433.25	44F3.25	44L3.25



20mm	15	4432.26	44F2.26	44L2.26
30mm	9	4433.26	44F3.26	44L3.26

# PASTILLES CALENDRIER



afmetingen Dimensions	st/vel pcs/feuille	Standaard Standard	Ultr.des.	UV Protect
20mm	15	4436.A3	44F6.A3	44L6.A3
30mm	9	4437.A3	44F7.A3	44L7.A3



20mm	15	4436.A4	44F6.A4	44L6.A4
30mm	9	4437.A4	44F7.A4	44L7.A4



20mm	15	4436.A5	44F6.A5	44L6.A5
30mm	9	4437.A5	44F7.A5	44L7.A5



20mm	15	4436.A6	44F6.A6	44L6.A6
30mm	9	4437.A6	44F7.A6	44L7.A6

Liftkamer

1004

Beeldmerk bedrijf  
slang beproefd  
NEN-EN 671-3

Andere formaten en modellen op aanvraag.  
Autres formats et modèles sur demande.



# BEOORDELINGSETIKETTEN

GRATIS	RETOUR	URGENT	AFGEKEURD
GRATIS	RETOUR	URGENT	AFGEKEURD
GRATIS	RETOUR	URGENT	AFGEKEURD
GRATIS	RETOUR	URGENT	AFGEKEURD
GRATIS	RETOUR	URGENT	AFGEKEURD

# ETIQUETTES A REMARQUES

TEKST	VIN. 50x20mm (5 per vel / 5 par feuille)				
	Zwart/Oranje	Zwart/Rood	TEXTE	Noir/Orange	Noir/Rouge
AFGEKEURD	1637.10	1637.50	GRATUIT	1637.19	1637.59
BELANGRIJK	1637.11	1637.51	IMPORTANT	1637.20	1637.60
BLOQUE	1637.12	1637.52	NIET CONFORM	1637.21	1637.61
CONFORM	1637.13	1637.53	NON CONFORM	1637.22	1637.62
DECLASSE	1637.14	1637.54	REFUSE	1637.23	1637.63
DRINGEND	1637.15	1637.55	RETOUR	1637.24	1637.64
GEBLOKKEERD	1637.16	1637.56	TE CONTROLEREN	1637.25	1637.65
GEWEIGERD	1637.17	1637.57	A CONTROLER	1637.26	1637.66
GRATIS	1637.18	1637.58	URGENT	1637.27	1637.67

# CE-ETIKETTEN



VIN.	
Ø 30mm (10 per vel - 10 par feuille)	1633.01
Ø 35mm (3 per vel - 3 par feuille)	1634.01
Ø 50mm (3 per vel - 3 par feuille)	1636.01
Ø 90mm (per stuk - la pièce)	1638.01
Ø 100mm (per stuk - la pièce)	1639.01



VIN.	
20x10mm (52 per vel - 52 par feuille)	1632.02
35x25mm (5 per vel - 5 par feuille)	1635.02
50x35mm (5 per vel - 5 par feuille)	1637.02

# ETIQUETTES CE

## SIGN SERVICES

In samenwerking met een plaatsingsdienst kunnen wij voorzien in de uitvoering van uw signalisatieproject. Wij plaatsen uw borden, palen, belijningen,... en zorgen voor een correcte signalering binnen uw industriële gebouwen, parkings, winkels of kantoren.

De projecten, groot of klein, kunnen gerealiseerd worden in diverse materialen en formaten.

En collaboration nous exécutons votre projet de signalisation. Nous plaçons vos panneaux, poteaux, ... et assurons une signalisation appropriée au sein de vos bâtiments industriels, parkings, commerces ou bureaux.

Les projets, grands ou petits, peuvent être réalisés dans différents matériaux et formats.



Professionele plaatsing en uitvoering op maat.  
Wij zorgen voor de realisatie van uw borden en plannen.

Installation professionnelle et exécution sur mesure.  
Nous réalisons vos panneaux et plans.

# MINI PICTOGRAMMEN

# MINI PICTOGRAMMES

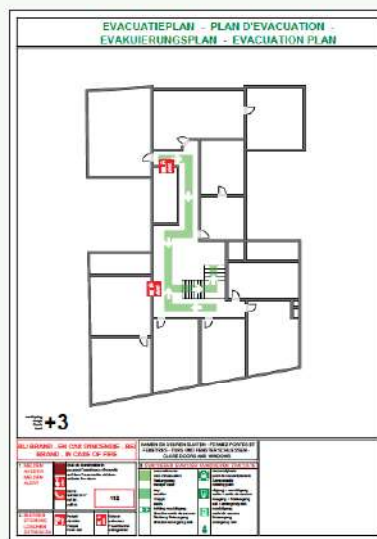
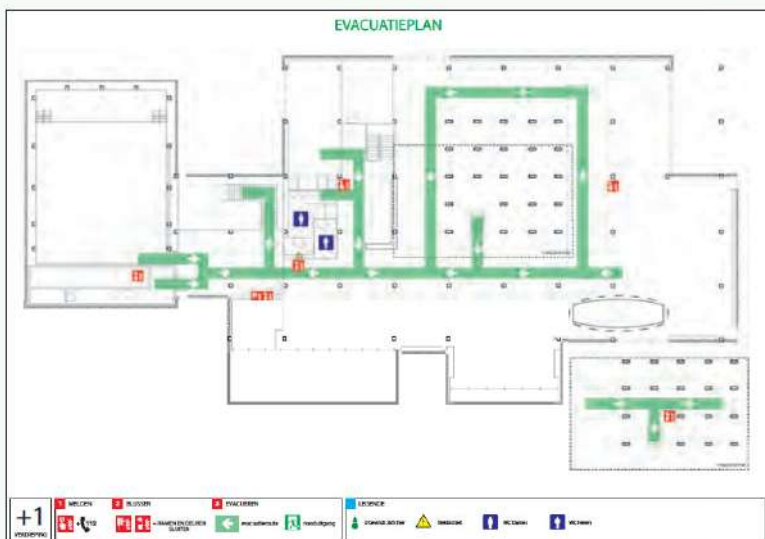

- Software en/of diensten
- Verschillende rapporten
- Controle en onderhoud
- Noodplanning
- Conform huidige wetgeving
- Voor meerdere preventiedomeinen

- Software et/ou services
- Élaboration de rapports
- Contrôle et maintenance
- Planification d'urgence
- Conformément à la législation en vigueur
- Pour différents domaines de la prévention

## MINI PICTOGRAMMEN

## MINI PICTOGRAMMES

### ISO 7010

### ISO 7010

154x 11x6 MP8640	52x 20x10 MP9640	154x 11x6 MP8641	52x 20x10 MP9641	154x 11x6 MP8642	154x 11x6 MP8643	154x 11x6 MP8644	154x 11x6 MP8645
126x 10x10 MP8605	54x 15x15 MP9605	126x 10x10 MP8602	20x 20x20 MP9602	126x 10x10 MP8600	54x 15x15 MP9600	126x 10x10 MP8601	54x 15x15 MP9601
126x 10x10 MP8603	54x 15x15 MP9603	126x 10x10 MP8646	5x 78x15 MP9580				

126x 5x5 MP7619	126x 10x10 MP8619	54x 15x15 MP9619	154x 6x11 MP8607	52x 10x20 MP9607	154x 11x6 MP8609	154x 11x6 MP8609	52x 20x10 MP9609
154x 11x6 MP8608	52x 20x10 MP9608	154x 11x6 MP8621	154x 11x6 MP8622	154x 11x6 MP8655	154x 11x6 MP8654	126x 10x10 MP8611	126x 10x10 MP8653

MINI PICTOGRAMMES































MINI PICTOGRAMMEN

# MINI PICTOGRAMMEN

# MINI PICTOGRAMMES

## Redding & evacuatie

## Evacuation & sauvetage

	54x 15x15 MP8610		15x 25x28 MP9610		54x 7x7 MP76A0		154x 11x6 MP8606		52x 20x10 MP8616	<b>MP8612-op 1 vel</b> <b>MP8612-sur 1 feuille</b>   126x6-10x      11x6-28x																										
<b>MP8613-op 1 vel</b> <b>MP8613-sur 1 feuille</b>  126x6-10x      11x6-28x		<b>MP8614-op 1 vel</b> <b>MP8614-sur 1 feuille</b>  126x6-10x      11x6-28x		<b>MP8615-op 1 vel</b> <b>MP8615-sur 1 feuille</b>  126x6-10x      11x6-28x		<b>MP8617-op 1 vel</b> <b>MP8617-sur 1 feuille</b>   20x10-26x      20x10-26x																														
	9x 9x		9x 9x		9x 9x		9x 9x		9x 9x		9x 9x		6x 6x		6x 6x		6x 6x		6x 6x		6x 6x		6x 6x		6x 6x		6x 6x		6x 6x		5x 5x		5x 5x		5x 5x	10x10 MP8652





















































## Brandbestrijding

## Protection incendie

ISO 7010

ISO 7010

	126x 10x10 MP8269		126x 10x10 MP8259		126x 10x10 MP8295	    32x      32x      32x      30x      10x10 MP8260			
---	----------------------	---	----------------------	---	----------------------	--	--	--	--

	126x 10x10 MP8294		126x 10x10 MP8292		154x 6x11 MP7100		81x 10x15 MP8100		36x 15x20 MP9100		154x 6x11 MP8103		81x 10x15 MP8101		36x 15x20 MP9101	
	81x 10x15 MP8102		25x 15x20 MP9102		81x 10x15 MP8105		36x 15x20 MP9105		126x 10x10 MP8150		54x 15x15 MP9106		54x 15x15 MP9108		126x 10x10 MP8141	
	54x 15x15 MP9141		126x 10x10 MP8109		54x 15x15 MP9109		81x 10x15 MP8110		81x 10x15 MP8112		126x 10x10 MP8121		81x 15x10 MP8123		81x 15x10 MP8146	
	126x 10x10 MP8149		126x 10x10 MP8148		126x 10x10 MP8202		54x 15x15 MP9148		54x 15x15 MP9202		126x 10x10 MP8203		54x 15x15 MP9203			
     63x      4x      27x      9x      5x						126x 10x10 MP9122	<b>Blusdeken</b>   52x      126x 20x10 MP8293      10x10 MP8228			126x 10x10 MP8200		126x 10x10 MP9200		126x 10x10 MP8201		
    3x      6x      4x      5x						54x 15x15 MP9201		126x 10x10 MP8204		54x 15x15 MP9204		200 10x15 MP8205		126x 10x10 MP8206		54x 15x15 MP9206

MINI PICTOGRAMMES













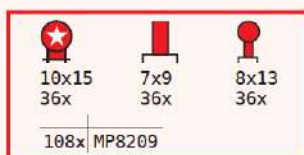
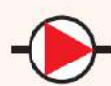





































MINI PICTOGRAMMEN

# MINI PICTOGRAMMEN

# MINI PICTOGRAMMES

## Brandbestrijding

## Protection incendie

																														
15x10	81x MP8207	15x15	54x MP9207	108x MP8209	15x10	81x MP8210	15x10	72x MP8211	15x15	54x MP9212	15x15	54x MP9213																		
																														
15x15	54x MP9214	15x15	54x MP9215	28x25	15x MP9216	5x5	126x MP7218	10x10	126x MP8218	15x15	54x MP9218	10x10	126x MP8219	10x15	81x MP8220															
																														
10x15	81x MP8221	10x10	126x MP8222	10x10	126x MP8223	10x10	126x MP8224	11x6	154x MP8225	15x10	81x MP9225	15x15	54x MP8226	10x10	126x MP8229															
																														
10x15	81x MP9229	10x10	126x MP8230	10x15	81x MP9230	10x10	126x MP8232	10x15	81x MP9232	10x10	126x MP8233	10x15	81x MP9233	11x6	154x MP8237															
																														
15x10	81x MP9234	9x	9x	15x20	18x MP8238	10x10	126x MP8239	10x10	126x MP8240	11x6	154x MP9240	10x10	154x MP8241	10x10	126x MP8243															
																														
10x10	126x MP8244	10x10	126x MP8245	10x10	126x MP8251	10x10	126x MP8280	16x11	154x MP8271	20x10	52x MP9271	<table border="1"> <thead> <tr> <th></th> <th>WATER/ EAU</th> <th>GAS/ GAZ</th> <th>SPRINKLER</th> <th>OMLOOP/ CIRCUIT</th> </tr> </thead> <tbody> <tr> <td>98x</td> <td>14x</td> <td>14x</td> <td>14x</td> <td>14x</td> </tr> <tr> <td>11x6</td> <td colspan="4">MP8217</td> </tr> </tbody> </table>					WATER/ EAU	GAS/ GAZ	SPRINKLER	OMLOOP/ CIRCUIT	98x	14x	14x	14x	14x	11x6	MP8217			
	WATER/ EAU	GAS/ GAZ	SPRINKLER	OMLOOP/ CIRCUIT																										
98x	14x	14x	14x	14x																										
11x6	MP8217																													

## Verbod

## Interdiction

ISO 7010

ISO 7010

															
10x10	126x MP7330	15x15	54x MP8330	20x20	20x MP9330	15x15	54x MP8301	20x20	20x MP9301	15x15	54x MP8331	15x15	54x MP8307	15x15	54x MP8302
															
20x20	20x MP9302	20x20	20x MP9314	10x10	126x MP7332	15x15	54x MP8332	20x20	20x MP9332	15x15	54x MP8308				
															
10x10	126x MP7300	15x15	54x MP8300	20x20	20x MP9300	15x15	54x MP8315	20x20	20x MP9315	15x15	54x MP8306	15x15	54x MP8305	15x15	54x MP8304
															
10x10	126x MP7313	15x15	54x MP8313	20x20	20x MP9313	15x15	54x MP8309	10x10	126x MP7303	15x15	54x MP8303	20x20	20x MP9303		

# MINI PICTOGRAMMEN

# MINI PICTOGRAMMES

## Gebod

## Obligation

ISO 7010

ISO 7010



Aantal	Formaat										
126x	10x10	MP8540	MP8541	MP8542	MP8544	MP8504	MP8505	MP8545			
20x	20x20	MP9540	MP9541	MP9542	MP9544	MP9504	MP9505	MP9545	MP9543		



Aantal	Formaat										
126x	10x10	MP8502	MP8500	MP8503	MP8507	MP8509	MP8501	MP8506			
20x	20x20	MP9502	MP9500	MP9503	MP9507	MP9509	MP9501	MP9506	MP9515	MP9510	

## Waarschuwing

## Avertissement

ISO 7010

ISO 7010



Aantal	Formaat										
126x	10x10	MP7406									
54x	15x15	MP8406	MP8400	MP8401	MP8404	MP8403	MP8405	MP8414	MP8402	MP8415	MP8407
15x	28x25	MP9406	MP9400	MP9401	MP9404	MP9403	MP9405	MP9414	MP9402	MP9415	MP9407



Aantal	Formaat								Aantal	Formaat			
126x	10x10								54x	15x15	MP8413		
54x	15x15	MP8411	MP8417	MP8416	MP8408	MP8409	MP8430	MP8431	20x	20x20	MP8432		
15x	28x25	MP9411	MP9417										

## Aanduiding

## Indication



Aantal	Formaat			Aantal	Formaat			Aantal	Formaat		
126x	10x10	MP8508		126x	10x10	MP8513	MP7620	MP8255	126x	10x10	MP8512
81x	10x15	MP9508	MP8511	20x	20x20			MP9355			

## Diversen

## Divers



Aantal	Formaat
5x	
80x18	MP9518

Uitgekapt / Découpé

U BENT HIER  
VOUS ETES ICI  
YOU ARE HERE

Aantal	Formaat
10x	
48x24	MP9517

Transp.vin. / Vin.transp.



Aantal	Formaat
126x	
Ø5mm	MP39C0



Aantal	Formaat
126x	
Ø5mm	MP39C1

# MINI PICTOGRAMMEN

# MINI PICTOGRAMMES

IMO

IMO

## VERKEER

## CIRCULATION

### GEBOD

### OBLIGATION

--	--

### VERBOD

### INTERDICTION

### GEVAAR

### DANGER

### VOORRANG

### PRIORITE

MINI PICTOGRAMMES

MINI PICTOGRAMMEN

# MINI PICTOGRAMMEN

# MINI PICTOGRAMMES

## VERKEER

## CIRCULATION

### AANWIJZING

### INDICATION

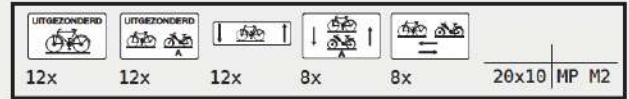
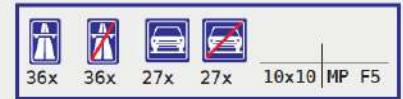

### PARKEREN

### STATIONNER

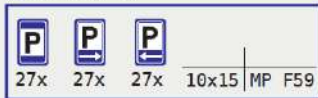

### DIVERSEN

### DIVERS



UW PLAN OMZETTEN IN DE PRAKTIJK?  
CONVERTIR VOTRE PLAN EN PRATIQUE?



Signalisatie pagina 227 - 237



Signalisation page 227 - 237

# BRANDBESTRIJDINGSMIDDELEN EQUIPEMENTS DE LUTTE CONTRE L'INCENDIE



3V



3V + koppelbaar / connectable



Autonoom brandalarm Type 4  
Alarme incendie autonome Type 4



Optisch - met pauzeknop / Optique - avec bouton de pause		Optisch en Thermisch / Optique et Thermique		126x242x77mm		Voor / pour J627 + J626	
Alkaline 2x1.5V	J701A	Lithium 10jr./10ann.	J702LH	9V-90db-IP42	J627	10x Sleutel / Clés	J627C



Brandalarm / Alarm incendie		CO-melder / Alarme CO		Sleutelkastje + Hamer / Boîte à clés + Marteau		Noodhamer met gordelmes / Brise vitre avec coupe ceinture	
93x93x59mm	J626	Alkaline 5jr./5ann.	JCO9B	Kastje / Boîte	KEY5	J239	
		Lithium 10jr./10ann.	JCO9X	Vervangglas / Verre de rechange	KEY5V2		



980x400mm Transp.		6L/KG PVC		6/9 L/KG PVC		6/9 L/KG PVC		2KG CO2 PVC		5KG CO2 PVC	
Hoës blusser / Housse extincteur		J140	J440	J441	J442	J443	J444				



Binnen/Interi.		270x755x220mm		360x915x210mm		382x830x255mm		230x610x220mm		230x555x220mm		230x555x220mm	
Koffer blusser / Boîte extincteur		J801	J804	J805	J817	J818	J819						



Binnen/Interi.		270x755x220mm		760x530x300mm		820x800x435mm		PE 225x295x42mm		Metaal / Métal 260x350x78mm	
Koffer PBM / Boîte EPI		J802	J816	J806	Koffer veiligheidsregister Boîte de registre de sécurité		NL FR	J222NL J222FR	J682NL J682FR		



Wandhouder voor blussers  
Support mural pour extincteurs



Enkellaags blusdeken - Niet voor frituurbranden  
Couverture Anti-feu 1 couche - Interdit pour incendie friteuse

Brandblusserdrager / Porte-extincteur				Softbag		Hardbox		
Magnetisch / Magnétique				NL	NL	FR	NL/FR	
160x250mm	MAA1	5kg	JB800	1200x1200mm	J710	J720	J723	J726
160x500mm	MAA2	6kg	JB801	1200x1800mm	J711	J721	J724	J727
190x400mm	MAA3			1800x1800mm	J712	J722	J725	J728
250x320mm	MAA4							

# BRANDBESTRIJDINGSMIDDELEN EQUIPEMENTS DE LUTTE CONTRE L'INCENDIE



Ehbo/bhv kast / Armoire prem.Sec.	Ehbo/bhv kast / Armoire prem.Sec.	Ehbo/bhv kast / Armoire prem.Sec.	Ehbo/bhv kast / Armoire prem.Sec.	AED kast / Armoire DEA
60x60x25cm J2222G	60x60x25cm J2222R	115x70x25cm J3333G	115x70x25cm J3333R	38x38x20cm JAEDKAST



Luxe uitvoering  
Version luxe



Blusserkast / Coffre extincteur	Blusserkast / Coffre extincteur	Blusserkast / Coffre extincteur	Blusserkast / Coffre extincteur
6kg JBK6KG	9kg JBK9KG	9kg JBK9KGLUX	12kg JBK12KG



Staander Blusser / Support extincteur		
Met compatibele plaat / Avec support compatible		
1920mm	Zwart / Noir	J790
1920mm	Zilver / Argent	J791

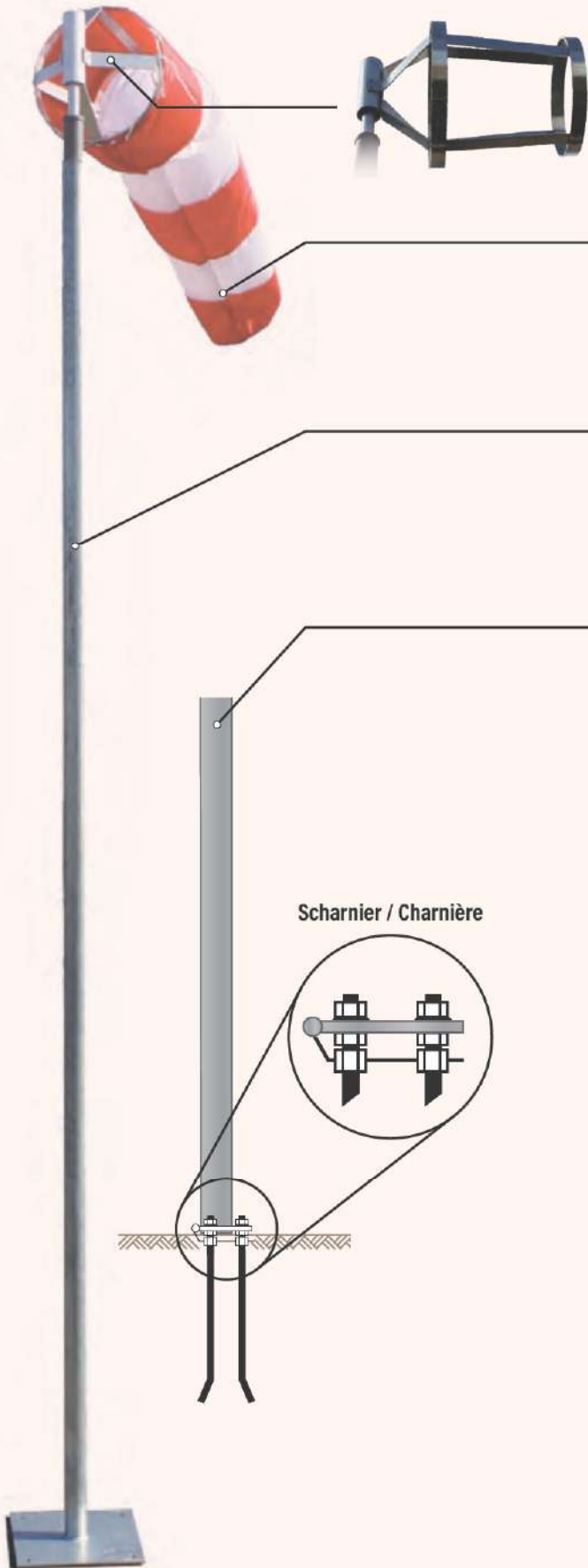

**Draaistel aluminium  
Girouette aluminium**

Voor windzak / pour manche a air	
30cm	4613.01
40cm	4614.01
60cm	4616.01

**Windzakken polyamide rood/wit  
Manches a air polyamide rouge/blanc**

Afmetingen / Dimensions	
30x150cm	4633.01
40x250cm	4634.01
60x240cm	4636.01

**Paal op voet 3m galvaniseerd staal  
Poteau 3m sur pied acier galvanisé**

Zonder 48mm-adapter, draaistel, windzak & keilbout  
Sans adaptateur-48mm, girouette, manche à air et douille

Voet / pied	
280x280x5mm	4663.01

**Kantelmast 6m - aluminium / geanodiseerd  
Mat 6m - aluminium / anodisé**

Ø 60mm - Zonder 60mm-adapter, draaistel & windzak  
Ø 60mm - Sans adaptateur-60mm, girouette & manche à air

4666.01
---------

**MAST ADAPTER kunststof  
ADAPTATEUR MAT synthétique**

Vr mast binnendiam. / pr mat diam. Int.	
48mm	4655.01
60mm	4656.01
76mm	4658.01

**Keilbout  
Douille a vis**

M10	B67001
-----	--------



Scharnier / Charnière

## REDDINGSMIDDELEN

## Manuele alarmsystemen

## EQUIPMENT SAUVETAGE

## Systèmes d'alarme manuels



**Megafoon met ingebouwde microfoon**  
Zonder sirene - Bereik 320m  
Batterijen niet inbegrepen  
**Mégaphone avec microphone intégré**  
Sans sirène - Portée 320m  
Piles non-incluses

MEG2



**Megafoon met ingebouwde microfoon**  
Met sirene - Bereik 450m  
Batterijen niet inbegrepen  
**Mégaphone avec microphone intégré**  
Avec sirène - Portée 450m  
Piles non-incluses

MEG3



**Megafoon met ingebouwde microfoon**  
Met sirene en schouderband - Bereik tot 500m  
Batterijen niet inbegrepen  
**Mégaphone avec microphone intégré**  
Avec sirène et bandoulière - Portée max. 500m  
Piles non-incluses

MEG10



**Polyamide misthoorn - 300mm - Ø80mm**  
Corne de brume en polyamide - 300mm - Ø80mm

MEG6



**Fluit tweetonig - Plastic**  
Sifflet deux tons - Plastique

MEG7



**Misthoorn 100db - Plastic**  
Corne de brume 100db - Plastique

Mini-Trump 160mm  
Trump 195mm

MEG9  
MEG8

**Signaalhoorn - onontvlambaar gas**  
Avertisseur - gaz non-inflammable

Hoorn/Avertisseur  
Navulling/Recharge

MEG4  
MEG5

**Alarmsirene - binnen / buitengebruik IP65**  
Sirène d'alarme - usage intérieur / extérieur IP65

	230V	24V
86x86x78mm	100dB	SIR1 SIR5
130x130x132mm	105dB	SIR2 SIR6
168x168x164mm	110dB	SIR3 SIR7
190x190x184mm	120dB	SIR4 SIR8

## Reddingsvesten

## Gilets de sauvetage



**100N - Met harnas en fluit**  
100N - Avec harnais et sifflet

	Oranje / Orange
S	40-50kg VES10
M	50-70kg VES11
L-XL	>70kg VES12



VES22

165N-290N

**Met fluit en harnas - automatische smeltcapsule**  
Avec sifflet et harnais - capsule de fusion automatique

	Taille	Rood / Rouge	Blauw / Bleu
165N	60-130cm	VES22	VES23
290N	60-175cm	VES32	



**Herlaadset voor reddingsvest**  
Set de recharge pour gilet de sauvetage

165N	VES4A
290N	VES4B

Andere types en kinderreddingsvesten beschikbaar op aanvraag.  
Autres modèles et gilets de sauvetage pour enfants disponible sur demande.

## Reddingsboeien

## Bouées de sauvetage



**Hoefijzerboei met afwasbare hoes**  
Bouée fer à cheval avec housse lavable

620x530x110mm

Oranje/Orange BOEI11  
Geel/Jaune BOEI13  
Wit/Blanc BOEI14



**Boei met 4 retroreflecterende strips**  
Bouée avec 4 bandes retroréfléchissantes

Ø730mm

Zonder werplijn/ Sans corde de rappel BOEI21  
Met werplijn / Avec corde de rappel 30m BOEI31



**Reddingsboeikast - gesloten model**  
Container pour bouée - modèle fermé

900x900x220mm

BOEI40

Boei niet inbegrepen  
Bouée non-incluse



**Paal voor reddingsboeikast**  
Poteau pour container pour bouée

2m

BOEI50

# VLOERMARKERINGEN

Multigrip Vinyl + Laminaat

# MARQUAGES AU SOL

Multigrip Vinyle + Laminat



700x350 61F1.01



61F1.02



61F1.03



61F1.04



700x350 61F1.21



61F1.22



61F1.23



61F1.24



700x350 61F1.41



61F1.42



61F1.43



700x350 61F1.61



61F1.62



61F1.63



61F1.64



700x350 61F1.65



838x838 61F4.01



61F4.02

# IMO SIGNS - FOTOLUMINESCEREND

# IMO SIGNS - PHOTOLUMINESCENT



VIN	VIN	VIN	VIN	VIN	VIN
150x150 7135.88	150x150 7135.01	50x50 7130.89	50x50 7130.02	50x50 7130.90	50x50 7130.91
300x300 713C.88	300x300 713C.01	150x150 7135.89	150x150 7135.02	150x150 7135.90	150x150 7135.91



VIN	VIN	VIN	VIN	VIN	VIN
50x50 7130.03	150x150 7135.92	150x150 7135.04	150x150 7135.93	150x150 7135.05	150x150 7135.94
150x150 7135.03					



VIN	VIN	VIN	VIN	VIN	VIN
150x150 7135.06	150x150 7135.21	50x50 7130.96	50x50 7130.07	50x50 7130.97	50x50 7130.08
		150x150 7135.96	150x150 7135.07	150x150 7135.97	150x150 7135.08
		300x300 713C.96	300x300 713C.07		

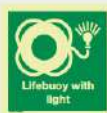

VIN	VIN	VIN	VIN	VIN	VIN
50x50 7130.98	50x50 7130.09	50x50 7130.99	50x50 7130.A0	50x50 7130.10	50x50 7130.A1
150x150 7135.98	150x150 7135.09	150x150 7135.99	150x150 7135.A0	150x150 7135.10	150x150 7135.A1



VIN	VIN	VIN	VIN	VIN	VIN
50x50 7130.44	50x50 7130.11	150x150 7135.A2	150x150 7135.12	150x150 7135.A3	150x150 7135.A4
	100x100 7131.11				
	150x150 7135.11				
	300x300 713C.11				



VIN	VIN	VIN	VIN	VIN	VIN
150x150 7135.A5	150x150 7135.13	150x150 7135.24	150x150 7135.23	100x100 7131.A8	100x100 7131.87
				150x150 7135.A8	150x150 7135.87



VIN	VIN	VIN	VIN	VIN	VIN
50x50 7130.A9	50x50 7130.14	50x50 7130.C0	50x50 7130.15	50x50 7130.C1	50x50 7130.16
150x150 7135.A9	150x150 7135.14	150x150 7135.C0	150x150 7135.15	150x150 7135.C1	150x150 7135.16



VIN	VIN	VIN	VIN	VIN	VIN
50x50 7130.C2	50x50 7130.17	50x50 7130.C3	50x50 7130.18	50x50 7130.C4	150x150 7135.C5
150x150 7135.C2	150x150 7135.17	150x150 7135.C3	150x150 7135.18	150x150 7135.C4	

IMO SIGNS - PHOTOLUMINESCENT

IMO SIGNS - FOTOLUMINESCEREND



VIN	VIN	VIN	VIN	VIN	VIN
150x150 7135.19	150x150 7135.C6	150x150 7135.22	150x150 7135.43	150x150 7135.39 200x200 7138.39	50x50 7130.25 150x150 7135.25



VIN	VIN	VIN	VIN	VIN	VIN
150x150 7135.42	150x150 7135.86	150x150 7135.38	150x150 7135.37	150x150 7135.C7 300x300 713C.C7	150x150 7135.20 300x300 713C.20



VIN	VIN	VIN	VIN	VIN	VIN
150x150 7135.C8 300x300 713C.C8	150x150 7135.28	150x200 7137.40	150x250 713F.41	100x100 7131.26 150x150 7135.26	100x100 7131.27 150x150 7135.27 200x200 7138.27



VIN	VIN	VIN	PVC	PVC
250x75 7134.45 300x150 7139.45	150x150 7135.84	150x150 7135.85	400x200 7523.84	300x150 7521.85



VIN	VIN	VIN	VIN
400x150 713A.71	400x150 713A.72	400x150 713A.65	400x150 713A.66



VIN	VIN	VIN	VIN
400x150 713A.67	400x150 713A.68	400x150 713A.79	400x150 713A.80



VIN	VIN	VIN	VIN
400x150 713A.69	400x150 713A.70	400x150 713A.77	400x150 713A.78



VIN	VIN	VIN	VIN
400x150 713A.73	400x150 713A.74	400x150 713A.75	400x150 713A.76

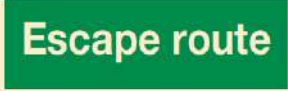

VIN	VIN	VIN
400x150 713A.81	400x150 713A.82	400x150 713A.83

# IMO SIGNS - FOTOLUMINESCEREND

# IMO SIGNS - PHOTOLUMINESCENT



VIN		VIN		VIN		VIN		VIN	
75x150	7133.0	75x150	7133.28	75x150	7133.29	75x150	7133.30	75x150	7133.31
150x300	7139.0	150x300	7139.28	150x300	7139.29	150x300	7139.30	150x300	7139.31



VIN		VIN		VIN		VIN		VIN	
75x150	7133.32	75x150	7133.33	75x150	7133.34	75x150	7133.35	75x150	7133.36
150x300	7139.32	150x300	7139.33	150x300	7139.34	150x300	7139.35	150x300	7139.36



VIN		VIN		VIN		VIN		VIN	
75x150	7133.A	75x150	7133.B	75x150	7133.C	75x150	7133.D	75x150	7133.E
150x300	7139.A	150x300	7139.B	150x300	7139.C	150x300	7139.D	150x300	7139.E



VIN		VIN		VIN		VIN	
300x100	7136.46	300x100	7136.48	300x100	7136.47	300x100	7136.53



VIN		VIN		VIN		VIN	
300x100	7136.51	300x100	7136.52	300x100	7136.57	300x100	7136.54



VIN		VIN		VIN		VIN	
300x100	7136.55	300x100	7136.62	300x100	7136.63	300x100	7136.64



VIN		VIN		VIN		VIN	
300x100	7136.58	300x100	7136.50	300x100	7136.59	300x100	7136.49



VIN	
300x100	7136.56

# IMO SIGNS - FOTOLUMINESCEREND

# IMO SIGNS - PHOTOLUMINESCENT



FASTEN SEAT BELTS



SECURE HATCHES



START ENGINE



LOWER LIFEBOAT



LOWER LIFERAFT



LOWER RESCUE BOAT

VIN	VIN	VIN	VIN	VIN	VIN
150x150 7335.01	150x150 7335.02	150x150 7335.03	150x150 7335.04	150x150 7335.05	150x150 7335.06



RELEASE FALLS



START WATER SPRAY



START AIR SUPPLY



RELEASE GRIPES



This hatch must be kept closed at sea



This door must be kept closed at sea

VIN	VIN	VIN	VIN	VIN	VIN
150x150 7335.07	150x150 7335.08	150x150 7335.09	150x150 7335.10	150x150 7335.11	150x150 7335.12



Fire door keep closed



Fire door keep shut



Fire escape keep clear



VIN	VIN	VIN	VIN	VIN
150x150 7335.13	150x150 7335.14	150x150 7335.15	150x150 7335.16	150x150 7335.17



# IMO SIGNS - FOTOLUMINESCEREND

# IMO SIGNS - PHOTOLUMINESCENT



VIN		VIN		VIN		VIN		VIN	
100x100	7231.01	50x50	7230.02	100x100	7231.03	100x100	7231.04	100x100	7231.05
150x150	7235.01	100x100	7231.02	150x150	7235.03	150x150	7235.04	150x150	7235.05
		150x150	7235.02						



VIN		VIN		VIN		VIN		VIN	
300x150	3043.62	300x150	3043.63	300x150	3043.K2	300x150	3043.E3	300x150	3043.B2
400x200	3045.62	400x200	3045.63	400x200	3045.K2	400x200	3045.E3	400x200	3045.B2



VIN		VIN		VIN		VIN		VIN	
100x200	7232.42	100x200	7232.43	100x200	7232.44	100x200	7232.45	100x200	7232.46



VIN		VIN		VIN		VIN		VIN	
300x100	7236.11	300x100	7236.48	300x100	7236.49	300x100	7236.50	300x100	7236.27



VIN		VIN		VIN		VIN		VIN	
300x100	7236.16	300x100	7236.17	300x100	7236.12	300x100	7236.13	300x100	7236.14



VIN		VIN		VIN		VIN		VIN	
300x100	7236.24	300x100	7236.23	300x100	7236.25	300x100	7236.21	300x100	7236.18



VIN		VIN		VIN		VIN		VIN	
300x100	7236.30	300x100	7236.26	300x100	7236.28	300x100	7236.20	300x100	7236.22



VIN		VIN		VIN		VIN		VIN	
100x100	7231.0	100x100	7231.31	100x100	7231.32	100x100	7231.33	100x100	7231.35
150x150	7235.0	150x150	7235.31	150x150	7235.32	150x150	7235.33	150x150	7235.35



VIN		VIN		VIN		VIN		VIN	
100x100	7231.36	100x100	7231.37	100x100	7231.38	100x100	7231.39	100x100	7231.41
150x150	7235.36	150x150	7235.37	150x150	7235.38	150x150	7235.39	150x150	7235.41
								200x200	7238.40
								200x200	7238.41

IMO SIGNS - PHOTOLUMINESCENT

IMO SIGNS - FOTOLUMINESCEREND

# IMO SIGNS - FOTOLUMINESCEREND

# IMO SIGNS - PHOTOLUMINESCENT

Fire control plan VIN	Safety plan VIN	Fire alarm - Push Button / Switch VIN	Fire alarm - Bell VIN	Automatic fire alarm VIN	Fire alarm - Horn VIN	CO2 - Horn VIN
50x50 7430.01 150x150 7435.01	150x150 7435.84	150x150 7435.02	150x150 7435.04	150x150 7435.06	150x150 7435.03	150x150 7435.08
Sprinkler horn VIN	Halon horn VIN	Control station VIN	Fire station VIN	Fire blanket VIN	Locker + Fireman's outfit VIN	Fire fighter's outfit locker VIN
150x150 7435.46	150x150 7435.12	150x150 7435.66	150x150 7435.30	150x150 7435.J2	50x50 7430.67 150x150 7435.67	150x150 7435.10
Inert gas installation VIN	Powder fire extinguisher VIN	Powder fire extinguisher VIN	Powder fire extinguisher VIN	Powder fire extinguisher VIN	Powder fire extinguisher VIN	CO2 fire extinguisher VIN
150x150 7435.70	150x150 7435.76	150x150 7435.81	150x150 7435.80	150x150 7435.J3	150x150 7435.J4	150x150 7435.79
CO2 fire extinguisher VIN	Foam fire extinguisher VIN	Foam fire extinguisher VIN	CO2 fire extinguisher VIN	Wheeled CO2 fire extinguisher VIN		
150x150 7435.J5	150x150 7435.77	150x150 7435.J6	150x150 7435.G9	150x150 7435.83		
Wheeled powder fire extinguisher VIN	Wheeled foam fire extinguisher VIN	Gas other than CO2 or N fire extinguisher VIN	Foam fire extinguisher VIN	Powder fire extinguisher VIN	Water fire extinguisher VIN	Wheeled CO2 fire extinguisher VIN
150x150 7435.82 200x200 7438.82	150x150 7435.J7	150x150 7435.H0	150x150 7435.H1	150x150 7435.H2	150x150 7435.H3	150x150 7435.H4
Gas other than CO2 or N wheeled fire extinguisher VIN	Wheeled foam fire extinguisher VIN	Wheeled powder fire extinguisher VIN	Wheeled water fire extinguisher VIN	Fire extinguisher spare charges VIN	Foam monitor VIN	Powder monitor VIN
150x150 7435.H5	150x150 7435.H6	150x150 7435.H7	150x150 7435.H8	150x150 7435.89	150x150 7435.G3	150x150 7435.G4
Water monitor VIN	Water monitor (Gun) VIN	Foam monitor (Gun) VIN	Powder monitor (Gun) VIN	Flame detector VIN	Smoke detector VIN	Gas detector VIN
150x150 7435.G5	150x150 7435.23	150x150 7435.14	150x150 7435.52	150x150 7435.55	150x150 7435.56	150x150 7435.62
Heat detector VIN	Powder hose + Hand gun VIN	Foam fire hose + nozzle VIN	Powder fire hose + nozzle VIN	Water fire hose + nozzle VIN	Foam nozzle VIN	Foam valve VIN
150x150 7435.61	150x150 7435.53	150x150 7435.G6	150x150 7435.G7	150x150 7435.G8	150x150 7435.15	150x150 7435.17

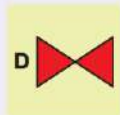

Section valves drenching  
VIN  
150x150 7435.29



Sprinkler section valve  
VIN  
150x150 7435.47



Fire main with valves  
VIN  
150x150 7435.57

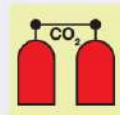

CO2 release station  
VIN  
50x50 7430.09  
150x150 7435.09

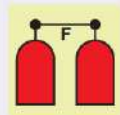

Foam release station  
VIN  
150x150 7435.18

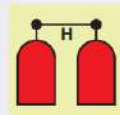

Halon release station  
VIN  
150x150 7435.49

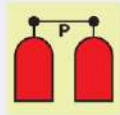

Powder release station  
VIN  
150x150 7435.54



Emergency telephone station  
VIN  
150x150 7435.25



Foam installation  
VIN  
150x150 7435.13



Sprinkler installation  
VIN  
150x150 7435.44

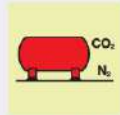

CO2/Nitrogen bulk installation  
VIN  
150x150 7435.72

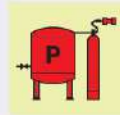

Powder installation  
VIN  
150x150 7435.51



Drenching installation  
VIN  
150x150 7435.27



Halon 1301 bottles in a protected area  
VIN  
150x150 7435.50



Portable foam applicator unit  
VIN  
150x150 7435.H9



Portable foam applicator  
VIN  
150x150 7435.36

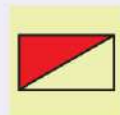

Fire alarm panel  
VIN  
150x150 7435.43

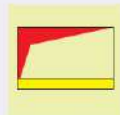

High expansion foam supply trunk  
VIN  
150x150 7435.71



Bilge pump  
VIN  
150x150 7435.21



Emergency bilge pump  
VIN  
150x150 7435.22

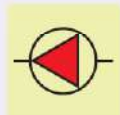

Fire pump  
VIN  
150x150 7435.60



Emergency Fire pump  
VIN  
150x150 7435.19



Space protected by sprinkler  
VIN  
150x150 7435.45



Manually operated call point  
VIN  
150x150 7435.05

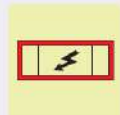

Emergency switchboard  
VIN  
150x150 7435.74



Space protected by fire detector(s)  
VIN  
150x150 7435.J1



Breathing device air compressor  
VIN  
150x150 7435.19



Fire axe  
VIN  
150x150 7435.26



Locker - additional protective clothing  
VIN  
150x150 7435.68



Space protected by foam  
VIN  
150x150 7435.16



Water fog applicator  
VIN  
150x150 7435.24

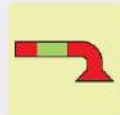

Water fog applicator  
VIN  
150x150 7435.18



Hose box with spray / jet  
VIN  
150x150 7435.58

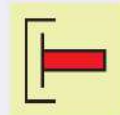

International shore connection  
VIN  
50x50 7430.59  
150x150 7435.59



Main vertical zone  
VIN  
150x150 7435.42



Main vertical zone division  
VIN  
150x150 7435.90



'A' class division  
VIN  
150x150 7435.31



'A' class fire door  
VIN  
150x150 7435.32



'A' class fire door self closing  
VIN  
150x150 7435.33



'A' class sliding fire door  
VIN  
150x150 7435.34

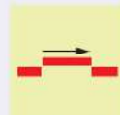

'A' class sliding fire door self closing  
VIN  
150x150 7435.35



'A' class watertight fire door  
VIN  
150x150 7435.91



'A' class semi-watertight fire door  
VIN  
150x150 7435.92



'A' class self closing watertight fire door  
VIN  
150x150 7435.95



'A' class self closing semi-watertight fire door  
VIN  
150x150 7435.96



'A' class watertight sliding fire door  
VIN  
150x150 7435.99



'A' class semi-watertight sliding fire door  
VIN  
150x150 7435.A0

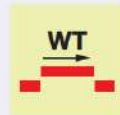

'A' class self closing watertight sliding fire door  
VIN  
150x150 7435.A3



'A' class self closing semi-watertight sliding fire door  
VIN  
150x150 7435.A4

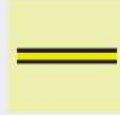

'B' class division  
VIN  
150x150 7435.37



'B' class fire door  
VIN  
150x150 7435.38



'B' class self closing fire door  
VIN  
150x150 7435.39

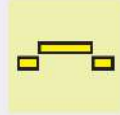

'B' class sliding fire door  
VIN  
150x150 7435.40

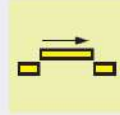

'B' class self closing sliding fire door  
VIN  
150x150 7435.41



'B' class watertight fire door  
VIN  
150x150 7435.93

# IMO SIGNS - FOTOLUMINESCEREND

# IMO SIGNS - PHOTOLUMINESCENT

"B" class semi-watertight fire door	"B" class self closing watertight fire door	"B" class self closing semi-watertight fire door	"B" class watertight sliding fire door	"B" class semi-watertight sliding fire door	"B" class self closing watertight sliding fire door	"B" class self closing semi-watertight sliding fire door
VIN	VIN	VIN	VIN	VIN	VIN	VIN
150x150 7435.94	150x150 7435.97	150x150 7435.98	150x150 7435.A1	150x150 7435.A2	150x150 7435.A5	150x150 7435.A6

Emergency generator	Emergency batteries	CO2 battery	Halon 1301 battery	Fixed CO2 extinguishing battery	Fixed nitrogen extinguishing battery	Fixed gas other than CO2 or N extinguishing battery
VIN	VIN	VIN	VIN	VIN	VIN	VIN
150x150 7435.73	150x150 7435.J0	150x150 7435.48	150x150 7435.10	150x150 7435.F1	150x150 7435.F2	150x150 7435.F3

Fixed foam extinguishing battery	Fixed powder extinguishing battery	Fixed water extinguishing battery	Fire hydrant	Foam section valve	Powder section valve	Fire main section valve
VIN	VIN	VIN	VIN	VIN	VIN	VIN
150x150 7435.F4	150x150 7435.F5	150x150 7435.F6	150x150 7435.E0	150x150 7435.E1	150x150 7435.E2	150x150 7435.E3

Sprinkler section valve	Fixed water extinguishing installation	Fixed CO2 extinguishing installation	Fixed nitrogen extinguishing installation	Fixed Halon equivalent extinguishing installation	Fixed foam extinguishing installation	Fixed powder extinguishing installation
VIN	VIN	VIN	VIN	VIN	VIN	VIN
150x150 7435.E4	150x150 7435.F0	150x150 7435.E5	150x150 7435.E6	150x150 7435.E7	150x150 7435.E8	150x150 7435.E9

Fixed CO2 ext. bottle in protected area	Fixed nitrogen ext. bottle in protected area	Fixed gas not CO2 or N ext. bottle in protected area	Fixed foam ext. bottle in protected area	Fixed powder ext. bottle in protected area	Fixed water ext. bottle in protected area	Space protected by CO2
VIN	VIN	VIN	VIN	VIN	VIN	VIN
150x150 7435.F7	150x150 7435.F8	150x150 7435.F9	150x150 7435.G0	150x150 7435.G1	150x150 7435.G2	50x50 7430.07 150x150 7435.07

Space protected by halon 1301	Space protected by drenching system	Space protected by CO2 ext. system	Space protected by nitrogen fire ext. system	Space protected by gas not CO2 or N ext. system	Space protected by foam ext. system	Space protected by powder ext. system
VIN	VIN	VIN	VIN	VIN	VIN	VIN
150x150 7435.11	150x150 7435.28	150x150 7435.11	150x150 7435.12	150x150 7435.13	150x150 7435.14	150x150 7435.15

Space protected by water ext. system	Space protected by sprinkler system	Primary means of escape	Secondary means of escape	Closing appliance exterior ventilation	Remote controlled fuel / lub oil valves	Remote controlled fire pump or switches
VIN	VIN	VIN	VIN	VIN	VIN	VIN
150x150 7435.16	150x150 7435.17	150x150 7435.86	150x150 7435.87	150x150 7435.69	150x150 7435.65	150x150 7435.20

Fire damper in vent duct	Fire damper for accom. and service spaces	Fire damper for machinery spaces	Fire damper for cargo spaces	Remote controlled skylights	Skylight remote control	Remote ventilation shut off
VIN	VIN	VIN	VIN	VIN	VIN	VIN
150x150 7435.63	150x150 7435.B3	150x150 7435.B4	150x150 7435.B5	150x150 7435.64	150x150 7435.B0	150x150 7435.75

IMO SIGNS - PHOTOLUMINESCENT

IMO SIGNS - FOTOLUMINESCEREND

# IMO SIGNS - FOTOLUMINESCEREND

# IMO SIGNS - PHOTOLUMINESCENT

IMO SIGNS - PHOTOLUMINESCENT

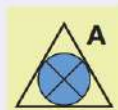

Remote ventilation shut-off for accommodation  
VIN  
150x150 7435.A7

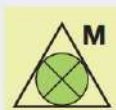

Remote ventilation shut-off for machinery spaces  
VIN  
150x150 7435.A8



Remote ventilation shut-off for cargo spaces  
VIN  
150x150 7435.A9



Watertight doors remote control  
VIN  
150x150 7435.B1



Fire doors remote control  
VIN  
150x150 7435.B2

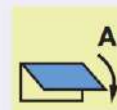

Closing device for accommodation ventilation  
VIN  
150x150 7435.B6



Closing device for machinery spaces ventilation  
VIN  
150x150 7435.B7

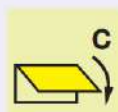

Closing device for cargo spaces ventilation  
VIN  
150x150 7435.B8

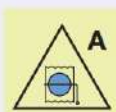

Remote control accommodation fire dampers  
VIN  
150x150 7435.B9

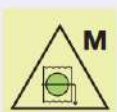

Remote control machinery space fire dampers  
VIN  
150x150 7435.C0

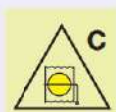

Remote control cargo space fire dampers  
VIN  
150x150 7435.C1



Remote control accom. closing devices  
VIN  
150x150 7435.C2



Remote control machinery space closing devices  
VIN  
150x150 7435.C3



Remote control cargo space closing devices  
VIN  
150x150 7435.C4



Remote control for fire pump  
VIN  
150x150 7435.C5



Remote control emergency fire pump  
VIN  
150x150 7435.C6



Fuel pumps remote shut-off  
VIN  
150x150 7435.C7



Lub oil pumps remote shut-off  
VIN  
150x150 7435.C8



Bilge pump remote control  
VIN  
150x150 7435.C9



Emergency bilge pump remote control  
VIN  
150x150 7435.D0



Fuel oil valves remote control  
VIN  
150x150 7435.D1



Lub oil valves remote control  
VIN  
150x150 7435.D2



Fire pump valves remote control  
VIN  
150x150 7435.D3

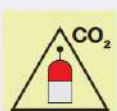

Remote release station CO2  
VIN  
150x150 7435.D4



Remote release station nitrogen  
VIN  
150x150 7435.D5

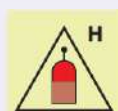

Remote release station halon equivalent  
VIN  
150x150 7435.D6

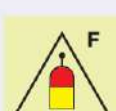

Remote release station foam  
VIN  
150x150 7435.D7

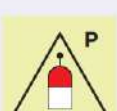

Remote release station powder  
VIN  
150x150 7435.D8

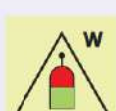

Remote release station water  
VIN  
150x150 7435.D9

IMO SIGNS - FOTOLUMINESCEREND

VIN														
8x8	IMO 001	8x	8x	8x	8x	16x	8x	8x	8x	8x	8x	16x	48x	
VIN														
8x8	IMO 002	8x	8x	64x	16x	64x								
VIN														
8x8	IMO 003	8x	24x	24x	8x	16x	16x	32x	8x	8x	8x	8x	8x	8x
VIN														
8x8	IMO 004	56x	8x	8x	56x	16x	16x							
VIN														
8x8	IMO 005	8x	48x	16x	8x	8x	8x	48x	8x	8x	8x	8x		
VIN														
8x8	IMO 006	8x	8x	8x	16x	8x	16x	8x	40x	16x	24x			
VIN														
8x8	IMO 007	Fire Plan 10x	24x	8x	24x	8x	48x	24x	8x					
VIN														
8x8	IMO 008	48x	16x	8x	8x	48x	16x	8x	8x	8x				
VIN														
8x8	IMO 009	24x	16x	16x	8x	8x	8x	16x	32x	16x	16x			

## SNAPLIGHT - SIGNALEER UZELF

De Cyalume® originele scheikundige lichten zijn waterdichte en niet-toxische breeklichten die meerdere uren steunlicht kunnen bezorgen, in geval van panne, allerhande noodtoestanden, op feesten, concerten, sportevenementen. De lichtsticks garanderen licht zonder batterijen of kabels.

Alles wat u hoeft te doen is ze te buigen en schudden.



## SNAPLIGHT - SIGNALEZ-VOUS

Les lumières chimiques Cyalume® originales sont des bâtons lumineux étanches et non toxiques qui fournissent plusieurs heures de lumière d'appoint en cas de panne ou pour toutes les situations d'urgence, fêtes, concerts, événements sportifs. Ils vous garantissent de la lumière sans batteries ou câbles. Il suffit de les plier et de les secouer.

						Wit Blanc
5min.H.I.						9822.09
30min.H.I.		9822.07	9822.08			
8u/h.					9822.05	9822.06
12u/h.	9822.01	9822.02	9822.03	9822.04		

# SCHEEPVAART & OFFSHORE MARKERING BUISLEIDINGEN OP ROL

# MARITIMES & OFFSHORE MARQUAGE DE TUYAUTERIES EN ROULEAU

ISO 14726 / ISO (DIS) 14726-2  
Materiaal: MMT Zeewatervast

Materiel: MMT Résistant à l'eau de mer

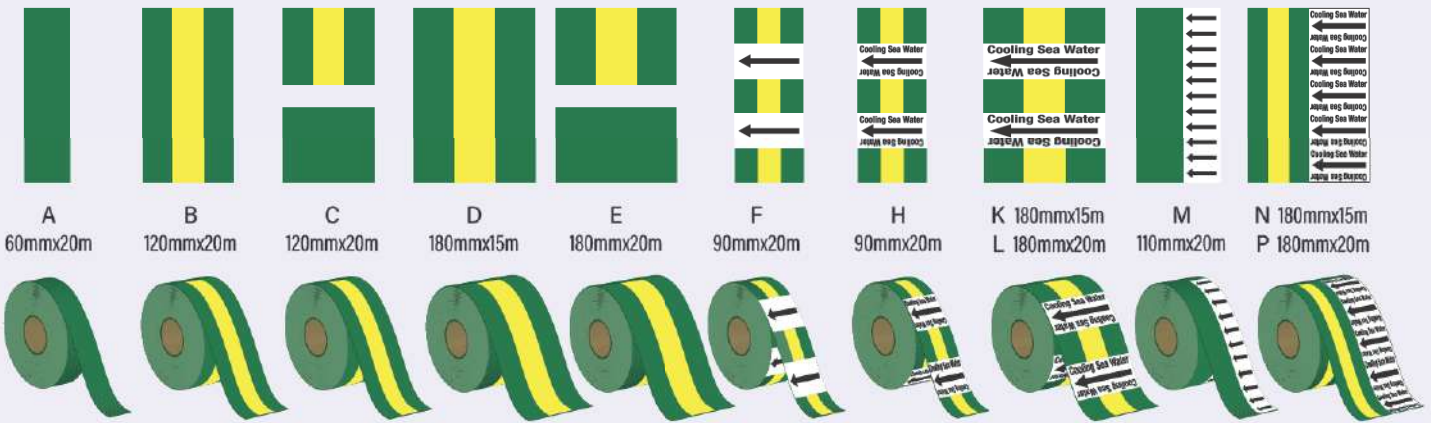

	A	B	C	D	E	F	H	K	L	M	N	P
Sea water	19S1.01		19S3.01		19S5.01					19P6.01		
Sanitary sea water		19S2.02	19S3.02	19S4.02	19S5.02	19P2.02	19P3.02	19P4.02	19P5.02	19P6.02	19P7.02	19P8.02
Cooling sea water		19S2.03	19S3.03	19S4.03	19S5.03	19P2.03	19P3.03	19P4.03	19P5.03	19P6.03	19P7.03	19P8.03
Ballast water		19S2.04	19S3.04	19S4.04	19S5.04	19P2.04	19P3.04	19P4.04	19P5.04	19P6.04	19P7.04	19P8.04
Decontamination water		19S2.63	19S3.63	19S4.63	19S5.63	19P2.63	19P3.63	19P4.63	19P5.63	19P6.63	19P7.63	19P8.63
Fresh water	19S1.05		19S3.05		19S5.05					19P6.05		
Distillate		19S2.06	19S3.06	19S4.06	19S5.06	19P2.06	19P3.06	19P4.06	19P5.06	19P6.06	19P7.06	19P8.06
Condensate		19S2.07	19S3.07	19S4.07	19S5.07	19P2.07	19P3.07	19P4.07	19P5.07	19P6.07	19P7.07	19P8.07
Potable water		19S2.08	19S3.08	19S4.08	19S5.08	19P2.08	19P3.08	19P4.08	19P5.08	19P6.08	19P7.08	19P8.08
Condensate from heating system		19S2.09	19S3.09	19S4.09	19S5.09	19P2.09	19P3.09	19P4.09	19P5.09	19P6.09	19P7.09	19P8.09
Fresh water, sanitary		19S2.10	19S3.10	19S4.10	19S5.10	19P2.10	19P3.10	19P4.10	19P5.10	19P6.10	19P7.10	19P8.10
Cooling fresh water		19S2.11	19S3.11	19S4.11	19S5.11	19P2.11	19P3.11	19P4.11	19P5.11	19P6.11	19P7.11	19P8.11
Feed water		19S2.12	19S3.12	19S4.12	19S5.12	19P2.12	19P3.12	19P4.12	19P5.12	19P6.12	19P7.12	19P8.12
Chilled water		19S2.13	19S3.13	19S4.13	19S5.13	19P2.13	19P3.13	19P4.13	19P5.13	19P6.13	19P7.13	19P8.13
Fuel	19S1.14		19S3.14		19S5.14					19P6.14		
Diesel fuel (MDO)		19S2.15	19S3.15	19S4.15	19S5.15	19P2.15	19P3.15	19P4.15	19P5.15	19P6.15	19P7.15	19P8.15
Heavy fuel		19S2.18	19S3.18	19S4.18	19S5.18	19P2.18	19P3.18	19P4.18	19P5.18	19P6.18	19P7.18	19P8.18
Waste media	19S1.19		19S3.19		19S5.19			19P4.19	19P5.19		19P7.19	19P8.19
Black water		19S2.20	19S3.20	19S4.20	19S5.20	19P2.20	19P3.20	19P4.20	19P5.20	19P6.20	19P7.20	19P8.20
Sewage		19S2.21	19S3.21	19S4.21	19S5.21	19P2.21	19P3.21	19P4.21	19P5.21	19P6.21	19P7.21	19P8.21
Waste oil / Used oil		19S2.22	19S3.22	19S4.22	19S5.22	19P2.22	19P3.22	19P4.22	19P5.22	19P6.22	19P7.22	19P8.22
Exhaust gas		19S2.23	19S3.23	19S4.23	19S5.23	19P2.23	19P3.23	19P4.23	19P5.23	19P6.23	19P7.23	19P8.23
Bilge water		19S2.24	19S3.24	19S4.24	19S5.24	19P2.24	19P3.24	19P4.24	19P5.24	19P6.24	19P7.24	19P8.24



Buismarkeringen op Scotch drager of aluminium MMT. Gelamineerd tegen UV-straling en chemische invloeden. Voor elk type buisleiding en bestand tegen temperaturen van -40°C tot +90°C. Conform ISO 14726 / ISO (DIS) 14726-2.

Tuyauteries sur feuille de base Scotch ou aluminium MMT. Laminé contre rayons UV et influences chimiques. Pour chaque type de tuyau et résistant aux températures de -40°C à 90°C. Conform ISO 14726 / ISO (DIS) 14726-2.

# SCHEEPVAART & OFFSHORE MARKERING BUISLEIDINGEN OP ROL

# MARITIMES & OFFSHORE MARQUAGE DE TUYAUTERIES EN ROULEAU

ISO 14726 / ISO (DIS) 14726-2  
Materiaal: MMT Zeewatervast

Materiel: MMT Résistant à l'eau de mer

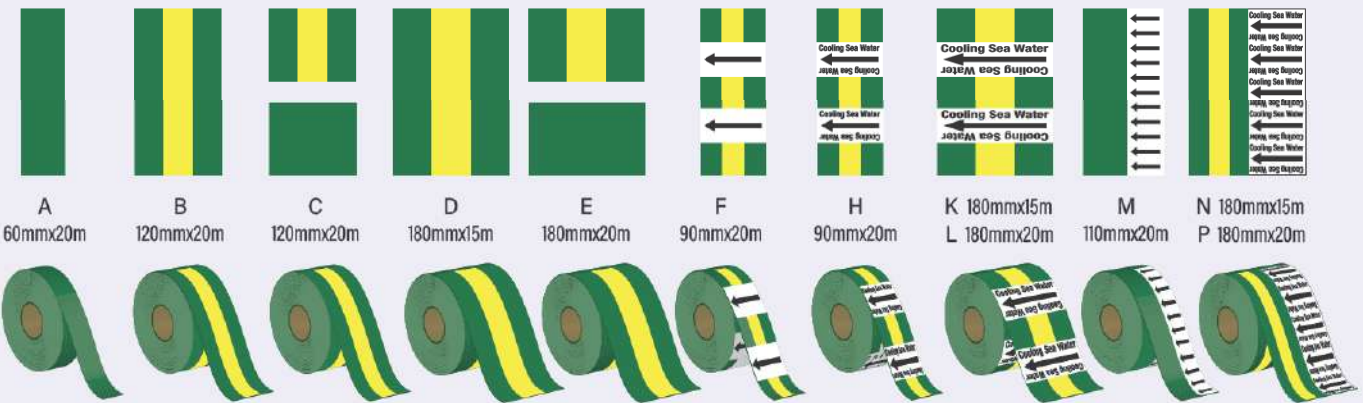

	A	B	C	D	E	F	H	K	L	M	N	P
Acids, Alkalis	19S1.25	19S3.25			19S5.25					19P6.25		
Non-flammable gases	19S1.26	19S3.26			19S5.26					19P6.26		
Nitrogen		19S2.27	19S3.27	19S4.27	19S5.27	19P2.27	19P3.27	19P4.27	19P5.27	19P6.27	19P7.27	19P8.27
Oxygen		19S2.28	19S3.28	19S4.28	19S5.28	19P2.28	19P3.28	19P4.28	19P5.28	19P6.28	19P7.28	19P8.28
Breathing gas		19S2.29	19S3.29	19S4.29	19S5.29	19P2.29	19P3.29	19P4.29	19P5.29	19P6.29	19P7.29	19P8.29
Refrigerant		19S2.30	19S3.30	19S4.30	19S5.30	19P2.30	19P3.30	19P4.30	19P5.30	19P6.30	19P7.30	19P8.30
Compressed air HP		19S2.31	19S3.31	19S4.31	19S5.31	19P2.31	19P3.31	19P4.31	19P5.31	19P6.31	19P7.31	19P8.31
Breathing air		19S2.32	19S3.32	19S4.32	19S5.32	19P2.32	19P3.32	19P4.32	19P5.32	19P6.32	19P7.32	19P8.32
Oil other than fuel	19S1.33	19S3.33			19S5.33					19P6.33		
Thermal fluid		19S2.34	19S3.34	19S4.34	19S5.34	19P2.34	19P3.34	19P4.34	19P5.34	19P6.34	19P7.34	19P8.34
Lubrication oil for gas turbines		19S2.36	19S3.36	19S4.36	19S5.36	19P2.36	19P3.36	19P4.36	19P5.36	19P6.36	19P7.36	19P8.36
Hydraulic fluid		19S2.37	19S3.37	19S4.37	19S5.37	19P2.37	19P3.37	19P4.37	19P5.37	19P6.37	19P7.37	19P8.37
Fire-fighting	19S1.39	19S3.39			19S5.39					19P6.39		
Fire-fighting water		19S2.40	19S3.40	19S4.40	19S5.40	19P2.40	19P3.40	19P4.40	19P5.40	19P6.40	19P7.40	19P8.40
Sprinkler water		19S2.42	19S3.42	19S4.42	19S5.42	19P2.42	19P3.42	19P4.42	19P5.42	19P6.42	19P7.42	19P8.42
Fire-fighting gas		19S2.43	19S3.43	19S4.43	19S5.43	19P2.43	19P3.43	19P4.43	19P5.43	19P6.43	19P7.43	19P8.43
Fire-fighting foam		19S2.44	19S3.44	19S4.44	19S5.44	19P2.44	19P3.44	19P4.44	19P5.44	19P6.44	19P7.44	19P8.44
Fire-fighting powder		19S2.45	19S3.45	19S4.45	19S5.45	19P2.45	19P3.45	19P4.45	19P5.45	19P6.45	19P7.45	19P8.45
Flammable gases	19S1.46	19S3.46	19S4.46	19S5.46	19P2.46	19P3.46	19P4.46	19P5.46	19P6.46	19P7.46	19P8.46	
Liquid gas		19S2.47	19S3.47	19S4.47	19S5.47	19P2.47	19P3.47	19P4.47	19P5.47	19P6.47	19P7.47	19P8.47
Hydrogen		19S2.48	19S3.48	19S4.48	19S5.48	19P2.48	19P3.48	19P4.48	19P5.48	19P6.48	19P7.48	19P8.48
Acetylene		19S2.49	19S3.49	19S4.49	19S5.49	19P2.49	19P3.49	19P4.49	19P5.49	19P6.49	19P7.49	19P8.49
Masses (dry and wet)	19S1.50	19S3.50			19S5.50					19P6.50		
Steam	19S1.51	19S3.51			19S5.51					19P6.51		
Supply steam		19S2.54	19S3.54	19S4.54	19S5.54	19P2.54	19P3.54	19P4.54	19P5.54	19P6.54	19P7.54	19P8.54
Steam for heating purposes		19S2.56	19S3.56	19S4.56	19S5.56	19P2.56	19P3.56	19P4.56	19P5.56	19P6.56	19P7.56	19P8.56
Exhaust steam		19S2.57	19S3.57	19S4.57	19S5.57	19P2.57	19P3.57	19P4.57	19P5.57	19P6.57	19P7.57	19P8.57
Air in ventilation systems	19S1.58	19S3.58			19S5.58					19P6.58		
Natural exhaust air		19S2.59	19S3.59	19S4.59	19S5.59	19P2.59	19P3.59	19P4.59	19P5.59	19P6.59	19P7.59	19P8.59
Atmospheric air		19S2.61	19S3.61	19S4.61	19S5.61	19P2.61	19P3.61	19P4.61	19P5.61	19P6.61	19P7.61	19P8.61
Natural supply air		19S2.62	19S3.62	19S4.62	19S5.62	19P2.62	19P3.62	19P4.62	19P5.62	19P6.62	19P7.62	19P8.62

Andere formaten en materialen op aanvraag.

Autres formats et matériaux sur demande.

# VERBODSTEKENS ISO 7010

# SIGNAUX D'INTERDICTION ISO 7010



Haaks - R/V  
En drapeau - R/V

PP	VIN.	Greenline	Raamsticker Adhésif vitre	FOREX 5mm	FOREX R/V 5mm	SIGNICOLOR 1,5mm	PVC R/V 1mm	PVC 1mm
Ø 30mm	3220.P0	3230.P0					120x120	3228.P0
Ø 50mm	3221.P0	3231.P0	32A0.P0	32E9.P0	32G9.P0			200x200
Ø 90mm	3222.P0	3232.P0	32A1.P0					3272.P0
Ø 150mm	3223.P0	3233.P0	32AA.P0					
Ø 200mm	3224.P0	3234.P0	32A2.P0			3212.P0		
Ø 300mm	3225.P0	3235.P0	32A3.P0			3213.P0		
Ø 400mm	3226.P0	3236.P0				3214.P0		
Ø 500mm	3227.P0	3237.P0						
Ø 600mm	3228.P0	3238.P0						
Ø 650mm	3229.P0	3239.P0						
Ø 800mm								



Alu anod. 1,5mm Alu anod. 1,5mm	Alu anod. 1,5mm - Haaks Alu anod. 1,5mm - En drapeau	Alu anod. - Zwarte eindkappen Alu anod. - Finition noire	Alu anod. - Zwarte eindkappen - Hangend Alu anod. - Finition noire - Suspendu
Plat	Plat R/V	Prof.	Prof. R/V
125x125 150x150	321B.P0 321A.P0	150x150 3211.P0	125x125 32PB.P0 150x150 32PA.P0



Plexi 6mm Plexi 6mm	Plexi 6mm - Zijwaarts Plexi 6mm - Latéral	Plexi 6mm - Hangend Plexi 6mm - Suspendu	PP	VIN.	PP	VIN.			
Muur/Mur	R/V	R/V							
150x150 200x200	5141.60 5142.60	150x150 200x200	5241.60 5242.60	150x150 200x200	5441.60 5442.60	90mm 200mm 300mm	3231.AJ 3232.AJ 3223.AJ	90mm 200mm 300mm	3231.AK 3232.AK 3223.AK



PP	VIN.	PP	VIN.	Raamsticker Adhésif vitre	PP	VIN.	PP	PP	
140x200 210x300 300x420	3222.X0 3224.X0 3225.X0	3232.X0 3234.X0 3235.X0	140x200 210x300 300x420	3222.X1 3232.X1 32A2.X1	140x200 210x300 300x420	3222.X2 3224.X2 3225.X2	3232.X2 3234.X2 3235.X2	300x420 300x420	3225.X4 3225.X3



PP	VIN.	PP	VIN.
300x100	3223.X5 3233.X5	300x100	3223.X6 3233.X6



SIGNAUX D'INTERDICTION - ISO 7010

VERBODSTEKENS - ISO 7010

# VERBODSTEKENS ISO 7010

# SIGNAUX D'INTERDICTION ISO 7010



PP	VIN.	VIN REFL	Greenline	Raamsticker Adhésif vitre	FOREX 5mm	SIGNICOLOR 1,5mm
Ø 50mm	3230.02					
Ø 90mm	3221.02	3231.02		32A1.02		
Ø 150mm	322A.02	323A.02	32RA.02			
Ø 200mm	3222.02	3232.02	32R2.02	32U2.02	32A2.02	3212.02
Ø 300mm	3223.02	3233.02				3213.02
Ø 400mm	3224.02	3234.02				3214.02
□ 800mm					32E9.02	



Alu anod.



Plexi 6mm  
bevestiging inbegr. / fixations incl.

Plat	Prof.	Muur / Mur	Zijw./V / Lat./V
125x125mm	321B.02	32PB.02	150x150mm 5141.58 5241.58
150x150mm	321A.02	32PA.02	200x200mm 5142.58 5242.58



VIN.	PP
90mm	3231.S2
200mm	3232.S2
400mm	3224.S2



VIN.	PP
90mm	3231.P7



VIN.	PP
90mm	3231.P8
200mm	3232.P8



VIN.	PP
90mm	3231.P9



PP	VIN.
90mm	3231.P3
200mm	3222.P3
	3232.P3



PP	VIN.
90mm	3221.N0
200mm	3222.N0



PP	VIN.
90mm	3221.BC
200mm	3222.BC



PP	VIN.
50mm	3230.14
90mm	3221.14
200mm	3222.14
300mm	3223.14
400mm	3224.14



PP	VIN.
50mm	3230.W1
90mm	3221.W1
200mm	3222.W1



PP	VIN.
90mm	3221.S5
200mm	3222.S5



PP	VIN.
50mm	3230.35
90mm	3221.35
150mm	322A.35
200mm	3222.35
300mm	3223.35



PP	VIN.
90mm	3231.89
200mm	3222.89



PP	VIN.
90mm	3221.93
200mm	3222.93



PP	VIN.
50mm	3230.A1
200mm	3222.A1



PP	VIN.
200mm	3232.N3
300mm	3223.N3



PP	VIN.
50mm	3230.BB
90mm	3221.BB
200mm	3222.BB



PP	VIN.
50mm	3230.S6
90mm	3221.S6
200mm	3222.S6



PP	VIN.
90mm	3221.N1
200mm	3222.N1



PP	VIN.
50mm	3230.W3
90mm	3221.W3
200mm	3222.W3



PP	VIN.
50mm	3230.W4
90mm	3221.W4
200mm	3222.W4



PP	VIN.
50mm	3230.W5
90mm	3221.W5
200mm	3222.W5



PP	VIN.
50mm	3230.W6
90mm	3221.W6
200mm	3222.W6



PP	VIN.
50mm	3230.29
90mm	3221.29
200mm	3222.29
300mm	3223.29



PP	VIN.
90mm	3221.M8
200mm	3222.M8



PP	VIN.
200mm	3222.L2
	3232.L2

## VERBODSTEKENS ISO 7010

## SIGNAUX D'INTERDICTION ISO 7010



	PP	VIN.
50mm		3230.06
90mm	3221.06	3231.06
200mm	3222.06	3232.06
300mm	3223.06	3233.06
400mm	3224.06	3234.06



	PP	VIN.
50mm	3220.Q1	3230.Q1
90mm	3221.Q1	3231.Q1
200mm	3222.Q1	3232.Q1



	PP	VIN.
50mm		3230.08
90mm	3221.08	3231.08
150mm		323A.08
200mm	3222.08	3232.08
300mm	3223.08	3233.08
400mm	3224.08	3234.08



Alu anod.		
Alu anod.		Plat
125x125		321B.08
150x150		321A.08

Spiegelbeeld VIN  
VIN Image réfléchie



	PP	VIN.
90mm	3221.S4	3231.S4
200mm	3222.S4	3232.S4



	PP	VIN.
90mm	3221.S7	3231.S7
200mm	3222.S7	3232.S7



	PP	VIN.
90mm	3221.15	3231.15
200mm	3222.15	3232.15
300mm	3223.15	3233.15
400mm	3224.15	3234.15



	PP	VIN.
90mm	3221.M9	3231.M9
200mm	3222.M9	3232.M9



	PP	VIN.
50mm	3220.Q2	3230.Q2
90mm	3221.Q2	3231.Q2
200mm	3222.Q2	3232.Q2



	PP	VIN.
90mm	3221.96	3231.96
200mm	3222.96	3232.96
300mm	3223.96	3233.96



	PP	VIN.
50mm		3230.W2
90mm	3221.W2	3231.W2
200mm	3222.W2	3232.W2



	PP	VIN.
90mm	3221.R1	3231.R1
200mm	3222.R1	3232.R1
300mm	3223.R1	3233.R1
400mm	3224.R1	3234.R1

Greenline Spiegelbeeld VIN  
VIN Image réfl.



	PP	VIN.
90mm	3221.Q9	3231.Q9
200mm	3222.Q9	3232.Q9
300mm	3223.Q9	3233.Q9
400mm	3224.Q9	3234.Q9



	VIN.
200mm	3232.N4



	PP	VIN.
90mm	3221.97	3231.97
200mm	3222.97	3232.97
300mm	3223.97	3233.97



	PP	VIN.
90mm	3221.19	3231.19
200mm	3222.19	3232.19
300mm	3223.19	3233.19
400mm	3224.19	3234.19



	PP	VIN.
90mm	3221.Q7	3231.Q7
200mm	3222.Q7	3232.Q7
300mm	3223.Q7	3233.Q7
400mm	3224.Q7	3234.Q7



	PP	VIN.
90mm	3221.Q8	3231.Q8
200mm	3222.Q8	3232.Q8
300mm	3223.Q8	3233.Q8
400mm	3224.Q8	3234.Q8



ROKEN EN  
OPEN VUUR  
VERBODEN



	PP	VIN.
140x200	3222.58	3232.58
210x300	3224.58	3234.58
300x420		3235.58

	PP	VIN.
140x200	3222.54	3232.54



	PP	VIN.
300x100	3223.F1	3233.F1



	PP	VIN.
300x100	3223.K2	3233.K2
450x150	3224.K2	3234.K2



	PP	VIN.
300x100	3223.W7	3233.W7



	PP	VIN.
300x100	3223.W8	3233.W8

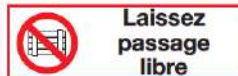

	PP	VIN.
450x150	3224.W9	3234.W9

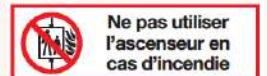

	PP	VIN.
300x100	3223.X9	3233.X9

# VERBODSTEKENS

# SIGNAUX D'INTERDICTION



R/V



Haaks - R/V  
En drapeau - R/V

PP	VIN.	Greenline	Spiegelbeeld VIN VIN Image réfléchie	Forex 5mm	Forex R/V 5mm	SIGNICOLOR 1,5mm	PVC-1mm	PVC-1mm
Ø 30mm	323C.01						120x120	3228.01
Ø 50mm	3220.01		32A0.01					
Ø 90mm	3221.01		32A1.01					
Ø 150mm	322A.01		32AA.01					
Ø 200mm	3222.01	32U2.01	32A2.01			3212.01		
Ø 300mm	3223.01	3233.01	32A3.01			3213.01		
Ø 400mm	3224.01	3234.01				3214.01		
□500mm	3225.01	3235.01						
□600mm	3226.01	3236.01						
□650mm	3227.01	3237.01		32E9.01	32G9.01			
□800mm	3239.01							



Alu anod.  
Alu anod.



Plexi 6mm - bevestigingen inbegr.  
Plexi 6mm - fixations incl.



Plat	Haaks R/V Drap. R/V	Prof.	Prof. Hang. Susp. R/V	Muur Mur	Zijw.R/V Lat.R/V	Plat.R/V	PP	VIN.
125x125	321B.01	32PB.01		150x150	5141.50	5241.50	5441.50	90mm
150x150	321A.01	32PA.01	32PU.01	200x200	5142.50	5242.50	5442.50	150mm
								200mm
								3221.R5
								3231.R5
								322A.R5
								323A.R5
								3232.R5



VIN.	VIN.	PP	VIN.	PP	VIN.
90mm	3231.H1	90mm	3231.G2	90mm	3231.98
200mm	3232.H1	150mm	323A.G2	200mm	3222.98
		200mm	3232.G2	300mm	3223.98
					3233.98



Alu anod.  
Alu anod.



Plexi 6mm - bevestigingen inbegr.  
Plexi 6mm - fixations incl.



PP	VIN.	Greenline	Spiegelbeeld VIN VIN Image réfléchie	SIGNICOLOR 1,5mm	Plat	Prof.	Muur / Mur	Zijw.R/V Lat.R/V	PP	VIN.
50mm	3230.03	32U0.03			125x125	321B.03	32PB.03	150x150	5141.51	5241.51
90mm	3221.03	3231.03	32A1.03		150x150	321A.03	32PA.03	200x200	5142.51	5242.51
150mm	322A.03	323A.03								
200mm	3222.03	3232.03	32U2.03							
300mm	3223.03	3233.03								
400mm	3224.03	3234.03								



PP	VIN.	PP	VIN.	PP	VIN.	Greenline	SIGNICOLOR 1,5mm	PP
50mm	3230.44	200mm	3222.82	Ø 50mm	3230.04			200mm
90mm	3231.44	300mm	3223.82	3233.82	3231.04			
200mm	3222.44	3232.44		Ø 90mm	3221.04			
300mm	3233.44			Ø 200mm	3222.04	3232.04	32U2.04	3212.04
				Ø 300mm	3223.04	3233.04		
				Ø 400mm	3224.04	3234.04		
				□600mm	3236.04			

# VERBODSTEKENS

# SIGNAUX D'INTERDICTION



PP	VIN.
200mm	3232.H6
300mm	3223.H6



PP	VIN.
200mm	3222.B4
3232.B4	



PP	VIN.
200mm	3222.G8
3232.G8	



PP	VIN.
90mm	3231.65
200mm	3222.65
3232.65	



PP	VIN.
200mm	3222.G7
3232.G7	



PP	VIN.
200mm	3232.S1
300mm	3223.S1



PP	VIN.
90mm	3221.88
3231.88	
200mm	3222.88
3232.88	



VIN.	
90mm	3231.87
200mm	3232.87



PP	VIN.
50mm	3230.99
90mm	3231.99
150mm	323A.99
200mm	3222.99
300mm	3223.99
3233.99	



PP	VIN.
50mm	3230.49
90mm	3221.49
3231.49	
200mm	3222.49
3232.49	
300mm	3223.49
3233.49	



PP	VIN.
50mm	3230.64
90mm	3231.64
200mm	3222.64
3232.64	



PP	VIN.
90mm	3221.13
3231.13	
150mm	323A.13
200mm	3222.13
3232.13	
300mm	3223.13
3233.13	



VIN.	
90mm	3231.P2



PP	VIN.
90mm	3221.17
3231.17	
200mm	3222.17
3232.17	



PP	VIN.
200mm	3222.45
3232.45	



PP	VIN.
90mm	3231.47
200mm	3222.47
3232.47	



PP	VIN.
90mm	3231.68
200mm	3222.68
3232.68	



VIN.	
200mm	3232.K3



PP	VIN.
90mm	3231.J6
200mm	3222.J6



VIN.	
90mm	3231.J3



PP	VIN.
90mm	3231.91
200mm	3222.91
3232.91	



VIN.	
50mm	3230.P5
90mm	3231.P5



PP	VIN.
90mm	3221.12
3231.12	
200mm	3222.12
3232.12	



VIN.	
90mm	3231.L1
150mm	323A.L1



VIN.	
200mm	3232.85
300mm	3233.85



VIN.	
30mm	323C.78
50mm	3230.78
90mm	3231.78



PP	VIN.
90mm	3221.11
3231.11	
200mm	3222.11
3232.11	
300mm	3223.11
3233.11	



PP	VIN.
50mm	3230.67
90mm	3231.67
200mm	3222.67
3232.67	



PP	VIN.
90mm	3221.16
3231.16	
200mm	3222.16
3232.16	
400mm	3224.16



VIN.	
90mm	3231.P4



VIN.	
90mm	3231.J5



PP	VIN.
200mm	3222.J2
3232.J2	



PP	VIN.
90mm	3221.10
3231.10	
200mm	3222.10
3232.10	
300mm	3223.10
3233.10	
400mm	3224.10
3234.10	



PP	VIN.
90mm	3221.Q6
3231.Q6	
150mm	322A.Q6
200mm	3222.Q6
3232.Q6	
300mm	3223.Q6
3233.Q6	
400mm	3224.Q6
3234.Q6	

SIGNAUX D'INTERDICTION

VERBODSTEKENS



PP	VIN.	VIN.	PP	VIN.	Spiegelbeeld VIN / VIN image refléchié	SIGNICOLOR 1,5mm	PP	VIN.
90mm	3231.C5	90mm 3231.S3	90mm	3221.07	3231.07		Ø 200mm	3222.B1 3232.B1
200mm	3222.C5 3232.C5	200mm 3232.S3	150mm	322A.07	323A.07		□ 600mm	3226.B1
300mm	3223.C5	400mm 3234.S3	200mm	3222.07	3232.07	32A2.07		
			300mm	3223.07	3233.07			
			400mm	3224.07	3234.07			



PP	VIN.	SIGNICOLOR 1,5mm	PP	VIN.	PP	VIN.	SIGNICOLOR 1,5mm	PP	VIN.
200mm	3222.92	3232.92	90mm	3221.23	3231.23	90mm	3231.24	150mm	323A.40
300mm	3223.92	3233.92 3213.92	200mm	3222.23	3232.23	200mm	3222.24	3232.24	3212.24
400mm	3224.92	3234.92 3214.92	300mm	3223.23	3233.23	300mm	3223.24	3233.24	
			400mm	3224.23	3234.23	400mm	3224.24	3234.24	



PP	VIN.	Greenline	SIGNICOLOR 1,5mm	Alu anod.	Plat	Prof.	PP	VIN.	PP	VIN.
90mm	3221.09	3231.09		125x125	321B.09	32PB.09	300mm	3223.N2	3233.N2	200mm 3222.79 3232.79
150mm	322A.09	323A.09		150x150	321A.09	32PA.09	400mm		3234.N2	300mm 3223.79 3233.79
200mm	3222.09	3232.09	32U2.09							400mm 3224.79
300mm	3223.09	3233.09								
400mm	3224.09	3234.09								



	50mm	90mm	150mm	200mm	300mm	400mm	200mm	300mm	400mm	PP
5 km	PP			3222.60	3223.60	3224.60	1m80	PP	3223.L4	200mm 3222.M2
	VIN.	3231.60		3232.60	3233.60	3234.60		VIN.		400mm 3224.M2
10 km	PP			3222.61	3223.61	3224.61	ALU			
	VIN.	3231.61		3232.61	3233.61	3234.61	2m00	PP	3222.Y3 3223.Y3 3224.Y3	
15 km	PP			3222.62	3223.62	3224.62		VIN.	3232.Y3 3233.Y3 3234.Y3	
	VIN.	3231.62		3232.62	3233.62	3234.62		ALU	3213.Y3	
20 km	PP			3222.63	3223.63	3224.63	2m05	PP	3222.Y4 3223.Y4 3224.Y4	
	VIN.	3231.63		3232.63	3233.63	3234.63		VIN.	3232.Y4 3233.Y4 3234.Y4	
25 km	PP			3222.30	3223.30	3224.30		ALU	3213.Y4	
	VIN.	3230.30		3232.30	3233.30	3234.30	2m10	PP	3222.Y5 3223.Y5 3224.Y5	
30 km	PP			3222.18	3223.18	3224.18		VIN.	3232.Y5 3233.Y5 3234.Y5	
	VIN.	3230.18	3231.18	3232.18	3233.18	3234.18		ALU	3213.Y5	
40 km	PP						2m20	PP	3222.Y6 3223.Y6 3224.Y6	
	VIN.	3231.R2		3232.R2				VIN.	3232.Y6 3233.Y6 3234.Y6	
45 km	PP							ALU	3213.Y6	
	VIN.	3231.R7	323A.R7	3232.R7	3233.R7		2m30	PP	3222.Y7 3223.Y7 3224.Y7	
50 km	PP			3222.M1		3224.M1		VIN.	3232.Y7 3233.Y7 3234.Y7	
	VIN.	3231.M1		3232.M1				ALU	3213.Y7	
60 km	PP			3222.31		3224.31				
	VIN.	3231.31		3232.31	3233.31					
70 km	VIN.									
	PP	3231.K7		3232.K7						
75 km	VIN.			3232.32						
	PP			3222.32						
80 km	VIN.			3232.T0						
	PP									
85 km	VIN.			3232.W0						
	PP									
90 km	VIN.			3232.K8						



PP	VIN.
200mm	3222.46
300mm	3223.46
400mm	3224.46

# VERBODSTEKENS

# SIGNAUX D'INTERDICTION



PP	VIN.	PP	VIN.	Spiegelbeeld VIN / VIN Image réfléchie	SIGNICOLOR 1,5mm	Alu anod.	Plat	Prof.	PP	VIN.
90mm	3221.C9 3231.C9	90mm	3221.20 3231.20	32A1.20		125x125	321B.20	32PB.20	90mm	3221.21 3231.21
200mm	3222.C9 3232.C9	150mm	323A.20	32AA.20		150x150	321A.20	32PA.20	200mm	3222.21 3232.21
300mm	3223.C9 3233.C9	200mm	3222.20 3232.20		3212.20				300mm	3223.21 3233.21
		300mm	3223.20 3233.20						400mm	3224.21 3234.21
		400mm	3224.20 3234.20							



PP	VIN.	PP	VIN.	Spiegelbeeld VIN / VIN Image réfléchie	SIGNICOLOR 1,5mm	PP	VIN.	SIGNICOLOR 1,5mm
200mm	3222.H4 3232.H4	50mm	3230.26			90mm	3231.43	
300mm	3223.H4 3233.H4	90mm	3221.26 3231.26	32A1.26		150mm	323A.43	
		200mm	3222.26 3232.26			200mm	3222.43 3232.43	
		300mm	3223.26 3233.26		3213.26	300mm	3223.43 3233.43	3213.43
						400mm	3224.43 3234.43	



PP	VIN.	PP	VIN.	PP	VIN.	PP	VIN.	Alu anod.	Plat	PP	VIN.
200mm	3222.A4 3232.A4	90mm	3221.C6 3231.C6	150mm	323A.H9	50mm	3220.05 3230.05	125x125	321B.05	90mm	3221.48 3231.48
		200mm	3222.C6 3232.C6	200mm	3222.H9	90mm	3221.05 3231.05	150x150	321A.05	200mm	3222.48 3232.48
						200mm	3222.05 3232.05				
						300mm	3223.05 3233.05				
						400mm	3224.05 3234.05				



PP	VIN.	PP	VIN.	VIN.	PP	VIN.	PP
200mm	3222.H2 3232.H2	200mm	3222.L0 3232.L0	90mm	3231.J1	200mm	3222.76 3232.76
300mm	3223.H2			200mm	3232.J1	300mm	3223.76 3233.76



VIN.	PP	VIN.	PP	VIN.	PP	VIN.	PP	VIN.	
50mm	3230.Q4	200mm	3222.86 3232.86	90mm	3231.N5	90mm	3221.A3	200mm	3222.83 3232.83
200mm	3232.Q4	300mm	3223.86	200mm	3232.N5	200mm	3222.A3 3232.A3	400mm	3234.83
		400mm	3224.86	300mm	3223.N5	300mm	3223.A3 3233.A3		

SIGNAUX D'INTERDICTION

VERBODSTEKENS

# VERBODSTEKENS

# SIGNAUX D'INTERDICTION

SIGNAUX D'INTERDICTION



PP	VIN.	PP	VIN.	PP	VIN.	PP	VIN.	PP	VIN.		
90mm	3221.U4	3231.U4	90mm	3221.U8	3231.U8	90mm	3221.U7	3231.U7	90mm	3221.U0	3231.U0
200mm	3222.U4	3232.U4	200mm	3222.U8	3232.U8	200mm	3222.U7	3232.U7	200mm	3222.U0	3232.U0
300mm	3223.U4	3233.U4	300mm	3223.U8	3233.U8	300mm	3223.U7	3233.U7	300mm	3223.U0	3233.U0



PP	VIN.	PP	VIN.	PP	VIN.	PP	VIN.	PP	VIN.		
90mm	3221.U1	3231.U1	90mm	3221.U3	3231.U3	90mm	3221.U2	3231.U2	90mm	3221.U5	3231.U5
200mm	3222.U1	3232.U1	200mm	3222.U3	3232.U3	200mm	3222.U2	3232.U2	200mm	3222.U5	3232.U5
300mm	3223.U1	3233.U1	300mm	3223.U3	3233.U3	300mm	3223.U2	3233.U2	300mm	3223.U5	3233.U5



PP	VIN.	PP	VIN.	PP	VIN.	PP	VIN.	SIGNICOLOR 1,5mm			
200mm	3222.C7		200mm	3222.S0	3232.S0	90mm	3221.P6	3231.P6	90mm	3221.66	
400mm	3224.C7					200mm	3222.P6	3232.P6	200mm	3222.66	3232.66
											3212.66



PP	VIN.	PP	VIN.	Spiegelbeeld VIN / VIN Image réfléchie	PP	VIN.	PP	VIN.	
90mm	3231.38	90mm	3231.39		90mm	3231.75	90mm	3221.28	
200mm	3222.38	3232.38	200mm	3222.39	3232.39	32A2.39	200mm	3222.75	3232.75
							200mm	3222.28	3232.28



PP	VIN.	PP	VIN.	PP	VIN.	PP	VIN.	PP	VIN.	
50mm	3230.27	90mm	3231.81	50mm	3230.77	90mm	3221.74	3231.74	150mm	323A.G5
90mm	3221.27	3231.27	200mm	3222.81	3232.81	90mm	3221.77	3231.77	200mm	3222.G5
150mm	323A.27	323A.27	300mm	3223.81	3233.81	200mm	3222.77	3232.77		
200mm	3222.27	3232.27								
300mm	3223.27	3233.27								
400mm	3224.27	3234.27								



PP	VIN.	PP	VIN.	PP	VIN.	VIN.	PP	VIN.	
200mm	3222.F5	3232.F5	50mm	3230.33	90mm	3221.22	3231.22	200mm	3232.H3
300mm	3223.F5	3233.F5	90mm	3221.33	3231.33	200mm	3222.22	3232.22	
			150mm	323A.33	300mm	3223.22	3233.22		
			200mm	3222.33	3232.33				
			300mm	3223.33	3233.33				

# VERBODSTEKENS

# SIGNAUX D'INTERDICTION



	PP	VIN.
90mm	3222.36	3231.36
200mm	3222.36	3232.36



	PP	VIN.
90mm	3221.95	3231.95
200mm	3222.95	3232.95
400mm	3224.95	3234.95



	PP	VIN.
90mm	3221.42	3231.42
200mm	3222.42	3232.42
400mm	3224.42	



	VIN.
90mm	3231.M6
200mm	3232.M6



	PP	VIN.
200mm	3223.G6	3232.G6
300mm	3223.G6	3233.G6



	VIN.
90mm	3231.K1
200mm	3232.K1



	PP	VIN.
90mm		3231.69
150mm		323A.69
200mm	3222.69	3232.69
300mm	3223.69	3233.69



	PP	VIN.
90mm	3221.90	3231.90
200mm	3222.90	3232.90



	PP	VIN.
90mm	3223.37	3231.37
300mm	3223.37	3233.37
400mm	3224.37	3234.37



	PP	VIN.
200mm	3222.L3	3232.L3



	PP	VIN.
90mm	3221.M7	3231.M7
200mm	3222.M7	
300mm	3223.M7	3233.M7



	VIN.
90mm	3231.H5
200mm	3232.H5



	PP	VIN.
90mm	3221.A2	3231.A2
200mm	3222.A2	3232.A2



	VIN.
90mm	3231.H8



	PP	VIN.
90mm	3221.34	3231.34
200mm	3222.34	3232.34



	VIN.
90mm	3231.J7



	PP	VIN.	Spiegelbeeld VIN VIN Image réfléchie
90mm	3221.80	3231.80	32A1.80
200mm	3222.80	3232.80	



	VIN.
50mm	3230.L5



	VIN.
90mm	3231.Y1



	PP	VIN.	Greenline	Spiegelbeeld VIN VIN Image réfléchie	FOREX R/V-5mm
Ø 50mm		3230.41			
Ø 90mm	3221.41	3231.41		32A1.41	
Ø 200mm	3222.41	3232.41	32U2.41		
Ø 300mm	3223.41	3233.41			
Ø 400mm	3224.41	3234.41			
□ 800mm					32G9.41



Alu anod.  
Alu anod.

	Plat	Prof.
125x125	321B.41	32PB.41

# VERBODSTEKENS - TEKSTEN

# SIGNAUX D'INTERDICTION - TEXTES



**ROKEN  
VERBODEN**

	PP	VIN.	PP-R/V
140x200	3222.50	3232.50	
210x300	3224.50	3234.50	
300x420	3225.50	3235.50	32J5.50



**VERBODEN  
TE ROKEN**

	PP
400x600	322E.F9



**IN DIT GEBOUW  
GELDT EEN ALGEMEEN  
ROOKVERBOD**

	PP	VIN.	Spiegelbeeld VIN / VIN Image réfléchie
140x200	3222.A5	3232.A5	32A2.A5



**IN DIT LOKAAL  
GELDT EEN ALGEMEEN  
ROOKVERBOD**

**DIT IS EEN ROOKERSVRIJ GEBOUW**



Wettelijk opgelegd rookverbod  
in ALLE bedrijfsgebouwen.  
Dit geldt zowel voor de werk-  
nemers als voor de bezoekers!



**HIER DOVEN**



**TOEGANG VERBODEN  
VOOR ONBEVOEGDEN**

	PP	VIN.	PP	VIN.	PP	VIN.	Spiegelbeeld VIN / VIN Image réfléchie
140x200	3222.G1	3232.G1	300x420	3225.F7	150x200	3232.C3	140x200 3222.51 3232.51 32A2.51
					300x210	3224.C3 3234.C3	210x300 3224.51 3234.51
							300x420 3225.51 3235.51



**TECHNISCHE  
RUIMTE**



**STIKSTOF  
ATMOSFEER**



**TECHNISCHE  
SCHACHT**



**ZUURSTOF  
BEDRIJF**



**VERBODEN VOOR  
VOETGANGERS**

	VIN.	PP	VIN.	PP	PP	VIN.
140x200	3232.L8	140x200	3222.A8	140x200	3232.L9	140x200 3222.A9
						140x200 3222.52 3232.52
						210x300 3224.52
						300x420 3225.52



**HOOGSPANNING  
VERBODEN  
AAN TE RAKEN**



**VERPLICHT  
MOTOR AFZETTEN**



**VERBODEN  
HIER TE  
PARKEREN**



**VERBODEN  
RIJWIELEN  
TE PLAATSEN**

	PP	PP	VIN.	PP	VIN.	PP	VIN.	Spiegelbeeld VIN / VIN Image réfléchie
140x200	3222.T6	140x200	3222.56	3232.56	140x200	3222.59	3232.59	140x200 3222.57 3232.57 32A2.57
210x300	3224.T6				210x300	3224.59	3234.59	



**BIJ BRAND  
VERBODEN LIFT  
TE GEBRUIKEN**



**GEEN  
DRINKWATER**



**NO  
PICK-NICK**



**PACEMAKERS  
VERBODEN**



**RADIO'S  
VERBODEN**

	PP	VIN.	PP	VIN.	PP	PP
140x200	3222.M4	3232.M4	60x80	3231.53	140x200	3222.L7
			140x200	3222.53	3232.53	140x200 3222.A7
						140x200 3222.C1



**HIER UW EIGEN TEKST  
ICI VOTRE PROPRE TEXTE**



Verboden toegang  
voor onbevoegden



**VERBODEN  
HIER TE  
PARKEREN**

Borden nodig in steviger materiaal?  
Prijs voor Dibond, Aluminium en  
andere materialen op aanvraag.

Beso in des panneaux dans un matériel plus dur ?  
Demandez prix pour des panneaux en Dibond,  
Aluminium...

	PP	VIN.	PP	VIN.	PP	VIN.
140x200	3222.55	3232.55	140x200	3222.MTS	3232.MTS	140x200 3222.EA 3232.EA
						210x300 3224.EA 3234.EA

# VERBODSTEKENS - TEKSTEN

# SIGNAUX D'INTERDICTION - TEXTES



DEFENSE  
DE FUMER



INTERDICTION  
DE FUMER



INTERDICTION  
DE FUMER  
DANS LE BATIMENT



ETEINDRE ICI  
↓

PP	VIN.	PP-R/V	PP	VIN.	PP	VIN.	PP	VIN.
140x200	3222.70	3232.70	210x300	3224.E9	3234.E9	140x200	3222.E8	3232.E8
210x300	3224.70	3234.70						
300x420	3225.70	3235.70	32J5.70			150x120		3232.C4
						300x210	3224.C4	3234.C4



ACCES INTERDIT  
AUX PERSONNES  
NON AUTORISEES



DEFENSE  
AUX PIETONS



ARRETER  
MOTEUR OBLIGE



DEFENSE  
DE  
STATIONNER



INTERDICTION  
DE PLACER DES  
BICYCLETES

PP	VIN.	PP	VIN.	VIN.	PP	PP	VIN.
140x200	3222.71	3232.71	140x200	3222.73	3232.73	140x200	3232.M5
210x300	3224.71					210x300	3224.T1
300x420	3225.71					140x200	3222.C2
							3232.C2



EAU  
NON POTABLE

VERBODEN TE ROKEN



NO SMOKING

PP	VIN.	PP
140x200	3222.72	3232.72
		300x420
		3225.F6



ROKEN  
VERBODEN



ALGEMEEN  
ROOKVERBOD



ROOKVRIJ  
GEBOUW  
K.B. 10 JANUARI 2006



TOEGANG  
VERBODEN

PP	VIN.	PP	VIN.	PP	VIN.	PP	VIN.
300x100	3223.D1	3233.D1	150x50	3231.F2	300x100	3223.F8	3233.F8
			300x100	3223.F2	3233.F2		
			450x150	3224.F2	3234.F2	300x100	3223.D4
							3233.D4



Toegang verboden  
voor onbevoegden



DOORGANG  
VERBODEN



GEEN  
INGAANG



GEEN  
UITGANG

PP	VIN.	PP	VIN.	PP	VIN.	PP	VIN.
300x100	3223.D2	3233.D2	300x100	3223.D3	3233.D3	300x100	3223.D5
							3233.D5
						300x100	3223.D6
							3233.D6



NIET  
DUIKEN



GSM VERPLICHT  
UITSCHAKELN



Gebruik van  
GSM verboden

GEEN ongeadresseerd reclamedrukwerk aanb!

PP	VIN.	PP	VIN.	PP	VIN.	VIN.
300x100	3223.F4	3233.F4	300x100	3223.M0	3233.M0	300x100
						3223.D7
						3233.D7
						120x20
						3231.T5

## VERBODSTEKENS - TEKSTEN



**DEFENSE  
DE FUMER**

	PP	VIN.
300x100	3223 .D8	3233 .D8



**ACCES  
INTERDIT**

	PP	VIN.
300x100	3223 .E2	3233 .E2

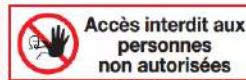

**Accès interdit aux  
personnes  
non autorisées**

	PP	VIN.
300x100	3223 .D9	3233 .D9



**PASSAGE  
INTERDIT**

	PP	VIN.
300x100	3223 .E1	3233 .E1



**PAS  
D'ENTREE**

	PP	VIN.
300x100	3223 .E3	3233 .E3



**PAS  
DE SORTIE**

	PP	VIN.
300x100	3223 .E4	3233 .E4

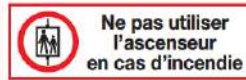

**Ne pas utiliser  
l'ascenseur  
en cas d'incendie**

	VIN.
300x100	3233 .N7



**Utilisation  
GSM interdit**

	PP	VIN.
300x100	3223 .E5	3233 .E5



**Unauthorised persons  
not allowed**

	VIN.
300x100	3233 .N8



**NO ENTRANCE**

	PP	VIN.
450x100	3224 .K6	3234 .K0
450x150	3224 .K0	3234 .K0



**Unauthorised presence  
within this area  
is a Breach of Security**

	VIN.
500x150	3234 .J9



**No entry  
to unauthorised  
personnel**

	VIN.
500x150	3234 .J8

## Parkeerverbod

## Interdiction de stationner



Blanco  
Blanco

	VIN.
180x135	3232 .L6



Blanco  
Blanco

	VIN.
180x135	3232 .M3



Met uw eigen tekst  
Avec votre propre texte

	VIN.
180x135	TE311 .MT



Met uw eigen tekst  
Avec votre propre texte

	VIN.
180x135	TE312 .MT



**VERBODEN  
TE PARKEREN**

**INTERDICTION  
DE STATIONNER**

	ULTR. DESTR.
90x140	3232 .E6

## Richting voor deuren

## Direction pour portes



	VIN.
500x120	3433 .K9



	VIN.
500x120	3233 .B0

**ONS ASSORTIMENT TEKSTBORDEN  
NOTRE ASSORTIMENT PANNEAUX TEXTES**

duwen	<b>VERBODEN TOEGANG VOOR ONBEVOEGDEN</b>
privaat	
entrée interdite	
pag. 166 - 167	<b>PARKING PRIVÉ</b>

Pag. 172-177  
Pag. 172-177

# GEBODSTEKENS ISO 7010

# SIGNAUX D'OBLIGATION ISO 7010

SIGNAUX D'OBLIGATION ISO 7010



Bevestigingen inbegr.  
Fixations incl.

Zijwaarts - bevestigingen inbegr.  
Latéral - fixations incl.

Zwarte eindkappen  
Finition noire

PP	VIN.	Greenline	SIGNICOLOR 1,5mm	Plexi 6mm	Plexi 6mm	Zijwaarts - bevestigingen inbegr. Latéral - fixations incl.	Zijwaarts - bevestigingen inbegr. Latéral - fixations incl.	Alu anod. - 1,5mm	Alu anod. - 1,5mm	Alu anod. Prof.	Alu anod. Prof.
Ø 50mm	3420.J6	3430.J6		150x150	5141.U2	150x150	5241.U2	125x125	341B.J6	125x125	34PB.J6
Ø 90mm	3421.J6	3431.J6		200x200	5142.U2	200x200	5242.U2	150x150	341A.J6	150x150	34PA.J6
Ø 200mm	3422.J6	3432.J6	34U2.J6								
Ø 300mm	3423.J6	3433.J6									
Ø 400mm	3424.J6	3434.J6	34U4.J6								
□ 600mm	3426.J6	3436.J6									



PP	VIN.	Greenline	SIGNICOLOR 1,5mm	PP	VIN.	Greenline	SIGNICOLOR 1,5mm	PP	VIN.	Greenline	SIGNICOLOR 1,5mm
50mm	3420.J8	3430.J8		50mm	3420.J3	3430.J3		50mm	3420.05	3430.05	
90mm	3421.J8	3431.J8		90mm	3421.J3	3431.J3		90mm	3421.05	3431.05	
200mm	3422.J8	3432.J8	34U2.J8	200mm	3422.J3	3432.J3	34U2.J3	200mm	3422.05	3432.05	34U2.05
300mm	3423.J8	3433.J8		300mm	3423.J3	3433.J3		300mm	3423.05	3433.05	
400mm	3424.J8	3434.J8		400mm	3424.J3	3434.J3		400mm	3424.05	3434.05	



PP	VIN.	Greenline	SIGNICOLOR 1,5mm	PP	VIN.	Greenline	SIGNICOLOR 1,5mm	PP	VIN.	Greenline	SIGNICOLOR 1,5mm
50mm	3420.06	3430.06		50mm	3420.J4	3430.J4		50mm	3420.B5	3430.B5	
90mm	3421.06	3431.06		90mm	3421.J4	3431.J4		90mm	3421.B5	3431.B5	
150mm	342A.06	343A.06		200mm	3422.J4	3432.J4	34U2.J4	200mm	3422.B5	3432.B5	34U2.B5
200mm	3422.06	3432.06	34U2.06	300mm	3423.J4	3433.J4		300mm	3423.B5	3433.B5	
300mm	3423.06	3433.06		400mm	3424.J4	3434.J4		400mm	3424.B5	3434.B5	
400mm	3424.06	3434.06									



PP	VIN.	Alu	PP	VIN.	Greenline	Alu	PP	VIN.	PP	VIN.
50mm	3420.G9	3430.G9	50mm	3430.H0			50mm	3430.H1	90mm	3421.F2
90mm	3421.G9	3431.G9	90mm	3421.H0	3431.H0		90mm	3421.H1	3431.H1	3431.F2
150mm	343A.G9		150mm	343A.H0			200mm	3422.H1	3432.H1	3432.F2
200mm	3422.G9	3432.G9	200mm	3422.H0	3432.H0	34U2.H0	300mm	3423.H1	3433.H1	
300mm	3423.G9	3433.G9	300mm	3423.H0	3433.H0	3413.H0	400mm	3424.H1	3434.H1	
400mm	3424.G9	3434.G9	3414.G9	400mm	3424.H0	3434.H0				



PP	VIN.	PP	VIN.	PP	VIN.	PP	VIN.	Greenline	SIGNICOLOR 1,5mm	
90mm	3421.F0	3431.F0	50mm	3430.B5	90mm	3431.13	50mm	3420.J1	3430.J1	
200mm	3422.F0	3432.F0	200mm	3422.B5	3432.B5	200mm	3422.13	3432.13	90mm	3421.J1
300mm	3423.F0					300mm	3423.13	3433.13	200mm	3422.J1
						400mm	3424.13	3434.13	34U2.J1	3412.J1
									300mm	3423.J1
									400mm	3424.J1
										3434.J1

GEBODSTEKENS ISO 7010

# GEBODSTEKENS ISO 7010

# SIGNAUX D'OBLIGATION ISO 7010



PP	VIN.	PP	VIN.	PP	VIN.	PP	VIN.	PP	VIN.					
50mm	3420.J2	3430.J2	50mm	3420.J9	3430.J9	90mm	3421.24	3431.24	90mm	3421.F4	3431.F4	90mm	3421.37	3431.37
90mm	3421.J2	3431.J2	90mm	3421.J9	3431.J9	200mm	3422.24	3432.24	200mm	3422.F4	3432.F4	200mm	3422.37	3432.37
200mm	3422.J2	3432.J2	200mm	3422.J9	3432.J9	300mm	3423.24	3433.24						
300mm	3423.J2	3433.J2	300mm	3423.J9	3433.J9	400mm	3424.24							
400mm	3424.J2	3434.J2	400mm	3424.J9	3434.J9									



PP	VIN.	PP	VIN.	PP	VIN.	PP	VIN.	VIN.					
200mm	3422.44	3432.44	90mm	3421.B7	3431.B7	50mm	3421.11	3431.11	90mm	3421.B4	3431.B4	50mm	3430.F5
			200mm	3422.B7	3432.B7	90mm	3421.11	3431.11	200mm	3422.B4	3432.B4	90mm	3431.F5
						200mm	3422.11	3432.11					
						300mm	3423.11	3433.11					
						400mm	3424.11	3434.11					



PP	VIN.	
90mm	3421.F1	3431.F1
200mm	3422.F1	3432.F1
300mm	3433.F1	

GEBUIK UW SIGNALISATIE RECHTSTREEKS IN COMBINATIE MET DE VEILIGHEIDSMIDDELEN  
 UTILISEZ VOTRE SIGNALISATION EN COMBINAISON AVEC VOTRE EQUIPEMENT DE SECURITE



Ons assortiment pagina 111-112  
 Notre assortiment page 111-112

# GEBODSTEKENS ISO 7010

# SIGNAUX D'OBLIGATION ISO 7010



	PP	VIN.
90mm	3421.K7	3431.K7
200mm	3422.K7	3432.K7
300mm	3423.K7	3433.K7



	PP	VIN.
90mm	3421.K8	3431.K8
200mm	3422.K8	3432.K8



	PP	VIN.
90mm	3421.AQ	3431.AQ
200mm	3422.AQ	3432.AQ



	PP	VIN.
90mm	3421.L0	3431.L0
200mm	3422.L0	3432.L0



	PP	VIN.
90mm	3421.L1	3431.L1
200mm	3422.L1	3432.L1



	PP	VIN.
90mm	3421.L8	3431.L8
200mm	3422.L8	3432.L8



	PP	VIN.
90mm	3421.27	3431.27
200mm	3422.27	3432.27
300mm	3423.27	3433.27
400mm	3424.27	3434.27



	PP	VIN.
50mm		3430.B3
90mm	3421.B3	3431.B3
200mm	3422.B3	3432.B3



	PP	VIN.
50mm	3420.F6	3430.F6
90mm	3421.F6	3431.F6
200mm	3422.F6	3432.F6
300mm	3423.F6	



	PP	VIN.
50mm	3420.88	3430.88
90mm	3421.88	3431.88
200mm	3422.88	3432.88



	PP	VIN.
50mm	3420.87	3430.87
90mm	3421.87	3431.87
200mm	3422.87	3432.87



	VIN.
50mm	3430.F3
90mm	3431.F3



	PP	VIN.
90mm	3421.32	3431.32
200mm	3422.32	3432.32



	PP	VIN.
90mm	3421.B6	3431.B6
200mm	3422.B6	3432.B6
300mm	3423.B6	



	PP	VIN.
50mm		3430.L4
90mm		3431.L4
200mm	3422.L4	
300mm	3423.L4	



	PP	VIN.
90mm	3421.L6	3431.L6
200mm	3422.L6	3432.L6
300mm	3423.L6	3433.L6
400mm	3424.L6	3434.L6



	PP	VIN.
90mm	3421.L7	3431.L7
200mm	3422.L7	3432.L7



	PP	VIN.
90mm	3421.L9	3431.L9
200mm	3422.L9	3432.L9



	PP	VIN.
90mm	3421.M0	3431.M0
200mm	3422.M0	3432.M0



	PP	VIN.
90mm	3421.M1	3431.M1
200mm	3422.M1	3432.M1



	PP	VIN.
90mm	3421.M2	3431.M2
200mm	3422.M2	3432.M2



	PP	VIN.
90mm	3421.M3	3431.M3
200mm	3422.M3	3432.M3



	PP	VIN.
90mm	3421.M4	3431.M4
200mm	3422.M4	3432.M4



	PP	VIN.
90mm	3421.M5	3431.M5
200mm	3422.M5	3432.M5



	PP	VIN.
90mm	3421.M6	3431.M6
200mm	3422.M6	3432.M6



	PP	VIN.
90mm	3421.M7	3431.M7
200mm	3422.M7	3432.M7

EEN GOEDE SIGNALISATIE VRAAGT OM EEN CORRECTE BEVESTIGING  
UNE BONNE SIGNALISATION DEMANDE UNE FIXATION CORRECTE



Assortiment vanaf pagina 179 - Assortiment à partir de la page 179

# GEBODSTEKENS ISO 7010

# SIGNAUX D'OBLIGATION ISO 7010



PP	VIN.	PP	VIN.	PP	VIN.	PP	VIN.	PP	VIN.					
140x200	3422.D1	3432.D1	140x200	3422.D2	3432.D2	140x200	3422.D3	3432.D3	140x200	3422.D4	3432.D4	140x200	3422.D5	3432.D5



PP	VIN.	PP	VIN.	PP	VIN.	PP	VIN.	PP	VIN.					
140x200	3422.D6	3432.D6	140x200	3422.D7	3432.D7	140x200	3422.D8	3432.D8	140x200	3422.D9	3432.D9	140x200	3422.A6	3432.A6



PP	VIN.	PP	VIN.	PP	VIN.	PP	VIN.	PP	VIN.					
140x200	3422.T9	3432.T9	140x200	3422.U9	3432.U9	140x200	3422.W8	3432.W8	140x200	3422.W9	3432.W9	140x200	3422.76	3432.76



PP	VIN.	PP	VIN.	PP	VIN.	PP	VIN.	PP	VIN.	PP	VIN.						
140x200	3422.74	3432.74	140x200	3422.X7	3432.X7	140x200	3422.77	3432.77	140x200	3422.X8	3432.X8	140x200	3422.K0	3432.K0	140x200	3422.K1	3432.K1



PP	PP	PP	PP	PP					
450x150	3425.X9	450x150	3425.AA	450x150	3425.AB	450x150	3425.AC	450x150	3425.AD



PP	VIN	PP	PP	PP	PP					
300x100	3422.79	3432.79	450x150	3425.AE	450x150	3425.AF	450x150	3425.AG	450x150	3425.H5

450x150 3425.79



PP	PP	VIN	VIN Multigrip	VIN Multigrip				
450x150	3425.H3	300x100	3422.AH	3432.AH	120x40	34L1.G7	120x40	34L1.G8

450x150 3425.AH

# GEBODSTEKENS

# SIGNAUX D'OBLIGATION



PP	VIN.	Greenline	Signicolor 1,5mm	PP	VIN.	Greenline	Signicolor 1,5mm	PP	VIN.
Ø 50mm	3420.02	3430.02		50mm	3420.03	3430.03		50mm	3420.26
Ø 90mm	3421.02	3431.02		90mm	3421.03	3431.03		90mm	3421.26
Ø 150mm	342A.02	343A.02		200mm	3422.03	3432.03	34U2.03	200mm	3422.26
Ø 200mm	3422.02	3432.02	34U2.02	3412.02	300mm	3423.03	3433.03	3413.03	300mm
Ø 300mm	3423.02	3433.02	3413.02	400mm	3424.03	3434.03		400mm	3424.26
Ø 400mm	3424.02	3434.02	34U4.02	3414.02					
□ 600mm	3426.02	3436.02							



PP	VIN.	Greenline	Signicolor 1,5mm	PP	VIN.	Greenline	Signicolor 1,5mm	PP	VIN.
Ø 50mm	3420.04	3430.04		50mm	3420.10	3430.10		50mm	3420.19
Ø 90mm	3421.04	3431.04		90mm	3421.10	3431.10		90mm	3421.19
Ø 200mm	3422.04	3432.04	3412.04	200mm	3422.10	3432.10	34U2.10	200mm	3422.19
Ø 300mm	3423.04	3433.04	3413.04	300mm	3423.10	3433.10		300mm	3423.19
Ø 400mm	3424.04	3434.04	3414.04	400mm	3424.10	3434.10		400mm	3424.19
□ 600mm	3426.04								



PP	VIN.	Greenline	PP	VIN.	Greenline	Signicolor 1,5mm	PP	VIN.
50mm	3430.20		50mm	3420.01	3430.01		50mm	3420.16
90mm	3421.20	3431.20	90mm	3421.01	3431.01		90mm	3421.16
200mm	3422.20	3432.20	200mm	3422.01	3432.01	34U2.01	200mm	3422.16
300mm	3423.20	3433.20	300mm	3423.01	3433.01	3413.01	300mm	3423.16
400mm	3424.20	3434.20	400mm	3424.01	3434.01		400mm	3424.16



PP	VIN.	PP	VIN.	PP	VIN.	Signicolor 1,5mm	PP
50mm	3430.21	50mm	3430.22	50mm	3420.25	3430.25	200mm
90mm	3421.21	3431.21	90mm	3421.22	3431.22	3431.25	3422.B9
200mm	3422.21	3432.21	200mm	3422.22	3432.22	3412.25	
300mm	3423.21	3433.21	300mm	3423.22	3433.22	3413.25	
400mm	3424.21	3434.21	400mm	3424.22	3434.22		



PP	VIN.	PP	VIN.	PP	VIN.	PP	VIN.
200mm	3422.64	90mm	3421.39	3431.39	90mm	3431.42	90mm
		200mm	3422.39	3432.39	200mm	3432.42	150mm
					300mm	3423.42	3433.42
							200mm



VIN.	VIN.
200mm	3432.90
90mm	3431.67

SIGNAUX D'OBLIGATION

GEBODSTEKENS

# GEBODSTEKENS

# SIGNAUX D'OBLIGATION



PP	VIN.	Greenline	Signicolor 1,5mm	PP	VIN.	PP	VIN.	PP	VIN.
50mm	3430.09			90mm	3431.93	90mm	3421.18 3431.18	90mm	3421.17 3431.17
90mm	3421.09 3431.09	34U1.09		200mm	3422.93	200mm	3422.18 3432.18	150mm	343A.17
150mm	343A.09					300mm	3423.18 3433.18	200mm	3422.17 3432.17
200mm	3422.09 3432.09	34U2.09				400mm	3424.18 3434.18	300mm	3423.17 3433.17
300mm	3423.09 3433.09		3413.09						
400mm	3424.09 3434.09		3414.09						



PP	VIN.	PP	VIN.	VIN.	PP	VIN.	PP
200mm	3422.96 3432.96	90mm	3421.F7 3431.F7	90mm	3431.66	90mm	3421.A5 3431.A5
		200mm	3422.F7 3432.F7	200mm	3432.66	200mm	3422.A5 3432.A5



VIN.	PP	VIN.	PP	VIN.	PP	VIN.	PP	VIN.	
50mm	3430.69	90mm	3421.98 3431.98	50mm	3430.30	50mm	3420.35 3430.35	200mm	3422.99 3432.99
		200mm	3422.98 3432.98	200mm	3422.30 3432.30	90mm	3421.35 3431.35		
				300mm	3423.30 3433.30	200mm	3422.35 3432.35		



PP	VIN.	Signicolor 1,5mm	PP	VIN.	VIN.	PP	VIN.	
90mm	3421.12 3431.12		90mm	3421.81 3431.81	90mm	3431.E0	90mm	3421.82 3431.82
150mm	342A.12		200mm	3422.81 3432.81			200mm	3422.82 3432.82
200mm	3422.12 3432.12	3412.12	300mm	3423.81 3433.81			300mm	3423.82 3433.82
300mm	3423.12 3433.12							
400mm	3424.12 3434.12	3414.12						



PP	VIN.	PP	VIN.	PP	VIN.	PVC 1mm - R/V	PP	VIN.	
200mm	3422.A7 3432.A7	90mm	3421.B1 3431.B1	50mm	3430.36	120x120mm	3428.36	200mm	3432.A3
		200mm	3432.B1	90mm	3421.36 3431.36			300mm	3423.A3 3433.A3
				200mm	3422.36 3432.36				



PP	VIN.	Greenline	PP	VIN.	VIN.	PP	VIN.	
50mm	3430.B8		200mm	3432.A2	200mm	3432.A0	200mm	3432.A1
90mm	3431.B8		300mm	3423.A2 3433.A2			300mm	3423.A1 3433.A1
200mm	3422.B8 3432.B8	34U2.B8						
300mm	3423.B8							

SIGNAUX D'OBLIGATION

GEBODSTEKENS

GEBODSTEKENS

SIGNAUX D'OBLIGATION



	PP	VIN.
50mm	3422.08	3430.08
200mm	3422.08	3432.08
400mm	3424.08	3434.08



	PP	VIN.	SIGNICOLOR 1,5mm
90mm		3431.07	
200mm	3422.07	3432.07	3412.07
400mm	3424.07	3434.07	3414.07



	PP	VIN.
90mm	3421.38	3431.38
200mm	3422.38	3432.38



	PP	VIN.
90mm		3431.34
200mm	3422.34	3432.34
400mm	3424.34	3434.34



	PP	VIN.
90mm	3421.28	3431.28
200mm	3422.28	3432.28
300mm	3423.28	3433.28
400mm	3424.28	



	PP	VIN.
200mm	3422.41	3432.41
300mm	3423.41	



	PP
200mm	3422.97



	PP	VIN.	SIGNICOLOR 1,5mm
90mm	3421.15	3431.15	
200mm	3422.15	3432.15	
300mm	3423.15	3433.15	
400mm	3424.15	3434.15	3414.15



	PP	VIN.	SIGNICOLOR 1,5mm
50mm		3430.43	
300mm	3423.43	3433.43	3413.43
400mm	3424.43		



	PP	VIN.
90mm	3421.91	3431.91
200mm	3422.91	3432.91
300mm	3423.91	



	PP	VIN.
200mm	3422.40	3432.40



	PP	VIN.
90mm	3421.14	3431.14
200mm	3422.14	3432.14
300mm	3423.14	3433.14
400mm	3424.14	3434.14



	VIN.
90mm	3431.C0



	PP	VIN.
90mm	3421.31	3431.31
200mm	3422.31	3432.31



	VIN.
200mm	3432.A8



	VIN.
50mm	3430.45
90mm	3431.45



	PP	VIN.
50mm		3430.46
90mm	3421.46	3431.46
200mm	3422.46	3432.46
300mm	3423.46	3433.46
400mm	3424.46	3434.46



	VIN.
50mm	3430.92
200mm	3432.92



	PP	VIN.
90mm		3431.47
200mm	3422.47	3432.47



	PP	VIN.
90mm		3431.48
200mm	3422.48	3432.48



	PP	VIN.
90mm		3431.49
200mm	3422.49	3432.49



	PP	VIN.
90mm		3431.L3
200mm	3422.L3	3432.L3



	PP	VIN.
90mm		3431.G2
200mm	3422.G2	3432.G2



	PP	VIN.
90mm		3431.B2
200mm	3422.B2	3432.B2



	PP	VIN.
50mm		3430.00
90mm	3421.00	3431.00
200mm	3422.00	3432.00
300mm	3423.00	3433.00
400mm	3424.00	3434.00

# GEBODSTEKENS - TEKSTEN

# SIGNAUX D'OBLIGATION - TEXTES



	PP	VIN.		PP	VIN.		PP	VIN.		PP	VIN.
140x200	3422.51	3432.51		3422.52	3432.52		3422.53	3432.53		3422.59	3432.59



	PP	VIN.		PP	VIN.		PP	VIN.		PP	VIN.
140x200	3422.61	3432.61		3422.55	3432.55		3422.F9	3432.F9		3422.60	3432.60



	PP	VIN.		PP	VIN.		PP	VIN.		PP	VIN.
140x200	3422.63	3432.63		3422.F8	3432.F8		3422.58	3432.58		3422.84	3432.84



	PP	VIN.		PP	VIN.		PP	VIN.		PP	VIN.
140x200	3422.C1	3432.C1		3422.C2	3432.C2		3422.C8	3432.C8		3422.C4	3432.C4



	PP	VIN.		PP	VIN.		PP	VIN.
140x200	3422.C7	3432.C7		3422.K4	3432.K4		3422.E3	3432.E3

# GEBODSTEKENS - TEKSTEN

# SIGNAUX D'OBLIGATION - TEXTES



	PP	VIN.		PP	VIN.		PP	VIN.		PP	VIN.			
140x200	3422.71	3432.71	140x200	3422.72	3432.72	140x200	3422.73	3432.73	140x200	3422.70	3432.70	140x200	3422.75	3432.75



	PP	VIN.		PP	VIN.		PP	VIN.
140x200	3422.K5	3432.K5	140x200	3422.78	3432.78	140x200	3422.83	3432.83



	PP
450x150	3425.AL

	PP
450x150	3425.AM

	PP
450x150	3425.H8

	PP
450x150	3425.AN

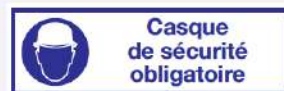

	PP
450x150	3425.AR

	VIN.
300x100	3432.E6

	PP
450x150	3425.E8

	PP
450x150	3425.E9



	PP
450x150	3425.H2

	PP
450x150	3425.E7

	PP
450x150	3425.H4

	VIN.
300x100	3432.AP



MAXI  
236x315x200mm



MIDI  
236x225x125mm



MINI  
236x120x120mm



ISO7010

	Box zonder picto Box sans picto							
Mini	Blauw / Bleu Transp.	34A1.00 34B1.00	34A1.J2 34B1.J2		34A1.05 34B1.05	34A1.J4 34B1.J4		
Midi	Blauw / Bleu Transp.	34A2.00 34B2.00	34A2.J2 34B2.J2	34A2.J3 34B2.J3	34A2.05 34B2.05	34A2.J4 34B2.J4		
Maxi	Blauw / Bleu Transp.	34A3.00 34B3.00	34A3.J2 34B3.J2				34A3.J6 34B3.J6	34A3.B5 34B3.B5
								34A3.J1 34B3.J1

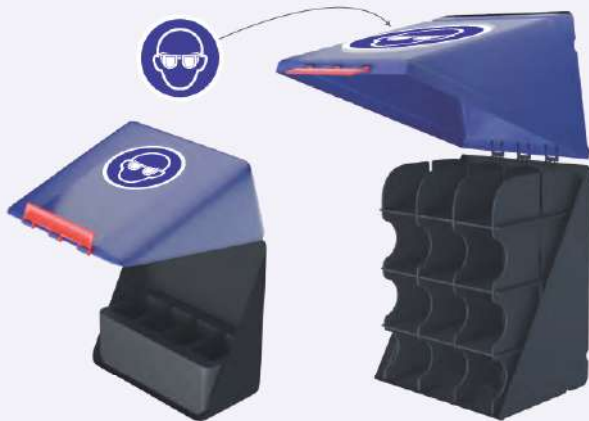

Box met sorteervakken - Zonder brillen  
Box avec compartiments - Sans lunettes

	Midi-4	Maxi-12
Blauw / Bleu	34A5.J3	34A6.J3
Transp.	34B5.J3	34B6.J3



Sorteervak voor maxi - Zonder box - Voor 12 brillen - Zonder brillen  
Compartment pour maxi - Sans box - Pour 12 lunettes - Sans lunettes

34C2.00



Sorteervak voor midi - Zonder box - Voor 4 brillen - Zonder brillen  
Compartment pour midi - Sans box - Pour 4 lunettes - Sans lunettes

34C1.00

# SECUBOX - SECUPOINT

Personaliseer uw SECUBOX/SECUPOINT

Personnalisez votre SECUBOX/SECUPOINT



MAXI



SECUPOINT

	Mini	Midi	Maxi	Midi+vak Midi+ compartiment	Maxi+vak Maxi+ compartiment	Secupoint
Blauw Bleu	34A1.MT	34A2.MT	34A3.MT	34A5.MT	34A6.MT	34A4.MT
Transp. Transp.	34B1.MT	34B2.MT	34B3.MT	34B5.MT	34B6.MT	

# SECUBOX - DISPENSER



DISPENSER : 600x210x242mm  
 3 VAKKEN VAN 245x180x220mm - Niet gevuld  
 DISTRIBUTEUR: 600x210x242mm  
 3 COMPARTIMENTS DE 245x180x220mm - Non remplis

34A9.01

# SECUBOX - DISTRIBUTEUR



DISPENSER : 600x178x206mm  
 4 VAKKEN VAN 127x138x190mm - Niet gevuld  
 DISTRIBUTEUR: 600x178x206mm  
 4 COMPARTIMENTS DE 127x138x190mm - Non remplis

34AA.01

# SECUCASE



NIET GEVULD  
 NON REMPLI

	ISO	
250x200x70	34A7.01	34A7.02
340x270x80	34A8.01	34A8.02

# SECUCASE

# SECUPOINT



# SECUPOINT

ISO					
Blauw Bleu	34A4.J1	34A4.J6	34A4.J8	34A4.J3	34A4.B5



Oogspoelfles  
Rince-œil

250ml	31A4.01
500ml	31A2.01



Wandhouder voor fles 500ml  
Support mural pour flacon 500ml

31A3.01



Secubox voor flessen 250ml  
Secubox pour flacons 250ml

236x225x125mm 31A1.01

EERSTE HULP PICTOGRAMMEN

PICTOGRAMMES PREMIERS SECOURS



BESCHIKBAAR OP PAG. 17-18

DISPONIBLE PAG. 17-18

## Brandwondenverzorging

## Soin brûlures

De brandwondenverzorging van Burncare helpt infecties te voorkomen en genezing te bevorderen. Burncare bevat een natuurlijk extract en de effecten komen volwaardig overeen met die van het koelen met lauw stromend water. Het zorgt ervoor dat na ongeveer 5 tot 10 minuten de huidtemperatuur stabiliseert op een niveau dat 4 à 5°C onder de normale huidtemperatuur ligt.

Burncare prévient l'infection et favorise la guérison. Il contient un extrait naturel et son effet correspond au refroidissement de la brûlure à l'eau courante tiède. Il vieillit, qu'après 5 à 10 minutes, la température de la peau se stabilise à un niveau inférieur de 4 à 5 °c de la température normale de la peau.



Wondkompresen  
Compresses

50x50mm	31B10
100x100mm	31B20
200x200mm	31B30



Brandwondengel  
Gel brûlures

3,5gr per/par 6	31B40
59ml	31B50
118ml	31B60



Brandwondenspray  
Spray brûlures

50ml	31B70
------	-------



MINI  
236x120x120mm



Transp.	34B1.AA	34B1.AB	34B1.AC
---------	---------	---------	---------



MIDI  
236x225x125mm



Transp.	34B2.AA	34B2.AB	34B2.AC
---------	---------	---------	---------

## Vital ID

## Vital ID

De Vital ID card is speciaal ontwikkeld voor de werkende man en zijn veiligheid. De ID card kan bvb. op een helm aangebracht worden. Op de uittrekbare strip worden gegevens genoteerd die cruciaal kunnen zijn bij een ongeval, zoals persoonlijke gegevens, contactnummers, gebruikte medicatie, allergieën,...

La carte Vital ID est spécialement conçue pour l'homme au travail et sa sécurité. Par exemple on peut monter la carte d'identité sur un casque. Sur la bande étirable sont notées les données qui peuvent être cruciales dans un accident: données personnelles, numéros de téléphone, médicaments utilisés, allergies, ...



Standard

70x15mm	E90100
---------	--------



Data Window

85x20mm	E90200
---------	--------



# INTERVENTIE SIGNALISATIE

Zuignap inbegrepen - Enkelzijdig

# SIGNALISATION D'INTERVENTION

Ventouse incluse - Simple face



Dokter  
Médecin

	PP
105x130	452F.81



Dierenarts  
Vétérinaire

	PP
105x130	452F.82



Verpleegkundige  
Infirmière

	PP
105x130	452F.83



Kinesitherapeut  
Kinésithérapeute

	PP
105x130	452F.84



Ambulancier  
Ambulancier

	PP
105x130	452F.85



Apotheker  
Pharmacien

	PP
105x130	452F.88



	PP
105x130	452F.86



	PP
105x130	452F.87



Enkelzijdig

Simple face



	PP
200x100	452G.91



	PP
200x100	452G.92



	PP
200x100	452G.93



	PP
200x100	452G.94



	PP
200x100	452G.95



	PP
200x100	452G.97



	PP
200x100	452G.98



	PP
200x100	452G.99



	PP
200x100	452G.A0



	PP
200x100	452G.A1



Andere ontwerpen op aanvraag.  
Autres versions sur demande.



# GEVAARSTEKENS ISO 7010

# SIGNAUX DE DANGER ISO 7010

SIGNAUX DE DANGER ISO 7010



	PP	VIN.	VIN Refl.	Greenline	Signicolor 2mm
25mm		353C.01			
50mm		3530.01		35U0.01	
90mm	3521.01	3531.01	35R1.01	35U1.01	
150mm	352A.01	353A.01	35RA.01		
200mm	3522.01	3532.01	35R2.01	35U2.01	200x200mm 3512.01
300mm	3523.01	3533.01			
400mm	3524.01	3534.01			
500x500mm	3525.01	3535.01			



	Alu anod. 1,5mm	Alu anod. - zwarte eindakppen Alu anod. - finitions noire	Plexi 6mm (bev. inbegr) Plexi 6mm (fixations incl.)	Plexi 6mm (bevest. inbegr.) - Zijwaarts Plexi 6mm (fixations incl.) - Latéral
125x125	351B.01	35PB.01		
150x150	351A.01	35PA.01	5141.M1	5241.M1
200x200			5142.M1	5242.M1



	PP	VIN.	VIN.	PP	VIN.	VIN.
50mm		3530.96	3530.B9		3530.33	
90mm	3521.96	3531.96	3531.B9	3521.33	3531.33	3531.C1
200mm	3522.96	3532.96		3522.33	3532.33	
300mm				3523.33	3533.33	



	PP	VIN.	VIN.	PP	VIN.	VIN.	PP	VIN.
50mm		3530.68			3530.58			
90mm	3521.68	3531.68	3531.C3	3521.58	3531.58	3531.C5	3521.C0	3531.C0
200mm	3522.68	3532.68		3522.58	3532.58	3532.C5		



	PP	VIN.	PP	VIN.	VIN.	PP
50mm		3530.80		3530.71		
90mm	3521.80	3531.80	3521.71	3531.71	3531.C8	3521.F6
200mm	3522.80	3532.80		3532.71		



	PP	VIN.	VIN. Refl.	Greenline	PP	VIN.	VIN. Refl.	PP	VIN.	Alu anod. 1,5mm.
50mm		3530.32						50mm	3530.C9	
90mm	3521.32	3531.32	35R1.32		3521.62	3531.62	35R1.62	150x150mm		35A1.C9
150mm						353A.62	35RA.62	300mm	3523.C9	3533.C9
200mm	3522.32	3532.32	35R2.32	35U2.32	3522.62	3532.62				
300mm	3523.32	3533.32			3523.62	3533.62				

GEVAARSTEKENS ISO 7010

# GEVAARSTEKENS ISO 7010

# SIGNAUX DE DANGER ISO 7010



	PP	VIN.	VIN. Refl.	Greenline	Alu anod. 1,5mm	PP	VIN.	VIN. Refl.	Greenline	Alu anod. 1,5mm
50mm		3530.02					3530.04			
90mm	3521.02	3531.02	35R1.02	35U1.02		3521.04	3531.04	35R1.04	35U1.04	
125mm					351B.02					351B.04
150mm	352A.02	353A.02	35RA.02	35UA.02	351A.02	352A.04	353A.04	35RA.04	35U2.04	351A.04
200mm	3522.02	3532.02	35R2.02	35U2.02		3522.04	3532.04	35R2.04		
300mm	3523.02	3533.02				3523.04	3533.04			
400mm	3524.02	3534.02				3524.04	3534.04			



	PP	VIN.	VIN. Refl.	Greenline	PP	VIN.	Greenline	Signicolor 1,5mm	Alu anod. 1,5mm	PP	VIN.
25mm						353C.51					353C.10
50mm		3530.52				3530.51					3530.10
90mm	3521.52	3531.52	35R1.52	35U1.52	3521.51	3531.51	35U1.51			3521.10	3531.10
125mm									351B.51		352A.10
150mm			35RA.52						351A.51	3522.10	3532.10
200mm	3522.52	3532.52			3522.51	3532.51	35U2.51	3512.51		3523.10	3533.10
300mm					3523.51	3533.51		3513.51		3524.10	3534.10
400mm					3524.51	3534.51					



	PP	VIN.	VIN. Refl.	Greenline	PP	VIN.	VIN. Refl.	Greenline	PP	VIN.	VIN. Refl.	Greenline
50mm		3530.03				3530.09				3530.25		
90mm	3521.03	3531.03	35R1.03		3521.09	3531.09	35R1.09	35U1.09	3521.25	3531.25	35R1.25	
150mm	352A.03	353A.03	35RA.03		352A.09	353A.09	35RA.09		352A.25	353A.25	35RA.25	35UA.25
200mm	3522.03	3532.03	35R2.03	35U2.03	3522.09	3532.09		35U2.09	3522.25	3532.25		35U2.25
300mm	3523.03	3533.03			3523.09	3533.09			3523.25	3533.25		
400mm	3524.03	3534.03			3524.09	3534.09			3524.25	3534.25		



	PP	VIN.	VIN. Refl.	PP	VIN.	VIN. Refl.	PP	VIN.	VIN. Refl.	PP	VIN.
50mm		3530.08			3530.05			3530.24			3530.06
90mm	3521.08	3531.08	35R1.08	3521.05	3531.05		3521.24	3531.24	35R1.24	3521.06	3531.06
150mm	352A.08	353A.08	35RA.08	352A.05	353A.05	35RA.05	352A.24		35RA.24	352A.06	
200mm	3522.08	3532.08		3522.05	3532.05		3522.24	3532.24		3522.06	3532.06
300mm	3523.08	3533.08		3523.05	3533.05		3523.24	3533.24		3523.06	3533.06
400mm	3524.08	3534.08		3524.05	3534.05					3524.06	3534.06



	PP	VIN.	PP	VIN.	PP	VIN.	PP	VIN.	PP	VIN.
50mm		3530.26		3530.07		3530.27		3530.30		3530.28
90mm	3521.26	3531.26	3521.07	3531.07	3521.27	3531.27	3521.30	3531.30	3521.28	3531.28
150mm			352A.07	353A.07					352A.28	353A.28
200mm	3522.26	3532.26	3522.07	3532.07	3522.27	3532.27	3522.30	3532.30	3522.28	3532.28
300mm	3523.26	3533.26	3523.07	3533.07	3523.27	3533.27	3523.30	3533.30	3523.28	3533.28
400mm			3524.07	3534.07					3524.28	3534.28

# GEVAARSTEKENS ISO 7010

# SIGNAUX DE DANGER ISO 7010



PP	VIN.	Greenline	Signicolor 1,5mm	PP	VIN.	Vin. Ref.	PP	VIN.	PP	VIN.	
25mm	353C.46			50mm	3530.55					3530.92	
50mm	3530.46			90mm	3521.55	3531.55	35R1.55	3521.E3	3531.E3	3521.92	3531.92
90mm	3521.46	3531.46		150mm	352A.55	353A.55	35RA.55		353A.E3		353A.92
150mm				200mm	3522.55	3532.55		3522.E3	3532.E3	3522.92	3532.92
200mm	3522.46	3532.46	35U2.46	300mm	3523.55	3533.55		3523.E3	3533.E3		
300mm	3523.46			400mm	3524.55	3534.55					
400mm	3524.46										



PP	VIN.	PP	VIN.	PP	VIN.	PP	VIN.	PP	VIN.	Greenline			
25mm	353C.48	50mm	3530.N0		3530.M3		3530.99	50mm	3530.41				
50mm	3530.48	90mm	3521.N0	3531.N0	3521.M3	3531.M3	3521.99	3531.99	90mm	3521.41	3531.41	35U1.41	
90mm	3521.48	3531.48	200mm	3522.N0	3532.N0	3522.M3	3532.M3	3522.99	3532.99	150mm	352A.41	353A.41	35UA.41
200mm	3522.48	3532.48	300mm	3533.N0						200mm	3522.41	3532.41	35U2.41
300mm	3523.48	3533.48								300mm	3523.41	3533.41	



PP	VIN.	Signicolor 1,5mm	PP	VIN.	PP	VIN.	PP	VIN.	VIN.		
90mm	3521.E7	3531.E7	90mm	3531.C7	90mm	3521.M4	3531.M4	90mm	3521.M6	3531.M6	
200mm	3522.E7	3532.E7	3512.E7	200mm	3522.C7	3532.C7	150mm	353A.M4	200mm	3522.M6	3532.M6
							200mm	3522.M4	3532.M4	50mm	3530.E4
										90mm	3531.E4



PP	VIN.	PP	VIN.	PP	VIN.	PP	VIN.	PP	VIN.		
90mm	3521.N5	3531.N5	90mm	3521.M5	3531.M5	200mm	3522.A6	3532.A6	200mm	3522.N4	3532.N4
200mm	3522.N5	3532.N5	200mm	3522.M5	3532.M5				200mm	3522.N2	3532.N2

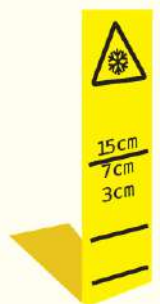

















PP	VIN.	PP	VIN.	PP	VIN.	Greenline			
200mm	3522.N3	3532.N3	90mm	3521.N6	3531.N6	50mm	3530.29		
300mm	3523.N3		200mm	3522.N6	3532.N6	90mm	3521.29	3531.29	35U1.29
						150mm	352A.29	353A.29	
						200mm	3522.29	3532.29	35U2.29
						300mm	3523.29	3533.29	
						400mm	3524.29	3534.29	

Dakrandaanduiding  
Indication bord toit

PVC-2mm		PVC-2mm	
200mm	3522.A1	100x300	3542.M0

# GEVAARSTEKENS ISO 7010

# SIGNAUX DE DANGER ISO 7010

	<b>OPGEPAST</b> Elektrische spanning		Ontvlambare stoffen		Giftige stoffen		Bijtende stoffen
PP		PP		PP		PP	
450x150mm	3526.H8	3526.H9		3526.L0		3526.L1	
	Radioactieve stoffen		Oxiderende stoffen		<b>OPGELET</b> Laserstraling		<b>OPGELET</b> Transportvoertuigen
PP		PP		PP		PP	
450x150mm	3526.L2	3526.L3		3526.H7		3526.L6	
	<b>ATTENTION</b> Tension électrique		Matières inflammables		Matières toxiques		Matières corrosives
PP		PP		PP		PP	
450x150mm	3526.L4	3526.H4		3526.H3		3526.H1	
	Matières radioactives		Matières comburantes		<b>ATTENTION</b> Rayonnement laser		<b>ATTENTION</b> Passage de chariots
PP		PP		PP		PP	
450x150mm	3526.L5	3526.H2		3526.H5		3526.H0	

ZORG VOOR EEN GOEDE PREVENTIE OP HEEL DE WERKVLOER

ASSUREZ VOUS D'UNE BONNE PREVENTION SUR TOUT LIEU DE TRAVAIL



PAG. 255



Antislip vanaf pag. 279  
Antidérapants à partir de la pag. 279



Stootbanden vanaf pag. 243  
Amortisseurs à partir de la pag. 243

# GEVAARSTEKENS

# SIGNAUX DE DANGER



	VIN.
50mm	3530.98

	PP	VIN.
150x150	3522.67	3532.67

	PP	VIN.	VIN. REFLECT.
50mm		3530.31	
90mm	3521.31	3531.31	35R1.31
150mm	352A.31	353A.31	35RA.31
200mm	3522.31	3532.31	
300mm	3523.31	3533.31	
400mm	3524.31		

	PP	VIN.	VIN. REFLECT.	Greenline
50mm		3530.21		
90mm	3521.21	3531.21	35R1.21	
150mm	352A.21	353A.21	35RA.21	35UA.21
200mm	3522.21	3532.21	35R2.21	
300mm	3523.21	3533.21		
400mm	3524.21	3534.21		



Alu anod.  
Alu anod.

	Plat	Prof.
125x125	351B.21	35PB.21
150x150	351A.21	35PA.21

	PP	VIN.
90mm	3521.89	3531.89
200mm	3522.89	3532.89
300mm	3523.89	3533.89
400mm		3534.89

	PP	VIN.
50mm		3530.81
90mm		3531.81
200mm	3522.81	3532.81
300mm	3523.81	

	PP	VIN.
50mm		3530.20
90mm	3521.20	3531.20
200mm	3522.20	3532.20
300mm	3523.20	3533.20
400mm	3524.20	3534.20

	PP	VIN.
50mm		3530.97
90mm	3521.97	3531.97



	PP	VIN.
90mm	3521.57	3531.57
200mm	3522.57	3532.57

	PP	VIN.
90mm	3521.A9	3531.A9
200mm	3522.A9	3532.A9

	PP	VIN.
90mm		3531.34
200mm	3522.34	3532.34
300mm		3533.34

	PP	VIN.
50mm		3530.43
90mm		3531.43
150mm		353A.43
200mm	3522.43	3532.43
300mm	3523.43	3533.43

	PP	VIN.
50mm		3530.42
90mm		3531.42
150mm		353A.42
200mm	3522.42	3532.42
300mm		3533.42



	VIN.
90mm	3531.M2
200mm	3532.M2

	VIN.
90mm	3531.A8
200mm	3532.A8

	PP	VIN.	VIN. REFLECT.
50x50		3530.54	
120x120	3521.54	3531.54	35R1.54
200x200	3522.54	3532.54	
400x400		3534.54	

	VIN.
90mm	3531.A4



	VIN.
50mm	3530.F0
90mm	3531.F0
200mm	3532.F0

	VIN.
50mm	3530.C6
90mm	3531.C6
200mm	3532.C6

	PP	VIN.	Signicolor 1,5mm
50mm		3530.14	
90mm	3521.14	3531.14	
150mm	352A.14		
200mm	3522.14	3532.14	3512.14
300mm	3523.14	3533.14	

	PP	VIN.
50mm		3530.50
90mm	3521.50	3531.50
150mm		353A.50
200mm	3522.50	3532.50

# GEVAARSTEKENS

# SIGNAUX DE DANGER



	PP	VIN.	Greenline
50mm		3530.40	35U0.40
90mm	3521.40	3531.40	
200mm	3522.40	3532.40	



	PP	VIN.
50mm		3530.A2
90mm	3521.A2	3531.A2
150mm		353A.A2
200mm		3532.A2



	PP	VIN.
50mm		3530.38
90mm	3521.38	3531.38
200mm	3522.38	3532.38
300mm		3533.38



	PP	VIN.
50mm		3530.39
90mm	3521.39	3531.39
200mm	3522.39	3532.39



	PP	VIN.
50mm		3530.37
90mm	3521.37	3531.37
200mm	3522.37	3532.37
300mm	3523.37	



	VIN.
50mm	3530.F9
90mm	3531.F9



	PP	VIN.
50mm		3530.15
90mm	3521.15	3531.15
200mm	3522.15	3532.15



	PP	VIN.
90mm	3521.47	3531.47
200mm	3522.47	3532.47



	PP	VIN.
50mm		3530.56
90mm		3531.56
200mm	3522.56	3532.56



	PP	VIN.
50mm		3530.12
90mm	3521.12	3531.12
200mm	3522.12	3532.12
300mm	3523.12	3533.12
400mm	3524.12	3534.12



	PP	VIN.
90mm		3531.45
200mm	3522.45	3532.45



	PP	VIN.
90mm	3521.A7	3531.A7
200mm	3522.A7	3532.A7



	PP	VIN.
90mm		3531.70
200mm	3522.70	3532.70



	PP	VIN.
90mm		3531.88
200mm		3532.88
300mm	3523.88	3533.88



	VIN.
200mm	3532.E6



	PP	VIN.
90mm	3521.J1	3531.J1
200mm	3522.J1	3532.J1
300mm	3523.J1	3533.J1



	PP	VIN.
90mm	3521.J9	3531.J9
200mm	3522.J9	3532.J9
300mm	3523.J9	3533.J9



	VIN.
50mm	3530.94
90mm	3531.94



	PP	VIN.
90mm		3531.69
200mm	3522.69	3532.69
300mm	3523.69	
400mm		3534.69



	PP	VIN.	VIN REFL.
50mm		3530.44	
90mm	3521.44	3531.44	35R1.44
150mm			35RA.44
200mm	3522.44	3532.44	
300mm	3523.44	3533.44	



	PP	VIN.
50mm		3530.53
90mm	3521.53	3531.53
200mm	3522.53	3532.53



	PP	VIN.
90mm		3531.75
200mm	3522.75	3532.75
300mm	3523.75	3533.75



	PP	VIN.
90mm		3531.78
200mm	3522.78	3532.78



	PP	VIN.
50mm		3530.59
90mm		3531.59
200mm	3522.59	3532.59
300mm	3523.59	



	PP	VIN.
50mm		3530.19
200mm	3522.19	3532.19
300mm	3523.19	3533.19
400mm	3524.19	3534.19



	VIN.
50mm	3530.95



	VIN.
50mm	3530.93
90mm	3531.93



	PP	VIN.
90mm	3521.J6	3531.J6
200mm	3522.J6	3532.J6
300mm	3523.J6	3533.J6

# GEVAARSTEKENS

# SIGNAUX DE DANGER



	PP	VIN.
90mm	3521.J0	3531.J0
200mm	3522.J0	3532.J0
300mm	3523.J0	3533.J0



	PP	VIN.
90mm	3521.J7	3531.J7
200mm	3522.J7	3532.J7
300mm	3523.J7	3533.J7



	PP	VIN.
90mm	3521.J5	3531.J5
200mm	3522.J5	3532.J5
300mm	3523.J5	3533.J5



	PP	VIN.
90mm	3521.J4	3531.J4
200mm	3522.J4	3532.J4
300mm	3523.J4	3533.J4



	PP	VIN.
90mm	3521.K5	3531.K5
200mm	3522.K5	3532.K5
300mm	3523.K5	3533.K5



	PP	VIN.
90mm	3521.J8	3531.J8
200mm	3522.J8	3532.J8
300mm	3523.J8	3533.J8



	PP	VIN.
90mm	3521.J2	3531.J2
200mm	3522.J2	3532.J2
300mm	3523.J2	3533.J2



	PP	VIN.
90mm	3521.K1	3531.K1
200mm	3522.K1	3532.K1
300mm	3523.K1	3533.K1



	PP	VIN.
90mm	3521.K6	3531.K6
200mm	3522.K6	3532.K6
300mm	3523.K6	3533.K6



	PP	VIN.
90mm	3521.K4	3531.K4
200mm	3522.K4	3532.K4
300mm	3523.K4	3533.K4



	PP	VIN.
90mm	3521.K0	3531.K0
200mm	3522.K0	3532.K0
300mm	3523.K0	3533.K0



	PP	VIN.
90mm	3521.K3	3531.K3
200mm	3522.K3	3532.K3
300mm	3523.K3	3533.K3



	PP	VIN.
90mm	3521.23	3531.23
200mm	3522.23	3532.23
300mm	3523.23	3533.23



	PP	VIN.
90mm	3521.13	3531.13
200mm	3522.13	3532.13
300mm	3523.13	3533.13
400mm	3524.13	



	PP	VIN.
50mm		3530.35
90mm	3521.35	3531.35
200mm	3522.35	3532.35
300mm	3523.35	3533.35
400mm	3524.35	3534.35



	PP	VIN.	Greenline
50mm		3530.36	
90mm	3521.36	3531.36	35U1.36
200mm	3522.36	3532.36	



	PP	VIN.
50mm		3530.16
90mm	3521.16	3531.16
200mm	3522.16	3532.16
300mm	3523.16	3533.16



	PP	VIN.	Greenline
50mm		3530.22	
90mm	3521.22	3531.22	35U1.22
150mm		353A.22	
200mm	3522.22	3532.22	
300mm	3523.22	3533.22	



	PP	VIN.
90mm	3521.J3	3531.J3
200mm	3522.J3	3532.J3
300mm	3523.J3	3533.J3



	PP	VIN.
50mm		3530.49
90mm	3521.49	3531.49
200mm	3522.49	3532.49



	VIN.
90mm	3531.E5



	VIN.
90mm	3531.E8
150mm	353A.E8



	PP	VIN.
90mm		3531.79
200mm		3532.79
300mm	3523.79	3533.79



	PP	VIN.
50mm		3530.A3
90mm		3531.A3
200mm	3522.A3	3532.A3



	PP	VIN.
50mm	3520.91	
90mm		3531.91
200mm	3522.91	3532.91
400mm	3524.91	



	PP	VIN.
90mm		3531.A5
200mm	3522.A5	3532.A5



	PP	VIN.
90mm	3521.86	3531.86
200mm		3532.86



	PP	VIN.
90mm	3521.K2	3531.K2
200mm	3522.K2	3532.K2
300mm	3523.K2	3533.K2

# GEVAARSTEKENS

# SIGNAUX DE DANGER



	PP	VIN.	VIN REFL.
50mm	3520.63	3530.63	
90mm	3521.63	3531.63	35R1.63
150mm	352A.63	353A.63	35RA.63
200mm	3522.63	3532.63	
300mm	3523.63		
400mm	3524.63		



	PP	VIN.	VIN REFL.
50mm	3520.64	3530.64	
90mm	3521.64	3531.64	35R1.64
150mm	352A.64	353A.64	35RA.64
200mm	3522.64	3532.64	
400mm	3524.64		



	PP	VIN.
150x150	3522.65	3532.65



	PP	VIN.
90mm	3521.66	3531.66
200mm	3522.66	3532.66



	PP	VIN.
90mm	3521.61	3531.61
200mm	3522.61	3532.61



	PP	VIN.
90mm	3521.60	3531.60
200mm	3522.60	3532.60



	VIN.
200mm	3532.82



	PP	VIN.
50mm		3530.11
90mm	3521.11	3531.11
200mm	3522.11	3532.11
300mm	3523.11	3533.11
400mm	3524.11	3534.11



	PP	VIN.
90mm		3531.83
200mm		3532.83
300mm	3523.83	3533.83



	PP	VIN.
90mm	3521.17	3531.17
200mm	3522.17	3532.17
300mm	3523.17	3533.17
400mm	3524.17	3534.17



	PP	VIN.
90mm	3522.87	3531.87
200mm		3532.87



	VIN.
90mm	3531.84
200mm	3532.84



	PP	VIN.
90mm	3521.90	3531.90



	PP	VIN.
200mm	3522.F5	3532.F5



	VIN.
200mm	3532.M1



	VIN.
50mm	3530.73
90mm	3531.73
200mm	3532.73



	PP	VIN.
90mm	3521.74	3531.74
200mm	3522.74	3532.74
300mm	3523.74	



	PP	VIN.
90mm	3522.85	3531.85
200mm		3532.85



	PP	VIN.
90mm		3531.F1
200mm	3522.F1	3532.F1



	PP	VIN.
90mm		3531.76
200mm	3522.76	3532.76



	VIN.
50mm	3530.E2
90mm	3531.E2
200mm	3532.E2



	PP	VIN.
50mm		3530.H6
90mm		3531.H6
200mm	3522.H6	



	PP	VIN.
90mm		3531.C2
150mm	352A.C2	



	PP	VIN.
90mm	3521.72	3531.72
200mm	3522.72	3532.72



	VIN.
90mm	3531.77
200mm	3532.77



	PP	VIN.
50mm		3530.C4
90mm	3521.C4	3531.C4



	PP	VIN.
50mm		3530.00
90mm	3521.00	3531.00
150mm		353A.00
200mm	3522.00	3532.00
300mm	3523.00	3533.00
400mm	3524.00	3534.00

# GEVAARSTEKENS-TEKSTEN

# SIGNAUX DE DANGER-TEXTES

SIGNAUX DE DANGER - TEXTES



	PP	VIN.	MAGN. 0,6mm
100x80			1700.03
200x100	1721.03	1731.03	1701.03
350x200	1722.03	1732.03	



	PP	VIN.
200x100	1721.H1	1731.H1



	PP	VIN.
200x100	1721.01	1731.01
350x200	1722.01	1732.01



	PP
200x100	1722.59
350x200	1723.59



	PP	VIN.	MAGN. 0,6mm
200x100	1721.02	1731.02	1701.02



	PP	VIN.
200x100	1721.04	1731.04
350x200	1722.04	1732.04



	PP	VIN.
350x200	1722.L9	1732.L9



	PP
200x100	1722.A1
350x200	1723.A1



	PP	VIN.
200x100	1721.A2	1731.A2
350x200	1722.A2	1732.A2



	PP	VIN.
200x100	1721.05	1731.05
350x200	1722.05	



	PP	VIN.
350x200	1722.06	1732.06



	PP	VIN.
100x50		1531.L6
350x200	1722.L8	1732.L8

	60x15mm	100x20mm	100x50mm	250x100mm
	VIN.	VIN.	VIN.	VIN.
12VOLT	1530.39		1531.86	
24VOLT	1530.01		1531.01	
110VOLT	1530.03		1531.03	
130VOLT			1531.04	
220VOLT	1530.05		1531.05	1532.05
230VOLT	1530.32		1531.32	1532.32
240VOLT			1531.27	
380VOLT	1530.07		1531.07	1532.07
400VOLT	1530.33		1531.33	1532.33
400V+N	1530.08			
440VOLT	1530.18		1531.18	
600VOLT			1531.10	
3000VOLT			1531.11	
6000VOLT			1531.17	
6300VOLT			1531.87	1532.87
10000VOLT			1531.13	1532.13
11000VOLT			1531.20	1532.20
12000VOLT			1531.14	1532.14
15000VOLT			1531.15	1532.15
230/400VOLT			1531.36	15U1.36
2x220VOLT			1531.60	
3x220VOLT			1531.06	1532.06
3x230VOLT	1530.50		1531.50	15U1.50
3x230V+PEN			1531.85	
3x380VOLT			1531.08	1532.08
3x380/220V			1531.28	1532.28
3x380V+N			1531.37	1532.37
3x400VOLT	1530.34		1531.34	15U1.34
3x400V+N			1531.35	15U1.35
3x400V+PEN			1531.84	15U1.84
DANGER		1530.86	1531.47	
GEVAAR		1530.83	1531.83	
HOOGSPANNING			1531.31	
HOOGSPANNING 15000VOLT			1531.25	
ONDER SPANNING			1531.30	
OPEN			1531.40	
GEVAAR ELEKTRISCHE SPANNING			1531.51	
DANGER TENSION ELECTRIQUE				

GEVAARSTEKENS - TEKSTEN

# EERSTE HULP BIJ ELEKTROCUTIE

België

# PREMIERS SOINS EN CAS D'ELECTROCUTION

Belgique



PP	
210x297	3823.05
297x420	3824.05



PP	
210x297	3823.06
297x420	3824.06



PP	
210x297	3823.19
297x420	3824.19



PP	
210x297	3823.09



## MACHINE RICHTLIJNEN

EG (01 - 95)

## DIRECTIVES MACHINES

CE (01 - 95)



VIN.	
90x170	3532.B0



VIN.	
90x170	3532.B1



VIN.	
90x170	3532.B2



VIN.	
90x170	3532.B3



VIN.	
90x170	3532.B4



VIN.	
90x170	3532.B5



VIN.	
90x170	3532.B6



VIN.	
90x170	3532.B7



VIN.	
90x170	3532.B8



PERMIERS SOINS EN CAS D'ELECTROCUTION & DIRECTIVES MACHINES

EERSTE HULP BIJ ELEKTROCUTIE & MACHINE RICHTLIJNEN

# MACHINE RICHTLIJNEN

# DIRECTIVES MACHINES



VIN.  
45x90 | 35C.21



VIN.  
45x90 | 35C.22



VIN.  
45x90 | 35C.23



VIN.  
45x90 | 35C.24



VIN.  
45x90 | 35C.25



VIN.  
45x90 | 35C.26



VIN.  
45x90 | 35C.27



VIN.  
45x90 | 35C.28



VIN.  
45x90 | 35C.29



VIN.  
45x90 | 35C.10



VIN.  
45x90 | 35C.11



VIN.  
45x90 | 35C.12



VIN.  
45x90 | 35C.13



VIN.  
45x90 | 35C.14



VIN.  
45x90 | 35C.15



VIN.  
45x90 | 35C.16



VIN.  
45x90 | 35C.17



VIN.  
45x90 | 35C.18



VIN.  
45x90 | 35C.19



VIN.  
45x90 | 35C.20



VIN.  
45x90 | 35C.21



VIN.  
45x90 | 35C.22



VIN.  
45x90 | 35C.23



VIN.  
45x90 | 35C.24



VIN.  
45x90 | 35C.25



VIN.  
45x90 | 35C.26



VIN.  
45x90 | 35C.27



VIN.  
45x90 | 35C.28



VIN.  
45x90 | 35C.29



VIN.  
45x90 | 35C.30



VIN.  
45x90 | 35C.31



VIN.  
45x90 | 35C.32



VIN.  
45x90 | 35C.33



VIN.  
45x90 | 35C.34



VIN.  
45x90 | 35C.35



VIN.  
45x90 | 35C.36



VIN.  
45x90 | 35C.37



VIN.  
45x90 | 35C.38



VIN.  
45x90 | 35C.39



VIN.  
45x90 | 35C.40



VIN.  
45x90 | 35C.41



VIN.  
45x90 | 35C.42

# MACHINE RICHTLIJNEN

# DIRECTIVES MACHINES



VIN.  
45x90 | 35C2.43



VIN.  
45x90 | 35C2.44



VIN.  
45x90 | 35C2.45



VIN.  
45x90 | 35C2.46



VIN.  
45x90 | 35C2.47



VIN.  
45x90 | 35C2.48



VIN.  
45x90 | 35C2.49



VIN.  
45x90 | 35C2.50



VIN.  
45x90 | 35C2.51



VIN.  
45x90 | 35C2.52



VIN.  
45x90 | 35C2.53



VIN.  
45x90 | 35C2.54



VIN.  
45x90 | 35C2.55



VIN.  
45x90 | 35C2.56



VIN.  
45x90 | 35C2.57



VIN.  
45x90 | 35C2.58



VIN.  
45x90 | 35C2.59



VIN.  
45x90 | 35C2.60



VIN.  
45x90 | 35C2.61



VIN.  
45x90 | 35C2.62



VIN.  
45x90 | 35C2.63



VIN.  
45x90 | 35C2.64

HEEFT UW BEDRIJF REEDS EEN LOCK-OUT / TAG-OUT PROCEDURE?  
VOTRE ENTREPRISE A T'ELLE DEJA UNE PROCEDURE LOCK-OUT / TAG-OUT?



**Master**  
SAFETY SERIES Lock.

PAG. 337 → 355

# COMBINATIEBORDEN

# PANNEAUX COMBINES

 **OPGELET!**  
Gevaarlijke elektrische spanning

 **AANRAKEN VERBODEN**

 **DANGER ÉLECTRIQUE**

 **DÉFENSE DE TOUCHER**

 **HOOGSPANNING LEVENSGEVAAR**

 **TOEGANG VERBODEN VOOR ONBEVOEGDEN**

 **HAUTE TENSION DANGER DE MORT**

 **ACCÈS INTERDIT À TOUTE PERSONNE ÉTRANGÈRE AU SERVICE**

 **OPGELET!**  
Gevaarlijke elektrische spanning

 **VERBODEN MIET WATER TE BLUSSEN**

 **DANGER ÉLECTRIQUE**

 **DÉFENSE D'ÉTENDRE AVEC DE L'EAU**

PP	VIN.	PP	VIN.	PP	VIN.	PP	VIN.	PP	VIN.	PP	VIN.	
300x150	1723.W0	1733.W0	1723.A0	1733.A0	1723.W1	1733.W1	1723.B0	1733.B0	1723.W2	1733.W2	1723.B9	1733.B9
450x300	1725.W0	1735.W0	1725.A0	1735.A0	1725.W1	1735.W1	1725.B0	1735.B0	1725.W2	1735.W2	1725.B9	1735.B9

 **BRANDGEVAARLIJKE STOFFEN**

 **VUUR, OPEN VLAM EN ROKEN VERBODEN**

 **MATIÈRES INFLAMMABLES**

 **FLAMME NUE INTERDITE ET DÉFENSE DE FUMER**

 **ONTVLAMBARE STOFFEN**

 **VERBODEN TE ROKEN**

 **MATIÈRES INFLAMMABLES**

 **DÉFENSE DE FUMER**

 **OPGELET!**  
Gevaren door accu's

 **VUUR, OPEN VLAM EN ROKEN VERBODEN**

 **BATTERIES SOURCE DE DANGER**

 **FLAMME NUE INTERDITE ET DÉFENSE DE FUMER**

PP	VIN.	PP	VIN.	PP	VIN.	PP	VIN.	PP	VIN.	PP	VIN.	
300x150	1723.W3	1733.W3	1723.C0	1733.C0	1723.W5	1733.W5	1723.D0	1733.D0	1723.W6	1733.W6	1723.D1	1733.D1
450x300	1725.W3	1735.W3	1725.C0	1735.C0	1725.W5	1735.W5	1725.D0	1735.D0	1725.W6	1735.W6	1725.D1	1735.D1

 **AANDACHT EXPLOSIEGEVAAR**

 **VERBODEN TE ROKEN**

 **DANGER D'EXPLOSION**

 **DÉFENSE DE FUMER**

 **GEVAAR**

 **TOEGANG VERBODEN**

 **DANGER**

 **ENTRÉE INTERDITE**

 **GEVAARLIJKE STOFFEN**

 **VEILIGHEIDSRIL VERPLICHT**

 **MATIÈRES DANGEREUSES**

 **LUNETTES DE SÉCURITÉ OBLIGATOIRES**

PP	VIN.	PP	VIN.	PP	VIN.	PP	VIN.	PP	VIN.	PP	VIN.	
300x150	1723.W7	1733.W7	1723.E0	1733.E0	1723.W8	1733.W8	1723.F0	1733.F0	1723.W9	1733.W9	1723.F4	1733.F4
450x300	1725.W7	1735.W7	1725.E0	1735.E0	1725.W8	1735.W8	1725.F0	1735.F0	1725.W9	1735.W9	1725.F4	1735.F4

 **WAARSCHUWING!**  
Geluidsniveau boven 85 dbA

 **GEHOORBESCHERMING VERPLICHT**

 **ATTENTION!**  
Niveau de bruit plus de 85 dbA

 **EQUIPEMENT ANTI-BRUIT OBLIGATOIRE**

 **OPGELET HEFRUCKS**

 **VEILIGHEIDSSCHOENEN VERPLICHT**

 **DANGER VÉHICULES DE MANUTENTION**

 **CHAUSSURES DE SÉCURITÉ OBLIGATOIRES**

 **OPGELET SLIPGEVAAR**

 **VEILIGHEIDSSCHOENEN VERPLICHT**

 **DANGER RISQUE DE DÉRAPAGE**

 **CHAUSSURES DE SÉCURITÉ OBLIGATOIRES**

PP	VIN.	PP	VIN.	PP	VIN.	PP	VIN.	PP	VIN.	PP	VIN.	
300x150	1723.X0	1733.X0	1723.G0	1733.G0	1723.X1	1733.X1	1723.G4	1733.G4	1723.X2	1733.X2	1723.H0	1733.H0
450x300	1725.X0	1735.X0	1725.G0	1735.G0	1725.X1	1735.X1	1725.G4	1735.G4	1725.X2	1735.X2	1725.H0	1735.H0

 **BIJTENDE STOFFEN**

 **VEILIGHEIDSHANDSCHOENEN VERPLICHT**

 **MATIÈRES CORROSIVES**

 **GANTS DE SÉCURITÉ OBLIGATOIRES**

 **OPGELET!**  
Biologisch besmettingsgevaar

 **VEILIGHEIDSHANDSCHOENEN VERPLICHT**

 **DANGER CONTAMINATION BIOLOGIQUE**

 **GANTS DE SÉCURITÉ OBLIGATOIRES**

 **GEVAAR**  
Radioactieve stoffen

 **ADEMHALINGS-BESCHERMING VERPLICHT**

 **MATIÈRES RADIOACTIVES**

 **PROTECTION RESPIRATOIRE OBLIGATOIRE**

PP	VIN.	PP	VIN.	PP	VIN.	PP	VIN.	PP	VIN.	PP	VIN.	
300x150	1723.X3	1733.X3	1723.H2	1733.H2	1723.X4	1733.X4	1723.M7	1733.M7	1723.X5	1733.X5	1723.Q4	1733.Q4
450x300	1725.X3	1735.X3	1725.H2	1735.H2	1725.X4	1735.X4	1725.M7	1735.M7	1725.X5	1735.X5	1725.Q4	1735.Q4

 **NIET ONDER DE LAST LOPEN**

 **VEILIGHEIDSHELM VERPLICHT**

 **NE PAS CIRCULER SOUS LA CHARGE**

 **CASQUE DE SÉCURITÉ OBLIGATOIRE**

 **GEVAAR ONDER SPANNING**

 **VOOR ELK ONDERHOUD STROOM ONDERBREKEN**

 **DANGER SOUS TENSION**

 **AVANT TOUT TRAVAIL COUPER LE COURANT**

 **GEVAAR**  
Draaiende onderdelen

 **VEILIGHEIDSAFSCHEMING VERPLICHT**

 **DANGER D'ÉCRASEMENT**

 **NE PAS ENLEVER LES PROTECTIONS**

PP	VIN.	PP	VIN.	PP	VIN.	PP	VIN.	PP	VIN.	PP	VIN.	
300x150	1723.X6	1733.X6	1723.Q5	1733.Q5	1723.X7	1733.X7	1723.Q6	1733.Q6	1723.X8	1733.X8	1723.Q7	1733.Q7
450x300	1725.X6	1735.X6	1725.Q5	1735.Q5	1725.X7	1735.X7	1725.Q6	1735.Q6	1725.X8	1735.X8	1725.Q7	1735.Q7

 **ONTVLAMBARE STOFFEN**

 **VUUR, OPEN VLAM EN ROKEN VERBODEN**

























PP	VIN.
300x150	1723.W4 1733.W4
450x300	1725.W4 1735.W4

# COMBINATIEBORDEN

## Besloten ruimten

# PANNEAUX COMBINES

## Espaces confinés

					
ANTIVALBESCHERMING VERPLICHT	ZUURSTOF- EN EXPLOESIEPROEF VERPLICHT	VUURVERGUNNING VERPLICHT	VONKVRIJ GEREEDSCHAP VERPLICHT	BRANDGEVAAR	EXPLOESIEGEVAAR
PP VIN.	PP VIN.	PP VIN.	PP VIN.	PP VIN.	PP VIN.
300x150 1723.N2 1733.N2	1723.N3 1733.N3	1723.P0 1733.P0	1723.N5 1733.N5	1723.N4 1733.N4	1723.N6 1733.N6
450x300 1725.N2 1735.N2	1725.N3 1735.N3	1725.P0 1735.P0	1725.N5 1735.N5	1725.N4 1735.N4	1725.N6 1735.N6
					
VERBODEN TE ROKEN	VUUR, OPEN VLAM EN ROKEN VERBODEN	VERBODEN TOEGANG ZONDER VERGUNNING	VERBODEN TOEGANG VOOR ONBEVOEGDEN	ADEMHALINGSBESCHERMING VERPLICHT	BESCHERMKLEDIJ VERPLICHT
PP VIN.	PP VIN.	PP VIN.	PP VIN.	PP VIN.	PP VIN.
300x150 1723.N9 1733.N9	1723.P1 1733.P1	1723.NO 1733.NO	1723.N1 1733.N1	1723.N7 1733.N7	1723.N8 1733.N8
450x300 1725.N9 1735.N9	1725.P1 1735.P1	1725.NO 1735.NO	1725.N1 1735.N1	1725.N7 1735.N7	1725.N8 1735.N8
					
DEFENSE DE FUMER	FLAMME NUE INTERDITE ET DEFENSE DE FUMER	ACCES INTERDIT SANS AUTORISATION	ENTREE INTERDITE AUX PERSONNES NON-AUTORISEES	MASQUE A GAZ OBLIGATOIRE	PROTECTION OBLIGATOIRE DU CORPS
PP VIN.	PP VIN.	PP VIN.	PP VIN.	PP VIN.	PP VIN.
300x150 1723.R9 1733.R9	1723.T1 1733.T1	1723.R0 1733.R0	1723.R1 1733.R1	1723.R7 1733.R7	1723.R8 1733.R8
450x300 1725.R9 1735.R9	1725.T1 1735.T1	1725.R0 1735.R0	1725.R1 1735.R1	1725.R7 1735.R7	1725.R8 1735.R8
					
PROTECTION INDIVIDUELLE CONTRE LES CHUTES OBLIGATOIRE	EXPLOSIOMETRE ET OXYMETRE OBLIGATOIRES	AUTORISATION DE FEU OBLIGATOIRE	MATERIEL ANTI-ETINCELLES OBLIGATOIRE	MATERIEL INFLAMMABLE	RISQUE D'EXPLOSION
PP VIN.	PP VIN.	PP VIN.	PP VIN.	PP VIN.	PP VIN.
300x150 1723.R2 1733.R2	1723.R3 1733.R3	1723.T0 1733.T0	1723.R5 1733.R5	1723.R4 1733.R4	1723.R6 1733.R6
450x300 1725.R2 1735.R2	1725.R3 1735.R3	1725.T0 1735.T0	1725.R5 1735.R5	1725.R4 1735.R4	1725.R6 1735.R6



PP	VIN.	PP	VIN.	PP	VIN.	PP	VIN.
150x300 1723.Q0 1733.Q0	1723.Q1 1733.Q1	150x300 1723.Q3 1733.Q3	150x300 1723.Q2 1733.Q2	300x450 1725.Q0 1735.Q0	300x450 1725.Q1 1735.Q1	300x450 1725.Q3 1735.Q3	300x450 1725.Q2 1735.Q2



PP	VIN.	PP	VIN.	PP	VIN.	PP	VIN.
150x300 1723.S0 1733.S0	150x300 1723.S1 1733.S1	150x300 1723.S3 1733.S3	150x300 1723.S2 1733.S2	300x450 1725.S0 1735.S0	300x450 1725.S1 1735.S1	300x450 1725.S3 1735.S3	300x450 1725.S2 1735.S2

# AANWIJZINGSTEKENS



	PP	VIN.
100x100	3621.10	3631.10
150x150	362A.10	363A.10
200x200	3622.10	3632.10



	PP	VIN.
50x50		453C.16
100x100	4520.16	4530.16
150x150	452A.16	453A.16
200x200	4522.16	4532.16



Alu anod. 1,5mm  
Alu anod. 1,5mm

	Plat
125x125	361B.10
150x150	361A.10



Alu Prof. - Zwarte eindkappen  
Alu Prof. - Finition noire

	Plat
125x125	36PB.10
150x150	36PA.10



Haaks - R/V  
En drapeau - R/V

	PVC - 1mm
200x200	3629.10



Haaks - R/V  
En drapeau - R/V

	PVC - 1mm
150x150	4571.16
200x200	4572.16



Plexi 6mm - bevestigingen inbegr.  
Plexi 6mm - fixations incl.

	Muur Mur
150x150	5141.R7
200x200	5142.R7



Plexi 6mm - Zijwaarts - bevestigingen inbegr.  
Plexi 6mm - Latéral - fixations incl.

	R/V
150x150	5241.R7
200x200	5242.R7



Plexi 6mm - bevestigingen inbegr.  
Plexi 6mm - fixations incl.

	Muur Mur
150x150	5141.V1
200x200	5142.V1



Plexi 6mm - Zijwaarts - bevestigingen inbegr.  
Plexi 6mm - Latéral - fixations incl.

	R/V
150x150	5241.V1
200x200	5242.V1



	PP	PP-R/V
200x100	452A.L8	45JA.L8
300x150	4522.L8	45J2.L8



	PP
200x100	452A.L9
300x150	4522.L9



EEN EXTRA DIMENSIE GEVEN AAN UW SIGNALISATIE?  
UNE DIMENSION SUPPLÉMENTAIRE POUR VOTRE SIGNALISATION?



Dimensionale pictogrammen vanaf pagina 141-143  
Pictogrammes dimensionnelles à partir de la page 141-143

# AANWIJZINGSTEKENS



	PP	VIN.
100x100	3621.11	3631.11
150x150	362A.11	363A.11
200x200	3622.11	3632.11

	PP	VIN.
50x50		453C.17
100x100	4520.17	4530.17
150x150	452A.17	453A.17
200x200	4522.17	4532.17

Haaks - R/V  
En drapeau - R/V

Haaks - R/V  
En drapeau - R/V

	PVC-1mm	
200x200	3629.11	

	PVC-1mm	
150x150	4571.17	
200x200	4572.17	



Alu anod.  
Alu anod.

Alu anod.  
Alu anod.

Plexi 6mm - bevestiging inbegr.  
Plexi 6mm - fixation incl.

Plexi 6mm - bevestiging inbegr.  
Plexi 6mm - fixation incl.

	Plat	Prof.
125x125	361B.11	36PB.11
150x150	361A.11	36PA.11

	Plat	Prof.
125x125	451B.17	45PB.17
150x150	451A.17	45PA.17

	Muur/Mur	Zijw.R/V Lat.R/V
150x150	5141.72	5241.72
200x200	5142.72	5242.72

	Muur/Mur	Zijw.R/V Lat.R/V
150x150	5141.M3	5241.M3
200x200	5142.M3	5242.M3



	PP	PP-R/V
200x100	452A.L0	45JA.L0
300x150	4522.L0	45J2.L0

	PP
200x100	452A.L1
300x150	4522.L1

	PP	VIN.
100x100	3621.40	3631.40
150x150	362A.40	363A.40
200x200	3622.40	3632.40

	PP	VIN.
100x100	4520.40	4530.40
150x150	452A.40	453A.40
200x200	4522.40	4532.40



Haaks - R/V  
En drapeau - R/V

Haaks - R/V  
En drapeau - R/V

Alu anod.  
Alu anod.

Alu anod.  
Alu anod.

	PVC-1mm
200x200	3629.40

	PVC-1mm
150x150	4571.40
200x200	4572.40

	Plat	Prof.
125x125	361B.40	36PB.40
150x150	361A.40	36PA.40

	Plat	Prof.
125x125	451B.40	45PB.40
150x150	451A.40	45PA.40



Plexi 6mm - bevestiging inbegr.  
Plexi 6mm - fixation incl.

	Muur/Mur	Zijw.R/V Lat.R/V
150x150	5141.83	5241.83
200x200	5142.83	5242.83

Plexi 6mm - bevestiging inbegr.  
Plexi 6mm - fixation incl.

	Muur/Mur	Zijw.R/V Lat.R/V
150x150	5141.M5	5241.M5
200x200	5142.M5	5242.M5

	PP	PP-R/V
200x100	452A.L2	45JA.L2
300x150	4522.L2	45J2.L2

	PP
200x100	452A.L3
300x150	4522.L3



	PP	VIN.
300x150	3622.91	3632.91

	PP	VIN.
300x150	3622.92	3632.92

	PP	VIN.	Spiegel- beeld VIN VIN Image réfléchie
100x100	3621.12	3631.12	
150x150	362A.12	363A.12	
200x200	3622.12	3632.12	36A2.12

	PP	VIN.
50x50		453C.19
100x100	4520.19	4530.19
150x150	452A.19	453A.19
200x200	4522.19	4532.19

# AANWIJZINGSTEKENS

# SIGNAUX D'INDICATION



Haaks - R/V  
En drapeau - R/V

	PVC - 1mm
200x200	3629.12



Haaks - R/V  
En drapeau - R/V

	PVC - 1mm
150x150	4571.19
200x200	4572.19



Alu anod.  
Alu anod.

	Plat	Prof.
125x125	361B.12	36PB.12
150x150	361A.12	36PA.12



Alu anod.  
Alu anod.

	Plat	Prof.
125x125	451B.19	45PB.19
150x150	451A.19	45PA.19



Plexi 6mm - bevestiging inbegrepen  
Plexi 6mm - fixations incluses

	Muur/Mur	Zijw.R/V Lat.R/V
150x150	5141.73	5241.73
200x200	5142.73	5242.73



Plexi 6mm - bevestiging inbegrepen  
Plexi 6mm - fixations incluses

	Muur/Mur	Zijw.R/V Lat.R/V
150x150	5141.M4	5241.M4
200x200	5142.M4	5242.M4



	PP	PP-R/V
200x100	452A.L4	45JA.L4
300x150	4522.L4	45J2.L4



	PP
200x100	452A.L5
300x150	4522.L5



	VIN.	Spiegel- beeld VIN VIN Image réfléchie
200x200	3632.32	36A2.32



	VIN.	Spiegel- beeld VIN VIN Image réfléchie
200x200	3632.33	36A2.33



	PP	VIN.
100x100	3621.F2	3631.F2
150x150	362A.F2	363A.F2



	PP	VIN.
50x50		453C.18
100x100	4520.18	4530.18
150x150	452A.18	453A.18



Haaks - R/V  
En drapeau - R/V

	PVC - 1mm
200x200	3629.F2



Haaks - R/V  
En drapeau - R/V

	PVC - 1mm
150x150	4571.18
200x200	4572.18



Alu anod.  
Alu anod.

	Plat	Prof.
125x125	361B.F2	36PB.F2
150x150	361A.F2	36PA.F2



Alu anod.  
Alu anod.

	Plat	Prof.
125x125	451B.18	45PB.18
150x150	451A.18	45PA.18



Plexi 6mm - bevestiging inbegrepen  
Plexi 6mm - fixations incluses

	Muur/Mur	Zijw.R/V Lat.R/V
150x150	5141.M6	5241.M6
200x200	5142.M6	5242.M6



Plexi 6mm - bevestiging inbegrepen  
Plexi 6mm - fixations incluses

	Muur/Mur	Zijw.R/V Lat.R/V
150x150	5141.M7	5241.M7
200x200	5142.M7	5242.M7



	PP	PP-R/V
200x100	452A.L6	45JA.L6
300x150	4522.L6	45J2.L6

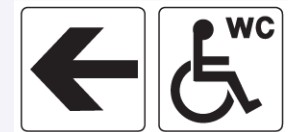

	PP
200x100	452A.L7
300x150	4522.L7



	PP	VIN.
100x100	3621.09	3631.09
150x150	362A.09	363A.09
200x200	3622.09	3632.09



	PP	VIN.
100x100	4520.15	4530.15
150x150	452A.15	453A.15



Haaks - R/V  
En drapeau - R/V

	PVC - 1mm
200x200	3629.09



Haaks - R/V  
En drapeau - R/V

	PVC - 1mm
200x200	4572.15

# AANWIJZINGSTEKENS



Alu anod.  
Alu anod.

	Plat	Prof.
125x125	361B.09	36PB.09
150x150	361A.09	36PA.09



Alu anod.  
Alu anod.

	Plat	Prof.
125x125	451B.15	45PB.15
150x150	451A.15	45PA.15



Plexi 6mm - Bevestigingen inbegr.  
Plexi 6mm - Fixations incl.

	Muur Mur	Zijw.R/V Lat.R/V
150x150	5141.70	5241.70
200x200	5142.70	5242.70



Plexi 6mm - Bevestigingen inbegr.  
Plexi 6mm - Fixations incl.

	Muur Mur	Zijw.R/V Lat.R/V
150x150	5141.M8	5241.M8
200x200	5142.M8	5242.M8

Wassen van de handen  
**VERPLICHT NA GEBRUIK**  
van toilet.

N.B. 10 DECEMBER 2022

Lavage des mains  
**OBLIGATOIRE APRES UTILISATION**  
des toilettes.

N.B. 10 DECEMBER 2022

	PP	VIN.
200x50	3622.20	3632.20
360x200	3624.20	3634.20

	PP	VIN.
200x50	3622.21	3632.21
360x200	3624.21	3634.21

	PP	VIN.
100x100	4520.20	4530.20
150x150	452A.20	453A.20
200x200	4522.20	4532.20

	PVC-1mm
150x150	4571.20
200x200	4572.20



Alu anod.  
Alu anod.

	Plat	Prof.
125x125	451B.20	45PB.20
150x150	451A.20	45PA.20



Plexi 6mm - Bevestigingen inbegr.  
Plexi 6mm - Fixations incl.

	Muur/Mur	Zijw.R/V Lat.R/V
150x150	5141.Q4	5241.Q4
200x200	5142.Q4	5242.Q4



	PP	VIN.
100x100	4520.21	4530.21
150x150	452A.21	453A.21



Haaks - R/V  
En drapeau - R/V

	PVC-1mm
150x150	4571.21
200x200	4572.21



Alu anod.  
Alu anod.

	Plat	Prof.
125x125	451B.21	45PB.21
150x150	451A.21	45PA.21



Plexi 6mm - Bevestigingen inbegr.  
Plexi 6mm - Fixations incl.

	Muur/Mur	Zijw.R/V Lat.R/V
150x150	5141.Q5	5241.Q5
200x200	5142.Q5	5242.Q5



	PP	VIN.
100x100	4520.M1	4530.M1
150x150	452A.M1	453A.M1



Haaks - R/V  
En drapeau - R/V

	PVC-1mm
150x150	4571.M1
200x200	4572.M1



Alu anod.  
Alu anod.

	Plat	Prof.
125x125	451B.M1	45PB.M1
150x150	451A.M1	45PA.M1



Plexi 6mm - Bevestigingen inbegr.  
Plexi 6mm - Fixations incl.

	Muur/Mur	Zijw.R/V Lat.R/V
150x150	5141.R1	5241.R1
200x200	5142.R1	5242.R1



	PP	VIN.
150x150	362A.F1	363A.F1



	PP	VIN.
150x150	452A.A3	453A.A3



Haaks - R/V  
En drapeau - R/V

	PVC-1mm
150x150	4571.A3
200x200	4572.A3



Alu anod.  
Alu anod.

	Plat	Prof.
125x125	451B.A3	45PB.A3
150x150	451A.A3	45PA.A3



Plexi 6mm - Bevestigingen inbegr.  
Plexi 6mm - Fixations incl.

	Muur/Mur	Zijw.R/V Lat.R/V
150x150	5141.M9	5241.M9
200x200	5142.M9	5242.M9



	PP	VIN.
150x150	362A.F0	363A.F0

# SIGNAUX D'INDICATION

# AANWIJZINGSTEKENS



	PP	VIN.
150x150	452A.A4	453A.A4



Haaks - R/V  
En drapeau - R/V

	PVC-1mm	
150x150	4571.A4	
200x200	4572.A4	



	PP	VIN.
100x100	3621.08	3631.08
150x150	362A.08	363A.08
200x200	3622.08	3632.08



	PP	VIN.
100x100	4520.29	4530.29
150x150	452A.29	453A.29
200x200	4522.29	4532.29



Plexi 6mm - Bevestigingen inbegr.  
Plexi 6mm - Fixations incl.

	Muur/Mur	Zijw. R/V Lat. R/V
150x150	5141.Q1	5241.Q1
200x200	5142.Q1	5242.Q1



	PP	VIN.
100x100	4520.30	4530.30
150x150	452A.30	453A.30



Alu anod.  
Alu anod.

	Plat	Prof.
125x125	451B.A4	45PB.A4
150x150	451A.A4	45PA.A4



Plexi 6mm - Bevestigingen inbegr.  
Plexi 6mm - Fixations incl.

	Muur/Mur	Zijw. R/V Lat. R/V
150x150	5141.Q0	5241.Q0
200x200	5142.Q0	5242.Q0



	PP	VIN.
100x100	3621.05	3631.05
200x200	3622.05	3632.05



	PP	VIN.
100x100	4520.11	4530.11
150x150	452A.11	453A.11
200x200	4522.11	4532.11



Alu anod.  
Alu anod.

	Plat	Prof.
125x125	451B.11	45PB.11
150x150	451A.11	45PA.11



Haaks - R/V  
En drapeau - R/V

	PVC-1mm	
150x150	4571.11	
200x200	4572.11	



Plexi 6mm - Bevestigingen inbegr.  
Plexi 6mm - Fixations incl.

	Muur/Mur	Zijw. R/V Lat. R/V
150x150	5141.Q2	5241.Q2
200x200	5142.Q2	5242.Q2



	PP	VIN.
100x100	3621.06	3631.06
150x150	362A.06	363A.06
200x200	3622.06	3632.06



	PP	VIN.
100x100	4520.12	4530.12
150x150	452A.12	453A.12



Haaks - R/V  
En drapeau - R/V

	PVC-1mm	
200x200	3629.06	



Haaks - R/V  
En drapeau - R/V

	PVC-1mm	
150x150	4571.12	
200x200	4572.12	



Alu anod.  
Alu anod.

	Plat	Prof.
125x125	451B.12	45PB.12
150x150	451A.12	45PA.12



Plexi 6mm - Bevestigingen inbegr.  
Plexi 6mm - Fixations incl.

	Muur/Mur	Zijw. R/V Lat. R/V
150x150	5141.Q3	5241.Q3
200x200	5142.Q3	5242.Q3



	PP	VIN.
100x100	3621.07	3631.07
150x150	362A.07	363A.07
200x200	3622.07	3632.07

# SIGNAUX D'INDICATION

# AANWIJZINGSTEKENS

# SIGNAUX D'INDICATION



Haaks - R/V  
En drapeau - R/V

	PVC - 1mm
200x200	3629.07



Haaks - R/V  
En drapeau - R/V

	PVC - 1mm
150x150	4571.13
200x200	4572.13



Alu anod.  
Alu anod.

	Plat	Prof.
125x125	451B.13	45PB.13
150x150	451A.13	45PA.13



Plexi 6mm - Bevestigingen inbegr.

Plexi 6mm - Fixations incl.

	Muur/Mur	Zijw. R/V Lat. R/V
150x150	5141. R4	5241. R4
200x200	5142. R4	5242. R4



	PP	VIN.
100x100	3621.26	3631.26
150x150	362A.26	
200x200	3622.26	



	PP	VIN.
100x100	3621.17	3631.17
200x200	3622.17	3632.17



	PP	VIN.
100x100	4520.31	4530.31
150x150	452A.31	453A.31



Haaks - R/V  
En drapeau - R/V

	PVC - 1mm
150x150	4571.31
200x200	4572.31



Alu anod.  
Alu anod.

	Plat	Prof.
125x125	451B.31	45PB.31
150x150	451A.31	45PA.31



Plexi 6mm - Bevestigingen inbegr.

Plexi 6mm - Fixations incl.

	Muur/Mur	Zijw. R/V Lat. R/V
150x150	5141. R5	5241. R5
200x200	5142. R5	5242. R5

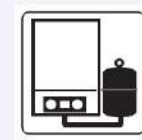

	PP	VIN.
100x100	4520. M3	4530. M3
150x150	452A. M3	453A. M3



Haaks - R/V  
En drapeau - R/V

	PVC - 1mm
150x150	4571. M3
200x200	4572. M3



Alu anod.  
Alu anod.

	Plat	Prof.
125x125	451B. M3	45PB. M3
150x150	451A. M3	45PA. M3



Plexi 6mm - Bevestigingen inbegr.

Plexi 6mm - Fixations incl.

	Muur/Mur	Zijw. R/V Lat. R/V
150x150	5141. R2	5241. R2
200x200	5142. R2	5242. R2



	PP	VIN.
100x100	4520. M2	4530. M2
150x150	452A. M2	453A. M2



Haaks - R/V  
En drapeau - R/V

	PVC - 1mm
150x150	4571. M2
200x200	4572. M2



Alu anod.  
Alu anod.

	Plat	Prof.
125x125	451B. M2	45PB. M2
150x150	451A. M2	45PA. M2



Plexi 6mm - Bevestigingen inbegr.

Plexi 6mm - Fixations incl.

	Muur/Mur	Zijw. R/V Lat. R/V
150x150	5141. R3	5241. R3
200x200	5142. R3	5242. R3



	PP	VIN.
100x100	4520.32	4530.32
150x150	452A.32	453A.32



	PP	VIN.
100x100	4520.28	4530.28
150x150	452A.28	453A.28



	PP	VIN.
100x100	4520.27	4530.27
150x150	452A.27	453A.27



Haaks - R/V  
En drapeau - R/V

	PVC - 1mm
150x150	4571.27
200x200	4572.27

	PP	VIN.
100x100	4520.33	4530.33
150x150	452A.33	453A.33

# AANWIJZINGSTEKENS



Alu anod.  
Alu anod.

	Plat	Prof.
125x125	451B.27	45PB.27
150x150	451A.27	45PA.27



Plexi 6mm - Bevestigingen inbegr.  
Plexi 6mm - Fixations incl.

	Muur/Mur	Zijw. R/V Lat. R/V
150x150	5141. R6	5241. R6
200x200	5142. R6	5242. R6



	PP	VIN.
100x100	4520.24	4530.24
150x150	452A.24	453A.24



Haaks - R/V  
En drapeau - R/V

	PVC-1mm
150x150	4571.24
200x200	4572.24



Alu anod.  
Alu anod.

	Plat	Prof.
125x125	451B.24	45PB.24
150x150	451A.24	45PA.24



Plexi 6mm - Bevestigingen inbegr.  
Plexi 6mm - Fixations incl.

	Muur/Mur	Zijw. R/V Lat. R/V
150x150	5141.06	5241.06
200x200	5142.06	5242.06



	PP	VIN.
100x100	3621.18	3631.18
200x200	3622.18	3632.18



	PP	VIN.
100x100	4520.25	4530.25
150x150	452A.25	453A.25



Haaks - R/V  
En drapeau - R/V

	PVC-1mm
150x150	4571.25
200x200	4572.25



Alu anod.  
Alu anod.

	Plat	Prof.
125x125	451B.25	45PB.25
150x150	451A.25	45PA.25



Plexi 6mm - Bevestigingen inbegr.  
Plexi 6mm - Fixations incl.

	Muur/Mur	Zijw. R/V Lat. R/V
150x150	5141.07	5241.07
200x200	5142.07	5242.07



	PP	VIN.
100x100	4520.26	4530.26
150x150	452A.26	453A.26



Alu anod.  
Alu anod.

	Plat	Prof.
125x125	451B.26	45PB.26
150x150	451A.26	45PA.26



Haaks - R/V  
En drapeau - R/V

	PVC-1mm
150x150	4571.26
200x200	4572.26



Plexi 6mm - Bevestigingen inbegr.  
Plexi 6mm - Fixations incl.

	Muur/Mur	Zijw. R/V Lat. R/V
150x150	5141.08	5241.08
200x200	5142.08	5242.08



	PP	VIN.
100x100	4520.23	4530.23
150x150	452A.23	453A.23



	PP	VIN.
100x100	3621.02	3631.02
200x200	3622.02	3632.02



	PP	VIN.
100x100	4520.10	4530.10
150x150	452A.10	453A.10
200x200	4522.10	4532.10



Haaks - R/V  
En drapeau - R/V

	PVC-1mm
200x200	3629.02



Haaks - R/V  
En drapeau - R/V

	PVC-1mm
150x150	4571.10
200x200	4572.10



	PP	VIN.
300x150	3622.90	3632.90



	PP	VIN.
150x150	362A. C1	363A. C1
200x200	3622. C1	3632. C1



	PP	VIN.
150x150	362A. C7	363A. C7
200x200	3622. C7	3632. C7



	PP	VIN.
150x150	362A. C6	363A. C6
200x200	3622. C6	3632. C6

# SIGNAUX D'INDICATION

# AANWIJZINGSTEKENS

# SIGNAUX D'INDICATION



Haaks - R/V  
En drapeau - R/V

	PP	VIN.
150x150	452A.80	453A.80
200x200	4522.80	4532.80

	PVC-1mm
150x150	4571.80
200x200	4572.80



Alu anod.  
Alu anod.

	Plat	Prof.
125x125	451B.80	45PB.80
150x150	451A.80	45PA.80



Plexi 6mm - Bevestigingen inbegr.  
Plexi 6mm - Fixations incl.

	Muur/Mur	Zijw.R/V Lat.R/V
150x150	5141.Q9	5241.Q9
200x200	5142.Q9	5242.Q9



Haaks - R/V  
En drapeau - R/V

	PP	VIN.
150x150	452A.90	453A.90
200x200	4522.90	4532.90

	PVC-1mm
150x150	4571.90
200x200	4572.90



Alu anod.  
Alu anod.

	Plat	Prof.
125x125	451B.90	45PB.90
150x150	451A.90	45PA.90



Plexi 6mm - Bevestigingen inbegr.  
Plexi 6mm - Fixations incl.

	Muur/Mur	Zijw.R/V Lat.R/V
150x150	5141.R0	5241.R0
200x200	5142.R0	5242.R0



	PP	VIN.
100x100	3621.13	3631.13
150x150	362A.13	363A.13
200x200	3622.13	3632.13

	PP	VIN.
100x100	4520.22	4530.22
150x150	452A.22	453A.22



	PP	VIN.
100x100	4520.62	4530.62
150x150	452A.62	453A.62



	PP	VIN.
150x150	362A.C0	363A.C0
200x200	3622.C0	3632.C0



	PP	VIN.
150x150	362A.C8	363A.C8
200x200	3622.C8	3632.C8

	PP	VIN.
150x150	362A.C5	363A.C5
200x200	3622.C5	3632.C5



	PP	VIN.
100x100	4520.14	4530.14
150x150	452A.14	453A.14
250x250	4523.14	4533.14



Panoram.  
Panoram.

	PVC-1mm
400x200	4525.14



	PP	VIN.
50x50	453C.39	453C.39
100x100	4520.39	4530.39
150x150	452A.39	453A.39

	VIN.
100x100	4530.37
200x200	4532.37



	PP	VIN.
100x100	3621.16	3631.16
150x150	362A.16	363A.16
200x200	3622.16	3632.16
250x250	3623.16	3633.16



R/V  
R/V

	PVC-1mm
120x120	3428.36

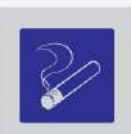

Alu anod.  
Alu anod.

	Plat	Prof.
125x125	361B.16	36PB.16
150x150	361A.16	36PA.16



ROKEN TOEGESTAAN  
PERMIS DE FUMER

	VIN.
140x200	3632.A0



	PP	VIN.
100x100	3621.23	3631.23
150x150	362A.23	363A.23
200x200	3622.23	3632.23



ROKEN  
TOEGESTAAN

	PP
210x295	3624.28

# AANWIJZINGSTEKENS

# SIGNAUX D'INDICATION

SIGNAUX D'INDICATION



	PP	VIN.
100x100	4520.34	4530.34
150x150	452A.34	453A.34

	PP	VIN.
100x100	4520.35	4530.35
150x150	452A.35	453A.35

	PP	VIN.
100x100	3621.34	3622.34
200x200	3622.34	

	PP	VIN.
100x100	3621.14	3631.14
200x200	3622.14	3632.14



plat

	PP	VIN.
100x100	3621.25	3631.25
150x150	362A.25	363A.25
200x200	3622.25	3632.25

	Alu anod.
125x125	361B.25
150x150	361A.25

	PP	VIN.
100x100	4520.52	4530.52

	PP	VIN.
100x100	4520.51	4530.51

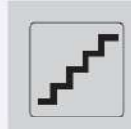
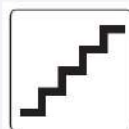

plat

	PP	VIN.
100x100	4520.54	4530.54

	PP	VIN.
100x100	4520.53	4530.53

	PP	VIN.
100x100	4520.01	4530.01
150x150	452A.01	453A.01
200x200	4522.01	4532.01

	Alu anod.
125x125	451B.01
150x150	451A.01



Haaks - R/V  
En drapeau - R/V



Haaks - R/V  
En drapeau - R/V

	PP	VIN.
100x100	3621.22	3631.22
150x150	362A.22	363A.22
200x200	3622.22	3632.22

	PVC-imm
200x200	3629.22

	PP	VIN.
100x100	3621.04	3631.04
150x150	362A.04	363A.04
200x200	3622.04	3632.04

	PVC-imm
200x200	3629.04



plat



plat

	PP	VIN.
100x100	4520.03	4530.03
150x150	452A.03	453A.03

	Alu anod.
125x125	451B.03
150x150	451A.03

	PP	VIN.
100x100	4520.02	4530.02
150x150	452A.02	453A.02

	Alu anod.
125x125	451B.02
150x150	451A.02



plat



Haaks - R/V  
En drapeau - R/V

	PP	VIN.
100x100	4520.04	4530.04
150x150	452A.04	453A.04

	Alu anod.
125x125	451B.04
150x150	451A.04

	PP	VIN.
100x100	3621.03	3631.03
150x150	362A.03	363A.03
200x200	3622.03	3632.03

	PVC-imm
200x200	3629.03

AANWIJZINGSTEKENS



PP	VIN.	
100x100	4520.05	4530.05
150x150	452A.05	453A.05
200x200	4522.05	4532.05

Alu anod.	Plat	Plat R/V
125x125	451B.05	451S.05
150x150	451A.05	451U.05

PP	VIN.	
150x150	362A.C4	363A.C4
200x200	3622.C4	3632.C4

PP	VIN.	
150x150	362A.C3	363A.C3
200x200	3622.C3	3632.C3

PP	VIN.	
150x150	362A.C2	363A.C2
200x200	3622.C2	3632.C2

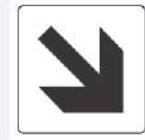

PP	VIN.	
4520.55	4520.55	4530.55
452A.95	452A.95	453A.55

PP	VIN.	
100x100	3621.01	3631.01
150x150	362A.01	363A.01
200x200	3622.01	3632.01
250x250	3623.01	

PP	VIN.	
100x100	4520.08	4530.08
150x150	452A.08	453A.08
200x200	4522.08	4532.08

Alu anod.	Plat	Plat R/V
125x125	451B.08	451S.08
150x150	451A.08	451U.08

PP	VIN.	
100x100	4520.09	4530.09
150x150	452A.09	453A.09

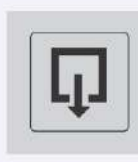

PP	VIN.	
100x100	4520.07	4530.07
150x150	452A.07	453A.07
200x200	4522.07	4532.07
250x250	4523.07	4533.07

PVC-1mm	VIN.	
150x150	4571.07	
200x200	4572.07	

PVC-1mm	VIN.	
300x150	4524.07	
400x200	4525.07	

Alu anod.	Plat	Plat R/V
125x125	451B.07	451S.07
150x150	451A.07	451U.07

Alu anod.	Haaks/Drap. R/V	
125x125	451H.07	
150x150	4511.07	

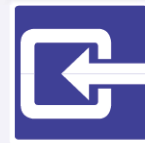
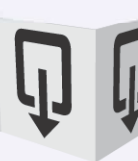

PP	VIN.	
150x150	362A.27	363A.27
200x200	3622.27	3632.27
250x250	3623.27	3633.27

PP	VIN.	
150x150	3121.07	3131.07
200x200	3122.07	3132.07
250x250	3123.07	3133.07
300x300	3124.07	
400x400	3125.07	

PVC-1mm	VIN.	
150x150	3171.07	
200x200	3172.07	

PVC-1mm	VIN.	
300x150	3124.A9	
400x200	3125.A9	

PP	VIN.	
100x100	3621.15	3631.15
200x200	3622.15	3632.15
250x250	3623.15	3633.15

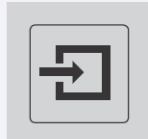
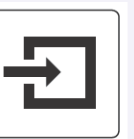

PP	VIN.	
100x100	4520.06	4530.06
150x150	452A.06	453A.06

Alu anod.	Plat	Plat R/V
125x125	451B.06	
150x150	451A.06	

PP	VIN.	
200x140	4522.51	4532.51

PP	VIN.	
200x140	4522.38	4532.38

PP	VIN.	
200x140	4522.52	4532.52



PP	VIN.	
150x150	452A.36	453A.36
200x200	4522.36	4532.36
250x250	4523.36	4533.36

Alu anod.	Plat	Plat R/V
125x125	451B.36	
150x150	451A.36	

PP	VIN.	
150x150	452A.41	453A.41
300x300	4523.41	

PP	VIN.	
150x150	452A.43	453A.43
300x300	4523.43	

PP	VIN.	
150x150	452A.45	453A.45
300x300	4523.45	

# AANWIJZINGSTEKENS

# SIGNAUX D'INDICATION



PP	VIN.	PP	VIN.	PP	VIN.	PP	VIN.	PP	VIN.		
150x150	452A.47	453A.47	150x150	452A.49	453A.49	150x150	452A.42	453A.42	150x150	452A.44	453A.44
300x300	4523.47		300x300	4523.49		300x300	4523.42		300x300	4523.44	



PP	VIN.	PP	VIN.	PP	VIN.	PP	PP
150x150	452A.48	453A.48	150x150	452A.50	453A.50	300x100	3622.19
300x300	4523.48		300x300	4523.50		400x175	3624.19
							3632.19
							3634.19
						400x300	3624.B0
						400x300	3624.29



PP	PP	PP	VIN.	VIN.	VIN.	VIN.
295x210	3624.94	295x210	3624.95	200x300	3423.29	3433.29
					90x175	363A.D0
						363A.D2
						363A.D3
						363A.D1
						363A.D4



Parkingsignalisatie vanaf pagina 227  
Signalisation parking a partir de la page 227

PP	VIN.	PP	VIN.	PP	VIN.	PP	VIN.
150x150	362A.F6	363A.F6	200x300	3623.F6	3633.F6	150x150	362A.F5
200x200	3622.F6	3632.F6	400x600	3626.F6	3636.F6	200x200	3622.F5
							3632.F5
						400x600	3626.F5
							3636.F5



	PP 1,5mm		VIN.		Alu anod.		Plexi 6mm muur - bevestigingen inbegr. Plexi 6mm mur - fixations incl.		Plexi 6mm zijw. - bevestigingen inbegr. Plexi 6mm lat. - fixations incl.	
	100x100mm	150x150mm	100x100mm	150x150mm	125x125mm	150x150mm	150x150mm	150x150mm		
Blanco	4520.00	452A.00	4530.00	453A.00	451B.00	451A.00	5141.R8	5241.R8		
-4	4520.A6	452A.A6	4530.A6	453A.A6	451B.A6	451A.A6	5141.A6	5241.A6		
-3	4520.B0	452A.B0	4530.B0	453A.B0	451B.B0	451A.B0	5141.S0	5241.S0		
-2	4520.B1	452A.B1	4530.B1	453A.B1	451B.B1	451A.B1	5141.S1	5241.S1		
-1	4520.B2	452A.B2	4530.B2	453A.B2	451B.B2	451A.B2	5141.S2	5241.S2		
0	4520.B3	452A.B3	4530.B3	453A.B3	451B.B3	451A.B3	5141.S3	5241.S3		
+1	4520.B4	452A.B4	4530.B4	453A.B4	451B.B4	451A.B4	5141.S4	5241.S4		
+2	4520.B5	452A.B5	4530.B5	453A.B5	451B.B5	451A.B5	5141.S5	5241.S5		
+3	4520.B6	452A.B6	4530.B6	453A.B6	451B.B6	451A.B6	5141.S6	5241.S6		
+4	4520.B7	452A.B7	4530.B7	453A.B7	451B.B7	451A.B7	5141.S7	5241.S7		
+5	4520.B8	452A.B8	4530.B8	453A.B8	451B.B8	451A.B8	5141.S8	5241.S8		
+6	4520.B9	452A.B9	4530.B9	453A.B9	451B.B9	451A.B9	5141.S9	5241.S9		
+7	4520.C0	452A.C0	4530.C0	453A.C0	451B.C0	451A.C0	5141.T0	5241.T0		
+8	4520.C1	452A.C1	4530.C1	453A.C1	451B.C1	451A.C1	5141.T1	5241.T1		
+9	4520.C2	452A.C2	4530.C2	453A.C2	451B.C2	451A.C2	5141.T2	5241.T2		
+10	4520.C3	452A.C3	4530.C3	453A.C3	451B.C3	451A.C3	5141.T3	5241.T3		
+11	4520.C4	452A.C4	4530.C4	453A.C4	451B.C4	451A.C4	5141.T4	5241.T4		
+12	4520.C5	452A.C5	4530.C5	453A.C5	451B.C5	451A.C5	5141.T5	5241.T5		
+13	4520.C6	452A.C6	4530.C6	453A.C6	451B.C6	451A.C6	5141.T6	5241.T6		
+14	4520.C7	452A.C7	4530.C7	453A.C7	451B.C7	451A.C7	5141.T7	5241.T7		
+15	4520.C8	452A.C8	4530.C8	453A.C8	451B.C8	451A.C8	5141.T8	5241.T8		
+16	4520.C9	452A.C9	4530.C9	453A.C9	451B.C9	451A.C9	5141.T9	5241.T9		
+17	4520.K0	452A.K0	4530.K0	453A.K0	451B.K0	451A.K0	5141.U0	5241.U0		
+18	4520.K1	452A.K1	4530.K1	453A.K1	451B.K1	451A.K1	5141.U1	5241.U1		

## INDUSTRIELE MARKERING

Gegraveerde en gefreesde borden

- Acrylaat of aluminium
- Diverse formaten en uitvoeringen

## MARQUAGE INDUSTRIELLE

Panneaux gravés et fraisés

- Acrylat ou aluminium
- Dimensions et versions différentes



## Gegraveerde merkplaatjes

Ventielplaatjes

## Plaques marquages gravées

Plaques vannes

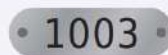

## Gepersonaliseerde eigendomsetiketten

- Gelamineerd of defragmenteerbare vinyl
- Aluminiumfolie mat zilver 40 micron
- Polyesterfolie mat zilver 25 micron
- Doming stickers

## Etiquettes propriété personnalisées

- Vinyle adhésif laminé ou défragmentable
- Film aluminium mat argenté 40 micron
- Film polyester mat argenté 25 micron
- Etiquettes doming





	153x75mm	204x100mm	47x75mm	63x100mm	42x75mm	57x100mm	82x75mm	110x100mm
Zwart/Noir	BE2.09Z	4BE3.09Z	4BE2.10Z	4BE3.10Z	4BE2.11Z	4BE3.11Z	4BE2.40Z	4BE3.40Z
Grijs/Gris	4BE2.09G	4BE3.09G	4BE2.10G	4BE3.10G	4BE2.11G	4BE3.11G	4BE2.40G	4BE3.40G
Wit/Blanc	4BE2.09W	4BE3.09W	4BE2.10W	4BE3.10W	4BE2.11W	4BE3.11W	4BE2.40W	4BE3.40W
Blauw/Bleu	4BE2.09B	4BE3.09B	4BE2.10B	4BE3.10B	4BE2.11B	4BE3.11B	4BE2.40B	4BE3.40B



	66x75mm	88x100mm	38x75mm	50x100mm	54x75mm	72x100mm	75x75mm	100x100mm
Zwart/Noir	4BE2.12Z	4BE3.12Z	4BE2.13Z	4BE3.13Z	4BE2.27Z	4BE3.27Z	4BE2.01Z	4BE3.01Z
Grijs/Gris	4BE2.12G	4BE3.12G	4BE2.13G	4BE3.13G	4BE2.27G	4BE3.27G	4BE2.01G	4BE3.01G
Wit/Blanc	4BE2.12W	4BE3.12W	4BE2.13W	4BE3.13W	4BE2.27W	4BE3.27W	4BE2.01W	4BE3.01W
Blauw/Bleu	4BE2.12B	4BE3.12B	4BE2.13B	4BE3.13B	4BE2.27B	4BE3.27B	4BE2.01B	4BE3.01B

# Welkom Vestiaire Onthaal Accueil

	323x75mm	431x100mm	325x75mm	434x100mm	297x75mm	396x100mm	286x75mm	382x100mm
Zwart/Noir	4BE4.A1Z	4BE5.A1Z	4BE4.A2Z	4BE5.A2Z	4BE4.A3Z	4BE5.A3Z	4BE4.A4Z	4BE5.A4Z
Grijs/Gris	4BE4.A1G	4BE5.A1G	4BE4.A2G	4BE5.A2G	4BE4.A3G	4BE5.A3G	4BE4.A4G	4BE5.A4G
Wit/Blanc	4BE4.A1W	4BE5.A1W	4BE4.A2W	4BE5.A2W	4BE4.A3W	4BE5.A3W	4BE4.A4W	4BE5.A4W
Blauw/Bleu	4BE4.A1B	4BE5.A1B	4BE4.A2B	4BE5.A2B	4BE4.A3B	4BE5.A3B	4BE4.A4B	4BE5.A4B

# 0 1 2 3 4 5 6 7 8 9

	75mm				100mm			
	Zwart/Noir	Grijs/Gris	Wit/Blanc	Blauw/Bleu	Zwart/Noir	Grijs/Gris	Wit/Blanc	Blauw/Bleu
-3	4BE2.70Z	4BE2.70G	4BE2.70W	4BE2.70B	4BE3.70Z	4BE3.70G	4BE3.70W	4BE3.70B
-2	4BE2.71Z	4BE2.71G	4BE2.71W	4BE2.71B	4BE3.71Z	4BE3.71G	4BE3.71W	4BE3.71B
-1	4BE2.72Z	4BE2.72G	4BE2.72W	4BE2.72B	4BE3.72Z	4BE3.72G	4BE3.72W	4BE3.72B
0	4BE2.73Z	4BE2.73G	4BE2.73W	4BE2.73B	4BE3.73Z	4BE3.73G	4BE3.73W	4BE3.73B
1	4BE2.74Z	4BE2.74G	4BE2.74W	4BE2.74B	4BE3.74Z	4BE3.74G	4BE3.74W	4BE3.74B
2	4BE2.75Z	4BE2.75G	4BE2.75W	4BE2.75B	4BE3.75Z	4BE3.75G	4BE3.75W	4BE3.75B
3	4BE2.76Z	4BE2.76G	4BE2.76W	4BE2.76B	4BE3.76Z	4BE3.76G	4BE3.76W	4BE3.76B
4	4BE2.77Z	4BE2.77G	4BE2.77W	4BE2.77B	4BE3.77Z	4BE3.77G	4BE3.77W	4BE3.77B
5	4BE2.78Z	4BE2.78G	4BE2.78W	4BE2.78B	4BE3.78Z	4BE3.78G	4BE3.78W	4BE3.78B
6	4BE2.79Z	4BE2.79G	4BE2.79W	4BE2.79B	4BE3.79Z	4BE3.79G	4BE3.79W	4BE3.79B
7	4BE2.80Z	4BE2.80G	4BE2.80W	4BE2.80B	4BE3.80Z	4BE3.80G	4BE3.80W	4BE3.80B
8	4BE2.81Z	4BE2.81G	4BE2.81W	4BE2.81B	4BE3.81Z	4BE3.81G	4BE3.81W	4BE3.81B
9	4BE2.82Z	4BE2.82G	4BE2.82W	4BE2.82B	4BE3.82Z	4BE3.82G	4BE3.82W	4BE3.82B
10	4BE2.83Z	4BE2.83G	4BE2.83W	4BE2.83B	4BE3.83Z	4BE3.83G	4BE3.83W	4BE3.83B
11	4BE2.84Z	4BE2.84G	4BE2.84W	4BE2.84B	4BE3.84Z	4BE3.84G	4BE3.84W	4BE3.84B
12	4BE2.85Z	4BE2.85G	4BE2.85W	4BE2.85B	4BE3.85Z	4BE3.85G	4BE3.85W	4BE3.85B
13	4BE2.86Z	4BE2.86G	4BE2.86W	4BE2.86B	4BE3.86Z	4BE3.86G	4BE3.86W	4BE3.86B
14	4BE2.87Z	4BE2.87G	4BE2.87W	4BE2.87B	4BE3.87Z	4BE3.87G	4BE3.87W	4BE3.87B
15	4BE2.88Z	4BE2.88G	4BE2.88W	4BE2.88B	4BE3.88Z	4BE3.88G	4BE3.88W	4BE3.88B
16	4BE2.89Z	4BE2.89G	4BE2.89W	4BE2.89B	4BE3.89Z	4BE3.89G	4BE3.89W	4BE3.89B
17	4BE2.90Z	4BE2.90G	4BE2.90W	4BE2.90B	4BE3.90Z	4BE3.90G	4BE3.90W	4BE3.90B
18	4BE2.91Z	4BE2.91G	4BE2.91W	4BE2.91B	4BE3.91Z	4BE3.91G	4BE3.91W	4BE3.91B



Andere modellen zijn mogelijk op aanvraag.  
Autres modèles sont possibles sur demande.

# CAMERABEWAKING

# SURVEILLANCE PAR CAMERA



	PP	VIN.	Spiegelbeeld VIN VIN Image réfléchie
100x100	3621.24	3631.24	36A1.24
150x150			36AA.24
200x200	3622.24	3632.24	
400x400	3624.24	3634.24	

	PP	VIN.	Spiegelbeeld VIN VIN Image réfléchie	Signicolor 1,5mm
150x200	3622.80	3632.A1	36A2.A1	3612.80
200x300	3623.80	3633.80		
400x600	3626.80	3636.80		

	PP	VIN.
400x600	3626.87	



	PP	VIN.	Spiegel- beeld VIN VIN Image réfléchie
200x300	3623.81		
400x600	3626.81	3636.81	

	PP	VIN.	Spiegel- beeld VIN VIN Image réfléchie
100x100	3621.31	3631.31	
200x200	3622.31	3632.31	36A2.31

	PP	VIN.	Spiegel- beeld VIN VIN Image réfléchie
100x100	4520.56	4530.56	
150x150	452A.56	452A.56	45AA.56

	PP	VIN.
100x100	4520.57	4530.57
150x150	452A.57	453A.57

## Camerabewaking - Wet van 21-03-07

## Surveillance par caméra - Loi du 21-03-07



	PP	VIN.	Signicolor 1,5mm	PP	VIN.	Spiegel- beeld VIN VIN Image réfléchie.	Signicolor 1,5mm
100x150	4528.58	4538.58	4518.58	100x150	4528.58MT	4538.58MT	4518.58MT
210x297	4527.58	4537.58	4517.58	210x297	4527.58MT	4537.58MT	4517.58MT
400x600	4526.58	4536.58	4516.58	400x600	4526.58MT	4536.58MT	4516.58MT



Marker - Zwart  
Marqueur - Noir  
MARK.02

**Camerabewaking-Wet v. 21-03-07**  
Verantwoordelijke: .....  
Postadres: .....  
E-mail: .....

**Camerabewaking-Wet v. 21-03-07**  
Surveillance par caméra-Loi du 21-03-07  
Verantw./ Resp.: .....  
Postadr./Adr. postale: .....  
E-mail: .....

**Surveillance par caméra-Loi du 21-03-07**  
Responsable: .....  
Adresse postale: .....  
E-mail: .....

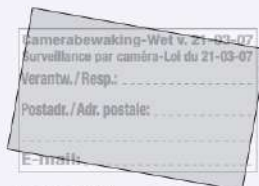

**Camerabewaking-Wet v. 21-03-07**  
Surveillance par caméra-Loi du 21-03-07  
Verantw./ Resp.: Mr. Y. X  
Postadr./Adr. postale: Verwijelstraat /  
Rue Verwijel 315 - 1000 Brussel/Bruzelles  
E-mail: info@xy.be

	VIN.
82,5x45	4530.59
165x90	453A.59
330x180	4533.59

	VIN.
82,5x45	4530.61
165x90	453A.61
330x180	4533.61

	VIN.
82,5x45	4530.60
165x90	453A.60
330x180	4533.60

**Beschermvinyl  
Vinyle de protection**

	VIN.
87,5x50	393A.01
170x95	393B.01
335x185	393C.01

**Met uw gegevens  
Avec vos coordonnées**

	VIN.
82,5x45	4530.MT
165x90	453A.MT
330x180	4533.MT

Blanco of met uw gegevens  
Blanco ou avec vos coordonnées

	TYPE 2000
400x600	K6415MTC
Paal/Poteau 2,5m	K3114
Beugels/Brides	K3104(x2)
Paaldop/Calotte	K3101



### Situatie 1 / Situation 1

De pictogrammen voor bewakingscamera's geplaatst aan de toegang van een voor het publiek toegankelijke besloten plaats, waarvan de toegang niet wordt afgebakend door een onroerend bouwwerk, hebben als afmetingen 210x297mm.  
Les pictogrammes pour des caméras de surveillance placés à l'entrée d'un lieu fermé accessible au public non délimitée par des éléments ont une dimension de 400x600mm.

Als, in een niet besloten plaats, de toegangen niet van elkaar kunnen onderscheiden worden, duidt de verantwoordelijke voor de verwerking de plaatsen aan waar de pictogrammen zullen aangebracht worden, zodat een zekere toegankelijkheid tot de informatie gegarandeerd wordt.

Lorsque dans un lieu ouvert, les entrées ne peuvent être distinguées les unes des autres, le responsable du traitement détermine les endroits où seront apposés les pictogrammes de manière à assurer une accessibilité certaine à l'information.

### Situatie 2 / Situation 2

De pictogrammen geplaatst aan de toegang van een voor het publiek toegankelijke besloten plaats, waarvan de toegang wordt afgebakend door een onroerend bouwwerk, hebben als afmetingen 210x297mm, 100x150mm.

De verantwoordelijke voor de verwerking moet erover waken dat het gekozen model van pictogram met zekerheid de informatie zichtbaar weergeeft, gelet onder meer op de breedte en de vorm van de toegang en eventueel het aantal aangebrachte exemplaren.

Les pictogrammes placés à l'entrée d'un lieu fermé accessible au public délimitée par des éléments construits et immeubles, ont une dimension de 210x297mm, 100x150mm.

Le responsable du traitement doit veiller à ce que le modèle de pictogramme retenu assure une visibilité certaine de l'information, et égard notamment à la largeur et à la configuration de l'entrée et éventuellement au nombre d'exemplaires apposés.

# CAMERABEWAKING

# SURVEILLANCE PAR CAMERA

## Vigilis bewakingsborden

## Panneaux surveillance Vigilis

### PRIVATE EN BIJZONDERE VEILIGHEID

De aanduiding van het begin en het einde van een zone op de openbare weg onder toezicht, van de mogelijkheid van uitgangscntrole bij het verlaten van situationele bevoegdheden, tot uitvoering van de wet tot regeling van de private en bijzondere veiligheid.

### SECURITE PRIVEE ET PARTICULIERE

L'indication du début et fin d'une zone de surveillance sur la voie publique, la possibilité de contrôles à la sortie d'une surface commerciale et l'exercice de compétences situationnelles, en exécution de la loi réglementant la sécurité privée et particulière.

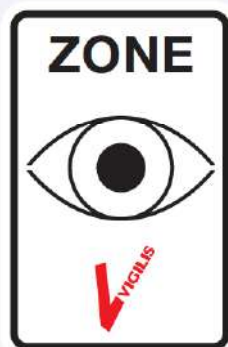

400x600mm		297x210mm	
Signicolor	4516.63	4517.63	
PP	4526.63	4527.63	
Vin	4536.63	4537.63	



400x600mm		297x210mm	
Signicolor	4516.64	4517.64	
PP	4526.64	4527.64	
Vin	4536.64	4537.64	



400x600mm		297x210mm	
Signicolor	4516.65	4517.65	
PP	4526.65	4527.65	
Vin	4536.65	4537.65	



400x600mm		297x210mm	
Signicolor	4516.66	4517.66	
PP	4526.66	4527.66	
Vin	4536.66	4537.66	

Deze borden dienen vergezeld te worden door een van onderstaande tekstborden:

Il est obligatoire de ajouter un de ces panneaux à texte :



400x200mm			
Signicolor	451D.67		
PP	452D.67		
Vin	453D.67		



400x200mm			
Signicolor	451D.71		
PP	452D.71		
Vin	453D.71		



400x200mm			
Signicolor	451D.68		
PP	452D.68		
Vin	453D.68		



400x200mm			
Signicolor	451D.72		
PP	452D.72		
Vin	453D.72		



210x150mm			
Signicolor	451K.70		
PP	452K.70		
Vin	453K.70		



210x150mm			
Signicolor	451K.74		
PP	452K.74		
Vin	453K.74		



210x100mm			
Signicolor	451K.69		
PP	452K.69		
Vin	453K.69		



210x100mm			
Signicolor	451K.73		
PP	452K.73		
Vin	453K.73		

# RECYCLAGE

# RECYCLAGE



VIN.	
150x210	3632.70
210x297	3634.70



VIN.	
150x210	3632.71
210x297	3634.71



VIN.	
150x210	3632.72
210x297	3634.72



VIN.	
150x210	3632.73
210x297	3634.73



VIN.	
150x210	3632.74
210x297	3634.74



VIN.	
150x210	3632.75
210x297	3634.75



VIN.	
150x210	3632.76
210x297	3634.76



VIN.	
150x210	3632.80
210x297	3634.80



VIN.	
150x210	3632.71
210x297	3634.71



VIN.	
150x210	3632.82
210x297	3634.82



VIN.	
150x210	3632.83
210x297	3634.83



VIN.	
150x210	3632.84
210x297	3634.84



VIN.	
150x210	3632.85
210x297	3634.85



VIN.	
150x210	3632.86
210x297	3634.86



PP	VIN.
100x100	3621.50
200x200	3632.50



PP	VIN.
100x100	3621.51
200x200	3632.51



PP	VIN.
100x100	3621.52
200x200	3632.52



PP	VIN.
100x100	3621.53
200x200	3632.53



PP	VIN.
100x100	3631.53
200x200	3632.53



PP	VIN.
100x100	3621.54
200x200	3632.54



PP	VIN.
100x100	3631.54
200x200	3632.54



PP	VIN.
150x75	3631.60



PP	VIN.
150x75	3631.61
300x150	3622.61



PP	VIN.
300x150	1722.90
	1732.90



PP	VIN.
100x100	3621.56
	3631.56



PP	VIN.
100x100	3621.57
	3631.57



PP	VIN.
300x150	3622.62
	3632.62



PP	VIN.
300x150	3622.93
	3632.93

**PMD**

**STOP! Dit is geen PMD!**

PP	VIN.
150x210	3622.H0
210x297	3624.H0
	3634.H0

Gepersonaliseerde bedrijfsinformatie over het afvalbeleid?  
Prijzen op aanvraag.  
Communication personnalisée concernant le management  
de déchets? Prix sur demande.



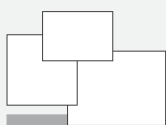

	100x100mm	200x100mm	150x150mm	200x200mm	297x210mm	300x150mm	300x300mm	400x250mm	400x300mm	420x297mm
PP wit/blanc 1,5mm	9620.00	9621.00	962A.00	9622.00	9623.00	9624.00	9625.00	9626.00	9627.00	9628.00
Alu anod. 1,5mm	9610.00	9611.00	961A.00	9612.00	9613.00	9614.00		9616.00	9617.00	9618.00
Signicolor wit/blanc 1,5mm	9670.00	9671.00	967A.00	9672.00	9673.00	9674.00	9675.00	9676.00	9677.00	9678.00
Forex wit/blanc 3mm	96E0.00	96E1.00	96EA.00	96E2.00	96E3.00	96E4.00	96E5.00	96E6.00	96E7.00	96E8.00
Magn. wit/blanc 0,6mm	9600.00	9601.00	960A.00	9602.00	9603.00	9604.00	9605.00	9606.00	9607.00	9608.00
Magn. wit/blanc 0,85mm	9660.00	9661.00	966A.00	9662.00	9663.00	9664.00	9665.00	9666.00	9667.00	9668.00



	Ø 90mm	Ø 150mm	Ø 200mm	Ø 300mm	Ø 400mm
PP wit/blanc 1,5mm	962D.00	962E.00	962F.00	962G.00	962H.00
Alu anod. 1,5mm		961E.00	961F.00		

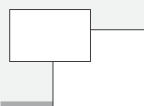

	1020x650mm	1200x1000mm
PP wit/blanc 1,5mm	9629.00	
PVC fotolum/photolum 1mm		965C.00

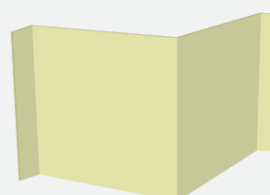

Haaks / En drapeau		Haaks / En drapeau		Panoram. / Panoram.		Panoram. / Panoram.	
PVC-1mm	PVC-1,5mm	PVC fotolum / Photolum 1mm		PVC-1mm	PVC-1,5mm	PVC	
100x100	3361.00	150x150	3081.00	200x100	332C.00	300x150	3023.00
150x150	3365.00	200x200	3082.00	200x200	3351.00	400x200	3024.00
150x450	3377.00			300x150	3324.00		
200x200	3329.00			300x300	3352.00		
200x600	3378.00			300x450	3356.00		
250x250	3362.00			400x200	3326.00		
300x300	3363.00			400x400	3353.00		
400x400	3364.00			400x600	3357.00		
				600x300	332F.00		

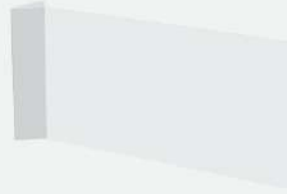

Haaks / En drapeau		Haaks / En drapeau		Haaks / En drapeau		Haaks / En drapeau	
PVC-1mm		PVC fotolum / Photolum 1mm		PVC-1mm	PVC-1,5mm	PVC fotolum / Photolum 1mm	
300x150	3172.00V	300x150	3062.00PL	300x150	3172.00H	300x150	3062.00
				400x200	3174.00		



Voor paal - Pour poteau ø 76mm

Voor paal - Pour poteau ø 51mm

Voor paal - Pour poteau ø 51mm

4D - PLAT ALU - BLANCO - 4 Zijden / faces		3D - Type 2000 - BLANCO - 3 Zijden / faces		3D - PLAT ALU - BLANCO - 3 Zijden / faces		BEUGEL-2 beugels per T2000 3D/4D bord				
Zonder folie Sans film	Wit reflect. kl. I Blanc réflect. Cl. I	Zonder folie Sans film	Wit reflect. kl. I Blanc réflect. Cl. I	Zonder folie Sans film	Wit reflect. kl. I Blanc réflect. Cl. I	BRIDE - 2 brides le panneau T2000 3D/4D				
400x400	31X3.00	31X5.00	400x400	31Y3.00	31Y5.00	400x400	31Z3.00	31Z5.00	ø51mm ø76mm	K3104 K3204

Bij de 3D en 4D bordes zijn de beugels niet inbegrepen.  
Pour les panneaux 3D et 4D les brides ne sont pas incluses.

# RAAMSTICKERS

# ADHÉSIFS VITRE

Langs de binnenzijde van het raam te kleven

À coller à la face intérieure du vitre

IMAGE REFLECHIE



150x150	31M2.05	31M2.09	31M1.56	31M1.G3	31M1.F9	31M1.G7
200x200			31M2.56	31M2.G3	31M2.F9	31M2.G7



300x100	31A8.A3	31A8.Q8	31A8.J2	31A8.G5
---------	---------	---------	---------	---------



50mm	32A0.P0	32A0.01			
90mm	32A1.P0	32A1.01	32A1.02	32A1.03	32A1.08
150mm	32AA.P0	32AA.01			32AA.08
200mm	32A2.P0	32A2.01	32A2.02		32A2.08
300mm	32A3.P0	32A3.01			



90mm	32A1.26	32A1.R1	32A1.41		32A1.20
150mm					32AA.20
200mm		32A2.R2		32A2.07	



90mm		32A1.80			
200mm	32A2.39				
140x200mm			32A2.X1	32A2.A5	32A2.57

**OPGELET**

*spiegelbeeld  
image reflexie*

**ATTENTION**

## Vogels op transfert

## Oiseaux sur transfert

200mm		
300mm		
400mm		
	Mod. 1	Mod. 2
	3536.E0	3536.E1
	3537.E0	3537.E1
	3538.E0	3538.E1



SPIEGELBEELD

# BEGELEIDING

Pictogrammen voor de zorg- en opleidingssector.  
 Voor een duidelijke herkenning en personalisatie.  
 Uitvoerbaar in diverse formaten en materialen.

# GUIDANCE

Pictogrammes pour le secteur de la santé et de l'éducation.  
 Pour une reconnaissance claire et individuelle.  
 Réalisable en différentes dimensions et matériaux.

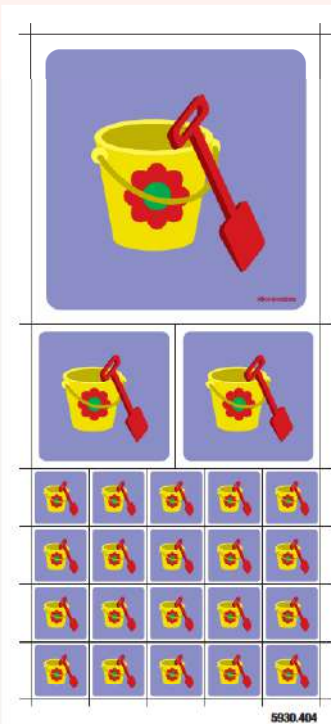

Set zelfklevers met 3 formaten:  
 Set autocollants à 3 dimensions:  
 20x 20x20mm  
 2x 50x50mm  
 1x 100x100mm

Set 5930.Nr. ...

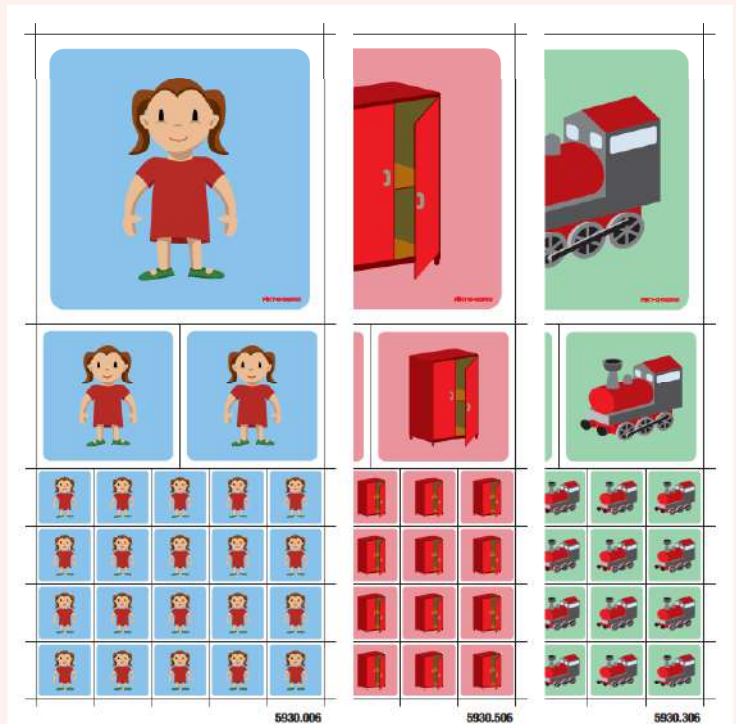

# BEGELEIDING

# GUIDANCE



	PP	VIN.	FOREX 5mm
Set		5930.001	
100x100	5921.001	5931.001	
150x150	592A.001	593A.001	
200x200	5922.001	5932.001	
400x400	5924.001	5934.001	
600x600		5936.001	5956.001



	PP	VIN.	FOREX 5mm
Set		5930.002	
100x100	5921.002	5931.002	
150x150	592A.002	593A.002	
200x200	5922.002	5932.002	
400x400	5924.002	5934.002	
600x600		5936.002	5956.002



	PP	VIN.	FOREX 5mm
Set		5930.003	
100x100	5921.003	5931.003	
150x150	592A.003	593A.003	
200x200	5922.003	5932.003	
400x400	5924.003	5934.003	
600x600		5936.003	5956.003



	PP	VIN.	FOREX 5mm
Set		5930.004	
100x100	5921.004	5931.004	
150x150	592A.004	593A.004	
200x200	5922.004	5932.004	
400x400	5924.004	5934.004	
600x600		5936.004	5956.004



	PP	VIN.	FOREX 5mm
Set		5930.005	
100x100	5921.005	5931.005	
150x150	592A.005	593A.005	
200x200	5922.005	5932.005	
400x400	5924.005	5934.005	
600x600		5936.005	5956.005



	PP	VIN.	FOREX 5mm
Set		5930.006	
100x100	5921.006	5931.006	
150x150	592A.006	593A.006	
200x200	5922.006	5932.006	
400x400	5924.006	5934.006	
600x600		5936.006	5956.006



	PP	VIN.	FOREX 5mm
Set		5930.007	
100x100	5921.007	5931.007	
150x150	592A.007	593A.007	
200x200	5922.007	5932.007	
400x400	5924.007	5934.007	
600x600		5936.007	5956.007



	PP	VIN.	FOREX 5mm
Set		5930.008	
100x100	5921.008	5931.008	
150x150	592A.008	593A.008	
200x200	5922.008	5932.008	
400x400	5924.008	5934.008	
600x600		5936.008	5956.008



	PP	VIN.	FOREX 5mm
Set		5930.101	
100x100	5921.101	5931.101	
150x150	592A.101	593A.101	
200x200	5922.101	5932.101	
400x400	5924.101	5934.101	
600x600		5936.101	5956.101



	PP	VIN.	FOREX 5mm
Set		5930.102	
100x100	5921.102	5931.102	
150x150	592A.102	593A.102	
200x200	5922.102	5932.102	
400x400	5924.102	5934.102	
600x600		5936.102	5956.102



	PP	VIN.	FOREX 5mm
Set		5930.103	
100x100	5921.103	5931.103	
150x150	592A.103	593A.103	
200x200	5922.103	5932.103	
400x400	5924.103	5934.103	
600x600		5936.103	5956.103



	PP	VIN.	FOREX 5mm
Set		5930.104	
100x100	5921.104	5931.104	
150x150	592A.104	593A.104	
200x200	5922.104	5932.104	
400x400	5924.104	5934.104	
600x600		5936.104	5956.104



	PP	VIN.	FOREX 5mm
Set		5930.105	
100x100	5921.105	5931.105	
150x150	592A.105	593A.105	
200x200	5922.105	5932.105	
400x400	5924.105	5934.105	
600x600		5936.105	5956.105



	PP	VIN.	FOREX 5mm
Set		5930.106	
100x100	5921.106	5931.106	
150x150	592A.106	593A.106	
200x200	5922.106	5932.106	
400x400	5924.106	5934.106	
600x600		5936.106	5956.106



	PP	VIN.	FOREX 5mm
Set		5930.107	
100x100	5921.107	5931.107	
150x150	592A.107	593A.107	
200x200	5922.107	5932.107	
400x400	5924.107	5934.107	
600x600		5936.107	5956.107

## BEGELEIDING



	PP	VIN.	FOREX 5mm
Set		5930.108	
100x100	5921.108	5931.108	
150x150	592A.108	593A.108	
200x200	5922.108	5932.108	
400x400	5924.108	5934.108	
600x600		5936.108	5956.108



	PP	VIN.	FOREX 5mm
Set		5930.203	
100x100	5921.203	5931.203	
150x150	592A.203	593A.203	
200x200	5922.203	5932.203	
400x400	5924.203	5934.203	
600x600		5936.203	5956.203



	PP	VIN.	FOREX 5mm
Set		5930.206	
100x100	5921.206	5931.206	
150x150	592A.206	593A.206	
200x200	5922.206	5932.206	
400x400	5924.206	5934.206	
600x600		5936.206	5956.206



	PP	VIN.	FOREX 5mm
Set		5930.301	
100x100	5921.301	5931.301	
150x150	592A.301	593A.301	
200x200	5922.301	5932.301	
400x400	5924.301	5934.301	
600x600		5936.301	5956.301



	PP	VIN.	FOREX 5mm
Set		5930.304	
100x100	5921.304	5931.304	
150x150	592A.304	593A.304	
200x200	5922.304	5932.304	
400x400	5924.304	5934.304	
600x600		5936.304	5956.304



	PP	VIN.	FOREX 5mm
Set		5930.201	
100x100	5921.201	5931.201	
150x150	592A.201	593A.201	
200x200	5922.201	5932.201	
400x400	5924.201	5934.201	
600x600		5936.201	5956.201



	PP	VIN.	FOREX 5mm
Set		5930.204	
100x100	5921.204	5931.204	
150x150	592A.204	593A.204	
200x200	5922.204	5932.204	
400x400	5924.204	5934.204	
600x600		5936.204	5956.204



	PP	VIN.	FOREX 5mm
Set		5930.207	
100x100	5921.207	5931.207	
150x150	592A.207	593A.207	
200x200	5922.207	5932.207	
400x400	5924.207	5934.207	
600x600		5936.207	5956.207



	PP	VIN.	FOREX 5mm
Set		5930.302	
100x100	5921.302	5931.302	
150x150	592A.302	593A.302	
200x200	5922.302	5932.302	
400x400	5924.302	5934.302	
600x600		5936.302	5956.302



	PP	VIN.	FOREX 5mm
Set		5930.305	
100x100	5921.305	5931.305	
150x150	592A.305	593A.305	
200x200	5922.305	5932.305	
400x400	5924.305	5934.305	
600x600		5936.305	5956.305

## GUIDANCE



	PP	VIN.	FOREX 5mm
Set		5930.202	
100x100	5921.202	5931.202	
150x150	592A.202	593A.202	
200x200	5922.202	5932.202	
400x400	5924.202	5934.202	
600x600		5936.202	5956.202



	PP	VIN.	FOREX 5mm
Set		5930.205	
100x100	5921.205	5931.205	
150x150	592A.205	593A.205	
200x200	5922.205	5932.205	
400x400	5924.205	5934.205	
600x600		5936.205	5956.205



	PP	VIN.	FOREX 5mm
Set		5930.208	
100x100	5921.208	5931.208	
150x150	592A.208	593A.208	
200x200	5922.208	5932.208	
400x400	5924.208	5934.208	
600x600		5936.208	5956.208



	PP	VIN.	FOREX 5mm
Set		5930.303	
100x100	5921.303	5931.303	
150x150	592A.303	593A.303	
200x200	5922.303	5932.303	
400x400	5924.303	5934.303	
600x600		5936.303	5956.303



	PP	VIN.	FOREX 5mm
Set		5930.306	
100x100	5921.306	5931.306	
150x150	592A.306	593A.306	
200x200	5922.306	5932.306	
400x400	5924.306	5934.306	
600x600		5936.306	5956.306

# BEGELEIDING

# GUIDANCE



	PP	VIN.	FOREX 5mm
Set		5930.307	
100x100	5921.307	5931.307	
150x150	592A.307	593A.307	
200x200	5922.307	5932.307	
400x400	5924.307	5934.307	
600x600		5936.307	5956.307



	PP	VIN.	FOREX 5mm
Set		5930.308	
100x100	5921.308	5931.308	
150x150	592A.308	593A.308	
200x200	5922.308	5932.308	
400x400	5924.308	5934.308	
600x600		5936.308	5956.308



	PP	VIN.	FOREX 5mm
Set		5930.401	
100x100	5921.401	5931.401	
150x150	592A.401	593A.401	
200x200	5922.401	5932.401	
400x400	5924.401	5934.401	
600x600		5936.401	5956.401



	PP	VIN.	FOREX 5mm
Set		5930.402	
100x100	5921.402	5931.402	
150x150	592A.402	593A.402	
200x200	5922.402	5932.402	
400x400	5924.402	5934.402	
600x600		5936.402	5956.402



	PP	VIN.	FOREX 5mm
Set		5930.403	
100x100	5921.403	5931.403	
150x150	592A.403	593A.403	
200x200	5922.403	5932.403	
400x400	5924.403	5934.403	
600x600		5936.403	5956.403



	PP	VIN.	FOREX 5mm
Set		5930.404	
100x100	5921.404	5931.404	
150x150	592A.404	593A.404	
200x200	5922.404	5932.404	
400x400	5924.404	5934.404	
600x600		5936.404	5956.404



	PP	VIN.	FOREX 5mm
Set		5930.405	
100x100	5921.405	5931.405	
150x150	592A.405	593A.405	
200x200	5922.405	5932.405	
400x400	5924.405	5934.405	
600x600		5936.405	5956.405



	PP	VIN.	FOREX 5mm
Set		5930.406	
100x100	5921.406	5931.406	
150x150	592A.406	593A.406	
200x200	5922.406	5932.406	
400x400	5924.406	5934.406	
600x600		5936.406	5956.406



	PP	VIN.	FOREX 5mm
Set		5930.407	
100x100	5921.407	5931.407	
150x150	592A.407	593A.407	
200x200	5922.407	5932.407	
400x400	5924.407	5934.407	
600x600		5936.407	5956.407



	PP	VIN.	FOREX 5mm
Set		5930.408	
100x100	5921.408	5931.408	
150x150	592A.408	593A.408	
200x200	5922.408	5932.408	
400x400	5924.408	5934.408	
600x600		5936.408	5956.408



	PP	VIN.	FOREX 5mm
Set		5930.501	
100x100	5921.501	5931.501	
150x150	592A.501	593A.501	
200x200	5922.501	5932.501	
400x400	5924.501	5934.501	
600x600		5936.501	5956.501



	PP	VIN.	FOREX 5mm
Set		5930.502	
100x100	5921.502	5931.502	
150x150	592A.502	593A.502	
200x200	5922.502	5932.502	
400x400	5924.502	5934.502	
600x600		5936.502	5956.502



	PP	VIN.	FOREX 5mm
Set		5930.503	
100x100	5921.503	5931.503	
150x150	592A.503	593A.503	
200x200	5922.503	5932.503	
400x400	5924.503	5934.503	
600x600		5936.503	5956.503



	PP	VIN.	FOREX 5mm
Set		5930.504	
100x100	5921.504	5931.504	
150x150	592A.504	593A.504	
200x200	5922.504	5932.504	
400x400	5924.504	5934.504	
600x600		5936.504	5956.504



	PP	VIN.	FOREX 5mm
Set		5930.505	
100x100	5921.505	5931.505	
150x150	592A.505	593A.505	
200x200	5922.505	5932.505	
400x400	5924.505	5934.505	
600x600		5936.505	5956.505

## BEGELEIDING



	PP	VIN.	FOREX 5mm
Set		5930.506	
100x100	5921.506	5931.506	
150x150	592A.506	593A.506	
200x200	5922.506	5932.506	
400x400	5924.506	5934.506	
600x600		5936.506	5956.506



	PP	VIN.	FOREX 5mm
Set		5930.507	
100x100	5921.507	5931.507	
150x150	592A.507	593A.507	
200x200	5922.507	5932.507	
400x400	5924.507	5934.507	
600x600		5936.507	5956.507



	PP	VIN.	FOREX 5mm
Set		5930.508	
100x100	5921.508	5931.508	
150x150	592A.508	593A.508	
200x200	5922.508	5932.508	
400x400	5924.508	5934.508	
600x600		5936.508	5956.508



	PP	VIN.	FOREX 5mm
Set		5930.601	
100x100	5921.601	5931.601	
150x150	592A.601	593A.601	
200x200	5922.601	5932.601	
400x400	5924.601	5934.601	
600x600		5936.601	5956.601



	PP	VIN.	FOREX 5mm
Set		5930.602	
100x100	5921.602	5931.602	
150x150	592A.602	593A.602	
200x200	5922.602	5932.602	
400x400	5924.602	5934.602	
600x600		5936.602	5956.602



	PP	VIN.	FOREX 5mm
Set		5930.603	
100x100	5921.603	5931.603	
150x150	592A.603	593A.603	
200x200	5922.603	5932.603	
400x400	5924.603	5934.603	
600x600		5936.603	5956.603



	PP	VIN.	FOREX 5mm
Set		5930.604	
100x100	5921.604	5931.604	
150x150	592A.604	593A.604	
200x200	5922.604	5932.604	
400x400	5924.604	5934.604	
600x600		5936.604	5956.604



	PP	VIN.	FOREX 5mm
Set		5930.605	
100x100	5921.605	5931.605	
150x150	592A.605	593A.605	
200x200	5922.605	5932.605	
400x400	5924.605	5934.605	
600x600		5936.605	5956.605



	PP	VIN.	FOREX 5mm
Set		5930.606	
100x100	5921.606	5931.606	
150x150	592A.606	593A.606	
200x200	5922.606	5932.606	
400x400	5924.606	5934.606	
600x600		5936.606	5956.606



	PP	VIN.	FOREX 5mm
Set		5930.607	
100x100	5921.607	5931.607	
150x150	592A.607	593A.607	
200x200	5922.607	5932.607	
400x400	5924.607	5934.607	
600x600		5936.607	5956.607



	PP	VIN.	FOREX 5mm
Set		5930.608	
100x100	5921.608	5931.608	
150x150	592A.608	593A.608	
200x200	5922.608	5932.608	
400x400	5924.608	5934.608	
600x600		5936.608	5956.608



	PP	VIN.	FOREX 5mm
Set		5930.701	
100x100	5921.701	5931.701	
150x150	592A.701	593A.701	
200x200	5922.701	5932.701	
400x400	5924.701	5934.701	
600x600		5936.701	5956.701



	PP	VIN.	FOREX 5mm
Set		5930.702	
100x100	5921.702	5931.702	
150x150	592A.702	593A.702	
200x200	5922.702	5932.702	
400x400	5924.702	5934.702	
600x600		5936.702	5956.702



	PP	VIN.	FOREX 5mm
Set		5930.703	
100x100	5921.703	5931.703	
150x150	592A.703	593A.703	
200x200	5922.703	5932.703	
400x400	5924.703	5934.703	
600x600		5936.703	5956.703



	PP	VIN.	FOREX 5mm
Set		5930.704	
100x100	5921.704	5931.704	
150x150	592A.704	593A.704	
200x200	5922.704	5932.704	
400x400	5924.704	5934.704	
600x600		5936.704	5956.704

## GUIDANCE

# BEGELEIDING

# GUIDANCE



	PP	VIN.	FOREX 5mm
Set		5930.705	
100x100	5921.705	5931.705	
150x150	592A.705	593A.705	
200x200	5922.705	5932.705	
400x400	5924.705	5934.705	
600x600		5936.705	5956.705



	PP	VIN.	FOREX 5mm
Set		5930.706	
100x100	5921.706	5931.706	
150x150	592A.706	593A.706	
200x200	5922.706	5932.706	
400x400	5924.706	5934.706	
600x600		5936.706	5956.706



	PP	VIN.	FOREX 5mm
Set		5930.707	
100x100	5921.707	5931.707	
150x150	592A.707	593A.707	
200x200	5922.707	5932.707	
400x400	5924.707	5934.707	
600x600		5936.707	5956.707



	PP	VIN.	FOREX 5mm
Set		5930.708	
100x100	5921.708	5931.708	
150x150	592A.708	593A.708	
200x200	5922.708	5932.708	
400x400	5924.708	5934.708	
600x600		5936.708	5956.708

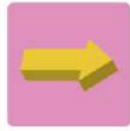

	PP	VIN.	FOREX 5mm
Set		5930.801	
100x100	5921.801	5931.801	
150x150	592A.801	593A.801	
200x200	5922.801	5932.801	
400x400	5924.801	5934.801	
600x600		5936.801	5956.801



	PP	VIN.	FOREX 5mm
Set		5930.802	
100x100	5921.802	5931.802	
150x150	592A.802	593A.802	
200x200	5922.802	5932.802	
400x400	5924.802	5934.802	
600x600		5936.802	5956.802



	PP	VIN.	FOREX 5mm
Set		5930.803	
100x100	5921.803	5931.803	
150x150	592A.803	593A.803	
200x200	5922.803	5932.803	
400x400	5924.803	5934.803	
600x600		5936.803	5956.803



	PP	VIN.	FOREX 5mm
Set		5930.804	
100x100	5921.804	5931.804	
150x150	592A.804	593A.804	
200x200	5922.804	5932.804	
400x400	5924.804	5934.804	
600x600		5936.804	5956.804



	PP	VIN.	FOREX 5mm
Set		5930.805	
100x100	5921.805	5931.805	
150x150	592A.805	593A.805	
200x200	5922.805	5932.805	
400x400	5924.805	5934.805	
600x600		5936.805	5956.805



	PP	VIN.	FOREX 5mm
Set		5930.806	
100x100	5921.806	5931.806	
150x150	592A.806	593A.806	
200x200	5922.806	5932.806	
400x400	5924.806	5934.806	
600x600		5936.806	5956.806



	PP	VIN.	FOREX 5mm
Set		5930.807	
100x100	5921.807	5931.807	
150x150	592A.807	593A.807	
200x200	5922.807	5932.807	
400x400	5924.807	5934.807	
600x600		5936.807	5956.807



	PP	VIN.	FOREX 5mm
Set		5930.808	
100x100	5921.808	5931.808	
150x150	592A.808	593A.808	
200x200	5922.808	5932.808	
400x400	5924.808	5934.808	
600x600		5936.808	5956.808



	PP	VIN.	FOREX 5mm
Set		5930.809	
100x100	5921.809	5931.809	
150x150	592A.809	593A.809	
200x200	5922.809	5932.809	
400x400	5924.809	5934.809	
600x600		5936.809	5956.809



	PP	VIN.	FOREX 5mm
Set		5930.810	
100x100	5921.810	5931.810	
150x150	592A.810	593A.810	
200x200	5922.810	5932.810	
400x400	5924.810	5934.810	
600x600		5936.810	5956.810



	PP	VIN.	FOREX 5mm
Set		5930.811	
100x100	5921.811	5931.811	
150x150	592A.811	593A.811	
200x200	5922.811	5932.811	
400x400	5924.811	5934.811	
600x600		5936.811	5956.811

## BEGELEIDING



	PP	VIN.	FOREX 5mm
Set		5930.812	
100x100	5921.812	5931.812	
150x150	592A.812	593A.812	
200x200	5922.812	5932.812	
400x400	5924.812	5934.812	
600x600		5936.812	5956.812



	PP	VIN.	FOREX 5mm
Set		5930.813	
100x100	5921.813	5931.813	
150x150	592A.813	593A.813	
200x200	5922.813	5932.813	
400x400	5924.813	5934.813	
600x600		5936.813	5956.813



	PP	VIN.	FOREX 5mm
Set		5930.814	
100x100	5921.814	5931.814	
150x150	592A.814	593A.814	
200x200	5922.814	5932.814	
400x400	5924.814	5934.814	
600x600		5936.814	5956.814



	PP	VIN.	FOREX 5mm
Set		5930.815	
100x100	5921.815	5931.815	
150x150	592A.815	593A.815	
200x200	5922.815	5932.815	
400x400	5924.815	5934.815	
600x600		5936.815	5956.815



	PP	VIN.	FOREX 5mm
Set		5930.816	
100x100	5921.816	5931.816	
150x150	592A.816	593A.816	
200x200	5922.816	5932.816	
400x400	5924.816	5934.816	
600x600		5936.816	5956.816



	PP	VIN.	FOREX 5mm
Set		5930.817	
100x100	5921.817	5931.817	
150x150	592A.817	593A.817	
200x200	5922.817	5932.817	
400x400	5924.817	5934.817	
600x600		5936.817	5956.817



	PP	VIN.	FOREX 5mm
Set		5930.818	
100x100	5921.818	5931.818	
150x150	592A.818	593A.818	
200x200	5922.818	5932.818	
400x400	5924.818	5934.818	
600x600		5936.818	5956.818



	PP	VIN.	FOREX 5mm
Set		5930.819	
100x100	5921.819	5931.819	
150x150	592A.819	593A.819	
200x200	5922.819	5932.819	
400x400	5924.819	5934.819	
600x600		5936.819	5956.819



	PP	VIN.	FOREX 5mm
Set		5930.820	
100x100	5921.820	5931.820	
150x150	592A.820	593A.820	
200x200	5922.820	5932.820	
400x400	5924.820	5934.820	
600x600		5936.820	5956.820



	PP	VIN.	FOREX 5mm
Set		5930.821	
100x100	5921.821	5931.821	
150x150	592A.821	593A.821	
200x200	5922.821	5932.821	
400x400	5924.821	5934.821	
600x600		5936.821	5956.821



	PP	VIN.	FOREX 5mm
Set		5930.822	
100x100	5921.822	5931.822	
150x150	592A.822	593A.822	
200x200	5922.822	5932.822	
400x400	5924.822	5934.822	
600x600		5936.822	5956.822



	PP	VIN.	FOREX 5mm
Set		5930.823	
100x100	5921.823	5931.823	
150x150	592A.823	593A.823	
200x200	5922.823	5932.823	
400x400	5924.823	5934.823	
600x600		5936.823	5956.823



	PP	VIN.	FOREX 5mm
Set		5930.824	
100x100	5921.824	5931.824	
150x150	592A.824	593A.824	
200x200	5922.824	5932.824	
400x400	5924.824	5934.824	
600x600		5936.824	5956.824



	PP	VIN.	FOREX 5mm
Set		5930.825	
100x100	5921.825	5931.825	
150x150	592A.825	593A.825	
200x200	5922.825	5932.825	
400x400	5924.825	5934.825	
600x600		5936.825	5956.825



	PP	VIN.	FOREX 5mm
Set		5930.826	
100x100	5921.826	5931.826	
150x150	592A.826	593A.826	
200x200	5922.826	5932.826	
400x400	5924.826	5934.826	
600x600		5936.826	5956.826

## GUIDANCE

# BEGELEIDING

# GUIDANCE



	PP	VIN.	FOREX 5mm
Set		5930.827	
100x100	5921.827	5931.827	
150x150	592A.827	593A.827	
200x200	5922.827	5932.827	
400x400	5924.827	5934.827	
600x600		5936.827	5956.827



	PP	VIN.	FOREX 5mm
Set		5930.828	
100x100	5921.828	5931.828	
150x150	592A.828	593A.828	
200x200	5922.828	5932.828	
400x400	5924.828	5934.828	
600x600		5936.828	5956.828



	PP	VIN.	FOREX 5mm
Set		5930.829	
100x100	5921.829	5931.829	
150x150	592A.829	593A.829	
200x200	5922.829	5932.829	
400x400	5924.829	5934.829	
600x600		5936.829	5956.829



	PP	VIN.	FOREX 5mm
Set		5930.830	
100x100	5921.830	5931.830	
150x150	592A.830	593A.830	
200x200	5922.830	5932.830	
400x400	5924.830	5934.830	
600x600		5936.830	5956.830



	PP	VIN.	FOREX 5mm
Set		5930.831	
100x100	5921.831	5931.831	
150x150	592A.831	593A.831	
200x200	5922.831	5932.831	
400x400	5924.831	5934.831	
600x600		5936.831	5956.831



	PP	VIN.	FOREX 5mm
Set		5930.832	
100x100	5921.832	5931.832	
150x150	592A.832	593A.832	
200x200	5922.832	5932.832	
400x400	5924.832	5934.832	
600x600		5936.832	5956.832



	PP	VIN.	FOREX 5mm
Set		5930.833	
100x100	5921.833	5931.833	
150x150	592A.833	593A.833	
200x200	5922.833	5932.833	
400x400	5924.833	5934.833	
600x600		5936.833	5956.833



	PP	VIN.	FOREX 5mm
Set		5930.834	
100x100	5921.834	5931.834	
150x150	592A.834	593A.834	
200x200	5922.834	5932.834	
400x400	5924.834	5934.834	
600x600		5936.834	5956.834



	PP	VIN.	FOREX 5mm
Set		5930.835	
100x100	5921.835	5931.835	
150x150	592A.835	593A.835	
200x200	5922.835	5932.835	
400x400	5924.835	5934.835	
600x600		5936.835	5956.835



	PP	VIN.	FOREX 5mm
Set		5930.836	
100x100	5921.836	5931.836	
150x150	592A.836	593A.836	
200x200	5922.836	5932.836	
400x400	5924.836	5934.836	
600x600		5936.836	5956.836



	PP	VIN.	FOREX 5mm
Set		5930.837	
100x100	5921.837	5931.837	
150x150	592A.837	593A.837	
200x200	5922.837	5932.837	
400x400	5924.837	5934.837	
600x600		5936.837	5956.837



	PP	VIN.	FOREX 5mm
Set		5930.838	
100x100	5921.838	5931.838	
150x150	592A.838	593A.838	
200x200	5922.838	5932.838	
400x400	5924.838	5934.838	
600x600		5936.838	5956.838



	PP	VIN.	FOREX 5mm
Set		5930.839	
100x100	5921.839	5931.839	
150x150	592A.839	593A.839	
200x200	5922.839	5932.839	
400x400	5924.839	5934.839	
600x600		5936.839	5956.839



	PP	VIN.	FOREX 5mm
Set		5930.840	
100x100	5921.840	5931.840	
150x150	592A.840	593A.840	
200x200	5922.840	5932.840	
400x400	5924.840	5934.840	
600x600		5936.840	5956.840



	PP	VIN.	FOREX 5mm
Set		5930.841	
100x100	5921.841	5931.841	
150x150	592A.841	593A.841	
200x200	5922.841	5932.841	
400x400	5924.841	5934.841	
600x600		5936.841	5956.841

## BEGELEIDING



	PP	VIN.	FOREX 5mm
Set		5930.842	
100x100	5921.842	5931.842	
150x150	592A.842	593A.842	
200x200	5922.842	5932.842	
400x400	5924.842	5934.842	
600x600		5936.842	5956.842



	PP	VIN.	FOREX 5mm
Set		5930.843	
100x100	5921.843	5931.843	
150x150	592A.843	593A.843	
200x200	5922.843	5932.843	
400x400	5924.843	5934.843	
600x600		5936.843	5956.843



	PP	VIN.	FOREX 5mm
Set		5930.844	
100x100	5921.844	5931.844	
150x150	592A.844	593A.844	
200x200	5922.844	5932.844	
400x400	5924.844	5934.844	
600x600		5936.844	5956.844



	PP	VIN.	FOREX 5mm
Set		5930.845	
100x100	5921.845	5931.845	
150x150	592A.845	593A.845	
200x200	5922.845	5932.845	
400x400	5924.845	5934.845	
600x600		5936.845	5956.845



	PP	VIN.	FOREX 5mm
Set		5930.846	
100x100	5921.846	5931.846	
150x150	592A.846	593A.846	
200x200	5922.846	5932.846	
400x400	5924.846	5934.846	
600x600		5936.846	5956.846



	PP	VIN.	FOREX 5mm
Set		5930.847	
100x100	5921.847	5931.847	
150x150	592A.847	593A.847	
200x200	5922.847	5932.847	
400x400	5924.847	5934.847	
600x600		5936.847	5956.847



	PP	VIN.	FOREX 5mm
Set		5930.848	
100x100	5921.848	5931.848	
150x150	592A.848	593A.848	
200x200	5922.848	5932.848	
400x400	5924.848	5934.848	
600x600		5936.848	5956.848



	PP	VIN.	FOREX 5mm
Set		5930.849	
100x100	5921.849	5931.849	
150x150	592A.849	593A.849	
200x200	5922.849	5932.849	
400x400	5924.849	5934.849	
600x600		5936.849	5956.849



	PP	VIN.	FOREX 5mm
Set		5930.850	
100x100	5921.850	5931.850	
150x150	592A.850	593A.850	
200x200	5922.850	5932.850	
400x400	5924.850	5934.850	
600x600		5936.850	5956.850



	PP	VIN.	FOREX 5mm
Set		5930.851	
100x100	5921.851	5931.851	
150x150	592A.851	593A.851	
200x200	5922.851	5932.851	
400x400	5924.851	5934.851	
600x600		5936.851	5956.851



	PP	VIN.	FOREX 5mm
Set		5930.852	
100x100	5921.852	5931.852	
150x150	592A.852	593A.852	
200x200	5922.852	5932.852	
400x400	5924.852	5934.852	
600x600		5936.852	5956.852



	PP	VIN.	FOREX 5mm
Set		5930.853	
100x100	5921.853	5931.853	
150x150	592A.853	593A.853	
200x200	5922.853	5932.853	
400x400	5924.853	5934.853	
600x600		5936.853	5956.853



	PP	VIN.	FOREX 5mm
Set		5930.854	
100x100	5921.854	5931.854	
150x150	592A.854	593A.854	
200x200	5922.854	5932.854	
400x400	5924.854	5934.854	
600x600		5936.854	5956.854



	PP	VIN.	FOREX 5mm
Set		5930.855	
100x100	5921.855	5931.855	
150x150	592A.855	593A.855	
200x200	5922.855	5932.855	
400x400	5924.855	5934.855	
600x600		5936.855	5956.855



	PP	VIN.	FOREX 5mm
Set		5930.856	
100x100	5921.856	5931.856	
150x150	592A.856	593A.856	
200x200	5922.856	5932.856	
400x400	5924.856	5934.856	
600x600		5936.856	5956.856

## GUIDANCE

# BEGELEIDING

# GUIDANCE



	PP	VIN.	FOREX 5mm
Set		5930.857	
100x100	5921.857	5931.857	
150x150	592A.857	593A.857	
200x200	5922.857	5932.857	
400x400	5924.857	5934.857	
600x600		5936.857	5956.857



	PP	VIN.	FOREX 5mm
Set		5930.858	
100x100	5921.858	5931.858	
150x150	592A.858	593A.858	
200x200	5922.858	5932.858	
400x400	5924.858	5934.858	
600x600		5936.858	5956.858



	PP	VIN.	FOREX 5mm
Set		5930.859	
100x100	5921.859	5931.859	
150x150	592A.859	593A.859	
200x200	5922.859	5932.859	
400x400	5924.859	5934.859	
600x600		5936.859	5956.859



	PP	VIN.	FOREX 5mm
Set		5930.860	
100x100	5921.860	5931.860	
150x150	592A.860	593A.860	
200x200	5922.860	5932.860	
400x400	5924.860	5934.860	
600x600		5936.860	5956.860



	PP	VIN.	FOREX 5mm
Set		5930.861	
100x100	5921.861	5931.861	
150x150	592A.861	593A.861	
200x200	5922.861	5932.861	
400x400	5924.861	5934.861	
600x600		5936.861	5956.861



	PP	VIN.	FOREX 5mm
Set		5930.862	
100x100	5921.862	5931.862	
150x150	592A.862	593A.862	
200x200	5922.862	5932.862	
400x400	5924.862	5934.862	
600x600		5936.862	5956.862



	PP	VIN.	FOREX 5mm
Set		5930.863	
100x100	5921.863	5931.863	
150x150	592A.863	593A.863	
200x200	5922.863	5932.863	
400x400	5924.863	5934.863	
600x600		5936.863	5956.863



	PP	VIN.	FOREX 5mm
Set		5930.864	
100x100	5921.864	5931.864	
150x150	592A.864	593A.864	
200x200	5922.864	5932.864	
400x400	5924.864	5934.864	
600x600		5936.864	5956.864



	PP	VIN.	FOREX 5mm
Set		5930.865	
100x100	5921.865	5931.865	
150x150	592A.865	593A.865	
200x200	5922.865	5932.865	
400x400	5924.865	5934.865	
600x600		5936.865	5956.865



	PP	VIN.	FOREX 5mm
Set		5930.866	
100x100	5921.866	5931.866	
150x150	592A.866	593A.866	
200x200	5922.866	5932.866	
400x400	5924.866	5934.866	
600x600		5936.866	5956.866



Met picto / tekst / kleur op aanvraag  
Avec picto / texte / couleur sur demande

	PP	VIN.	FOREX 5mm
Set		5930.MT	
100x100	5921.MT	5931.MT	
150x150	592A.MT	593A.MT	
200x200	5922.MT	5932.MT	
400x400	5924.MT	5934.MT	
600x600		5936.MT	5956.MT



4D - 4 zijden  
4D - 4 faces

	Alu Plat
400x400	31X4.MT

Voor paal - Pour poteau Ø 76mm



3D - 3 zijden  
3D - 3 faces

	Alu Plat	Type 2000
400x400	31Z4.MT	31Y4.MT

Voor paal - Pour poteau Ø 51mm



3D of 4D borden zijn ook in andere formaten leverbaar.

Panneaux 3D ou 4D sont également disponibles dans d'autres formats.

# PICTOGRAMMEN OP TRANSFER

Geleverd op drager, wat zorgt voor een snelle en eenvoudige plaatsing.  
Vinyl van een hoge kwaliteit

# PICTOGRAMMES SUR TRANSFERT

Fournis sur transfert pour une installation rapide et facile.  
Vinyile de haute qualité.



VIN. Wit / Blanc  
600x900 4836.01W



VIN. Wit / Blanc  
600x900 4836.02W



VIN. Wit / Blanc  
600x900 4836.11W



VIN. Wit / Blanc  
600x900 4836.12W



VIN. Wit / Blanc  
600x900 4836.03W



VIN. Wit / Blanc  
600x900 4836.04W



VIN. Wit / Blanc  
600x900 4836.05W



VIN. Wit / Blanc  
600x900 4836.P9W



VIN. Wit / Blanc  
600x900 4836.R0W



VIN. Wit / Blanc  
600x900 4836.R1W



VIN. Wit / Blanc  
350x820 4837.25W



VIN. Wit / Blanc  
600x619 4836.A9W



VIN. Wit / Blanc  
600x647 4838.B0W



VIN. Wit / Blanc  
600x595 4838.B1W



VIN. Rood / Rouge  
600x600 4835.B2R

Kleeffolies voor volledige deur op aanvraag  
Films adhésifs colorés, pour porte complète, sur demande

Wij produceren uw eigen ontwerp.  
Nous produisons votre propre design.

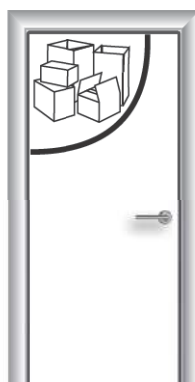

# PICTOGRAMMEN OP TRANSFER

Geleverd op drager, wat zorgt voor een snelle en eenvoudige plaatsing.  
Vinyl van een hoge kwaliteit.

# PICTOGRAMMES SUR TRANSFERT

Fournis sur transfert pour une installation rapide et facile.  
Vinyle de haute qualité.



TYPE A



TYPE B



TYPE C



TYPE D

	TYPE A 600x900mm			TYPE B 300x1500mm			TYPE C 300x945mm			TYPE D 600x600mm		
	Wit Blanc	Grijs Gris	Zwart Noir	Wit Blanc	Grijs Gris	Zwart Noir	Wit Blanc	Grijs Gris	Zwart Noir	Wit Blanc	Grijs Gris	Zwart Noir
-4	4836.39W	4836.39G	4836.39Z	4832.40W	4832.40G	4832.40Z	4833.63W	4833.63G	4833.63Z	4835.86W	4835.86G	4835.86Z
-3	4836.06W	4836.06G	4836.06Z	4832.41W	4832.41G	4832.41Z	4833.64W	4833.64G	4833.64Z	4835.87W	4835.87G	4835.87Z
-2	4836.07W	4836.07G	4836.07Z	4832.42W	4832.42G	4832.42Z	4833.65W	4833.65G	4833.65Z	4835.88W	4835.88G	4835.88Z
-1	4836.08W	4836.08G	4836.08Z	4832.43W	4832.43G	4832.43Z	4833.66W	4833.66G	4833.66Z	4835.89W	4835.89G	4835.89Z
0	4836.09W	4836.09G	4836.09Z	4832.44W	4832.44G	4832.44Z	4833.67W	4833.67G	4833.67Z	4835.90W	4835.90G	4835.90Z
+1	4836.10W	4836.10G	4836.10Z	4832.45W	4832.45G	4832.45Z	4833.68W	4833.68G	4833.68Z	4835.91W	4835.91G	4835.91Z
+2	4836.13W	4836.13G	4836.13Z	4832.46W	4832.46G	4832.46Z	4833.69W	4833.69G	4833.69Z	4835.92W	4835.92G	4835.92Z
+3	4836.14W	4836.14G	4836.14Z	4832.47W	4832.47G	4832.47Z	4833.70W	4833.70G	4833.70Z	4835.93W	4835.93G	4835.93Z
+4	4836.15W	4836.15G	4836.15Z	4832.48W	4832.48G	4832.48Z	4833.71W	4833.71G	4833.71Z	4835.94W	4835.94G	4835.94Z
+5	4836.16W	4836.16G	4836.16Z	4832.49W	4832.49G	4832.49Z	4833.72W	4833.72G	4833.72Z	4835.95W	4835.95G	4835.95Z
+6	4836.17W	4836.17G	4836.17Z	4832.50W	4832.50G	4832.50Z	4833.73W	4833.73G	4833.73Z	4835.96W	4835.96G	4835.96Z
+7	4836.18W	4836.18G	4836.18Z	4832.51W	4832.51G	4832.51Z	4833.74W	4833.74G	4833.74Z	4835.97W	4835.97G	4835.97Z
+8	4836.19W	4836.19G	4836.19Z	4832.52W	4832.52G	4832.52Z	4833.75W	4833.75G	4833.75Z	4835.98W	4835.98G	4835.98Z
+9	4836.20W	4836.20G	4836.20Z	4832.53W	4832.53G	4832.53Z	4833.76W	4833.76G	4833.76Z	4835.99W	4835.99G	4835.99Z
+10	4836.21W	4836.21G	4836.21Z	4832.54W	4832.54G	4832.54Z	4833.77W	4833.77G	4833.77Z	4835.A0W	4835.A0G	4835.A0Z
+11	4836.22W	4836.22G	4836.22Z	4832.55W	4832.55G	4832.55Z	4833.78W	4833.78G	4833.78Z	4835.A1W	4835.A1G	4835.A1Z
+12	4836.23W	4836.23G	4836.23Z	4832.56W	4832.56G	4832.56Z	4833.79W	4833.79G	4833.79Z	4835.A2W	4835.A2G	4835.A2Z
+13	4836.24W	4836.24G	4836.24Z	4832.57W	4832.57G	4832.57Z	4833.80W	4833.80G	4833.80Z	4835.A3W	4835.A3G	4835.A3Z
+14	4836.26W	4836.26G	4836.26Z	4832.58W	4832.58G	4832.58Z	4833.81W	4833.81G	4833.81Z	4835.A4W	4835.A4G	4835.A4Z
+15	4836.27W	4836.27G	4836.27Z	4832.59W	4832.59G	4832.59Z	4833.82W	4833.82G	4833.82Z	4835.A5W	4835.A5G	4835.A5Z
+16	4836.28W	4836.28G	4836.28Z	4832.60W	4832.60G	4832.60Z	4833.83W	4833.83G	4833.83Z	4835.A6W	4835.A6G	4835.A6Z
+17	4836.29W	4836.29G	4836.29Z	4832.61W	4832.61G	4832.61Z	4833.84W	4833.84G	4833.84Z	4835.A7W	4835.A7G	4835.A7Z
+18	4836.38W	4836.38G	4836.38Z	4832.62W	4832.62G	4832.62Z	4833.85W	4833.85G	4833.85Z	4835.A8W	4835.A8G	4835.A8Z

PICTOGRAMMES SUR TRANSFERT

PICTOGRAMMEN OP TRANSFER

# PICTOGRAMMEN OP TRANSFER

Geleverd op drager, wat zorgt voor een snelle en eenvoudige plaatsing.  
Vinyl van een hoge kwaliteit

# PICTOGRAMMES SUR TRANSFERT

Fournis sur transfert pour une installation rapide et facile.  
Vinyle de haute qualité.

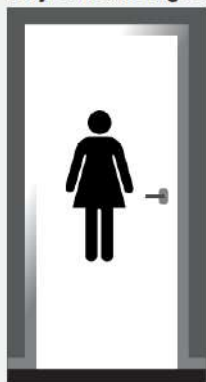

400x900

Wit-Blanc	4836.31W
Grijs-Gris	4836.31G
Zwart-Noir	4836.31Z



300x1339

Wit-Blanc	4832.34W
Grijs-Gris	4832.34G
Zwart-Noir	4832.34Z



300x1339

Wit-Blanc	4832.35W
Grijs-Gris	4832.35G
Zwart-Noir	4832.35Z

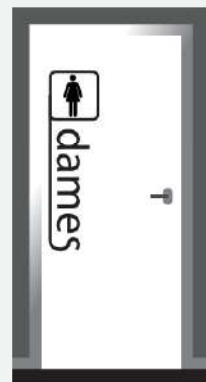

300x1084

Wit-Blanc	4833.B3W
Grijs-Gris	4833.B3G
Zwart-Noir	4833.B3Z



600x600

Wit-Blanc	4835.B4W
Grijs-Gris	4835.B4G
Zwart-Noir	4835.B4Z

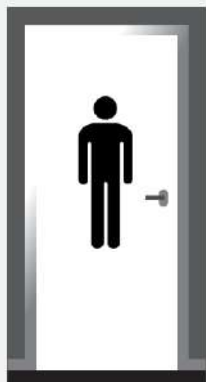

320x900

Wit-Blanc	4836.32W
Grijs-Gris	4836.32G
Zwart-Noir	4836.32Z



265x1500

Wit-Blanc	4832.36W
Grijs-Gris	4832.36G
Zwart-Noir	4832.36Z

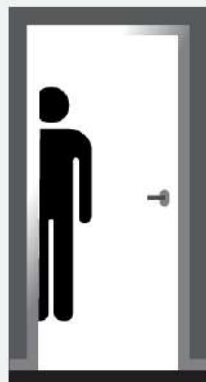

265x1500

Wit-Blanc	4832.37W
Grijs-Gris	4832.37G
Zwart-Noir	4832.37Z

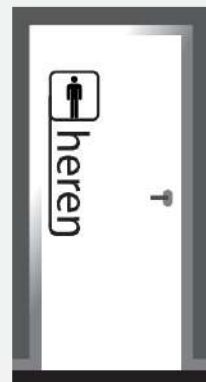

300x1000

Wit-Blanc	4833.B5W
Grijs-Gris	4833.B5G
Zwart-Noir	4833.B5Z

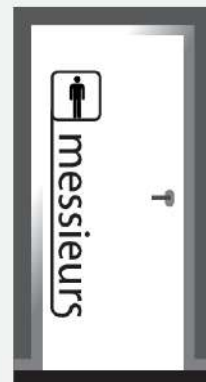

300x1500

Wit-Blanc	4832.B6W
Grijs-Gris	4832.B6G
Zwart-Noir	4832.B6Z

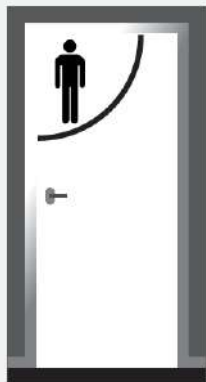

600x600

Wit-Blanc	4835.B7W
Grijs-Gris	4835.B7G
Zwart-Noir	4835.B7Z

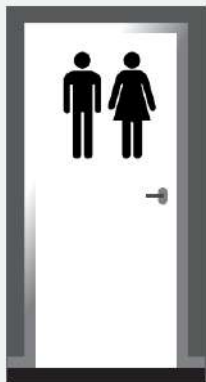

600x600

Wit-Blanc	4835.R3W
Grijs-Gris	4835.R3G
Zwart-Noir	4835.R3Z

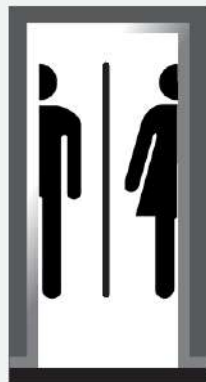

820x1500

Wit-Blanc	4839.36W
Grijs-Gris	4839.36G
Zwart-Noir	4839.36Z



300x1141

Wit-Blanc	4832.B8W
Grijs-Gris	4832.B8G
Zwart-Noir	4832.B8Z



300x1089

Wit-Blanc	4832.B9W
Grijs-Gris	4832.B9G
Zwart-Noir	4832.B9Z

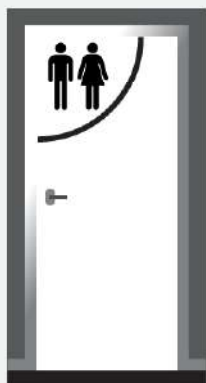

600x600

Wit-Blanc	4835.C0W
Grijs-Gris	4835.C0G
Zwart-Noir	4835.C0Z



600x744

Wit-Blanc	4836.C1W
Grijs-Gris	4836.C1G
Zwart-Noir	4836.C1Z



600x1127

Wit-Blanc	4831.C2W
Grijs-Gris	4831.C2G
Zwart-Noir	4831.C2Z



600x1127

Wit-Blanc	4831.C3W
Grijs-Gris	4831.C3G
Zwart-Noir	4831.C3Z



300x1476

Wit-Blanc	4832.C4W
Grijs-Gris	4832.C4G
Zwart-Noir	4832.C4Z

PICTOGRAMMES SUR TRANSFERT

PICTOGRAMMEN OP TRANSFER

# PICTOGRAMMEN OP TRANSFER

Geleverd op drager, wat zorgt voor een snelle en eenvoudige plaatsing.  
Vinyl van een hoge kwaliteit.

# PICTOGRAMMES SUR TRANSFERT

Fournis sur transfert pour une installation rapide et facile.  
Vynile de haute qualité.

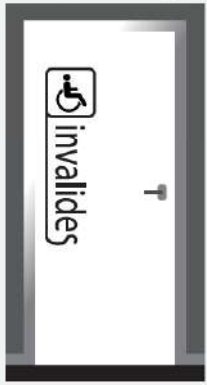

300x1062

Wit-Blanc 4832.C5W  
Grijs-Gris 4832.C5G  
Zwart-Noir 4832.C5Z

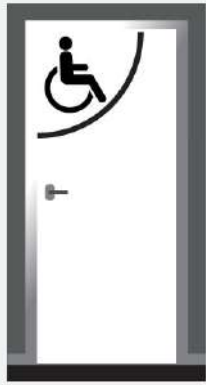

600x600

Wit-Blanc 4835.C6W  
Grijs-Gris 4835.C6G  
Zwart-Noir 4835.C6Z



600x354

Wit-Blanc 4834.30W  
Grijs-Gris 4834.30G  
Zwart-Noir 4834.30Z



600x968

Wit-Blanc 483C.C7W  
Grijs-Gris 483C.C7G  
Zwart-Noir 483C.C7Z



300x1141

Wit-Blanc 4832.C8W  
Grijs-Gris 4832.C8G  
Zwart-Noir 4832.C8Z



300x1089

Wit-Blanc 4832.C9W  
Grijs-Gris 4832.C9G  
Zwart-Noir 4832.C9Z



600x600

Wit-Blanc 4835.D0W  
Grijs-Gris 4835.D0G  
Zwart-Noir 4835.D0Z



600x529

Wit-Blanc 4835.D1W  
Grijs-Gris 4835.D1G  
Zwart-Noir 4835.D1Z



600x490

Wit-Blanc 4835.D2W  
Grijs-Gris 4835.D2G  
Zwart-Noir 4835.D2Z



300x1360

Wit-Blanc 4832.D3W  
Grijs-Gris 4832.D3G  
Zwart-Noir 4832.D3Z

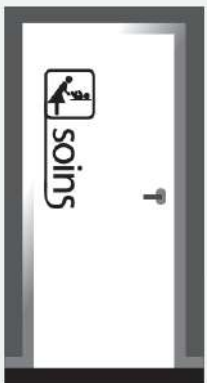

300x830

Wit-Blanc 4833.D4W  
Grijs-Gris 4833.D4G  
Zwart-Noir 4833.D4Z

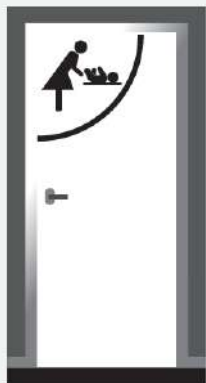

600x600

Wit-Blanc 4835.D5W  
Grijs-Gris 4835.D5G  
Zwart-Noir 4835.D5Z

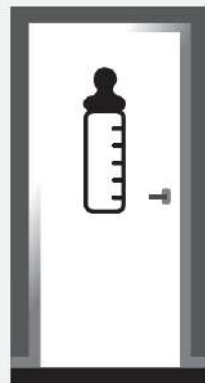

300x1000

Wit-Blanc 4833.P1W  
Grijs-Gris 4833.P1G  
Zwart-Noir 4833.P1Z



300x1500

Wit-Blanc 4832.D6W  
Grijs-Gris 4832.D6G  
Zwart-Noir 4832.D6Z

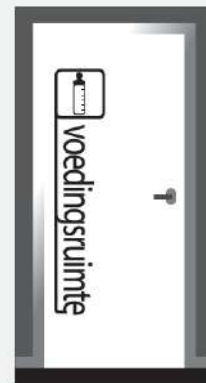

300x1500

Wit-Blanc 4832.D7W  
Grijs-Gris 4832.D7G  
Zwart-Noir 4832.D7Z

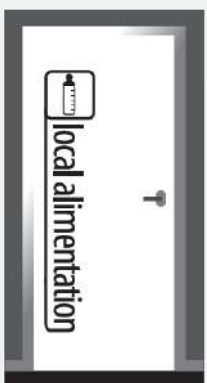

300x1562

Wit-Blanc 4832.D8W  
Grijs-Gris 4832.D8G  
Zwart-Noir 4832.D8Z

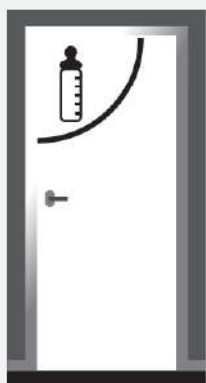

600x600

Wit-Blanc 4835.D9W  
Grijs-Gris 4835.D9G  
Zwart-Noir 4835.D9Z



600x516

Wit-Blanc 4835.E0W  
Grijs-Gris 4835.E0G  
Zwart-Noir 4835.E0Z



600x820

Wit-Blanc 4836.E1W  
Grijs-Gris 4836.E1G  
Zwart-Noir 4836.E1Z



300x1500

Wit-Blanc 4832.E2W  
Grijs-Gris 4832.E2G  
Zwart-Noir 4832.E2Z

# PICTOGRAMMEN OP TRANSFER

Geleverd op drager, wat zorgt voor een snelle en eenvoudige plaatsing.  
Vinyl van een hoge kwaliteit

# PICTOGRAMMES SUR TRANSFERT

Fournis sur transfert pour une installation rapide et facile.  
Vynile de haute qualité.

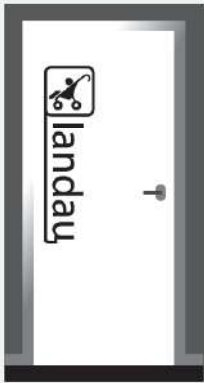

300x1064  
Wit-Blanc 4833.E3W  
Grijs-Gris 4833.E3G  
Zwart-Noir 4833.E3Z

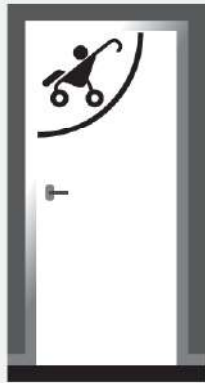

600x600  
Wit-Blanc 4835.E4W  
Grijs-Gris 4835.E4G  
Zwart-Noir 4835.E4Z



300x898  
Wit-Blanc 4833.E5W  
Grijs-Gris 4833.E5G  
Zwart-Noir 4833.E5Z



250x1500  
Wit-Blanc 4832.E6W  
Grijs-Gris 4832.E6G  
Zwart-Noir 4832.E6Z

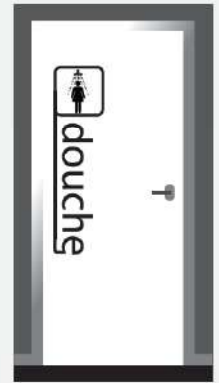

300x1129  
Wit-Blanc 4833.E7W  
Grijs-Gris 4833.E7G  
Zwart-Noir 4833.E7Z

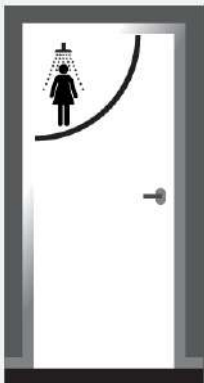

600x600  
Wit-Blanc 4835.E8W  
Grijs-Gris 4835.E8G  
Zwart-Noir 4835.E8Z

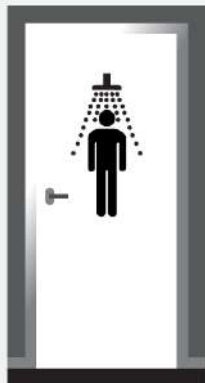

300x1000  
Wit-Blanc 4833.E9W  
Grijs-Gris 4833.E9G  
Zwart-Noir 4833.E9Z



225x1500  
Wit-Blanc 4832.F0W  
Grijs-Gris 4832.F0G  
Zwart-Noir 4832.F0Z

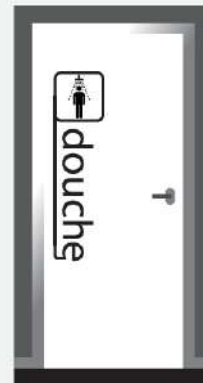

300x1129  
Wit-Blanc 4833.F1W  
Grijs-Gris 4833.F1G  
Zwart-Noir 4833.F1Z

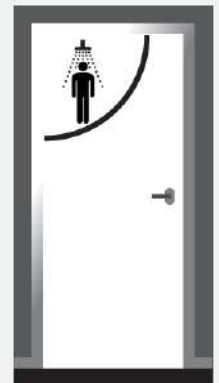

600x600  
Wit-Blanc 4835.F2W  
Grijs-Gris 4835.F2G  
Zwart-Noir 4835.F2Z



540x600  
Wit-Blanc 4835.F3W  
Grijs-Gris 4835.F3G  
Zwart-Noir 4835.F3Z



300x666  
Wit-Blanc 4838.F4W  
Grijs-Gris 4838.F4G  
Zwart-Noir 4838.F4Z

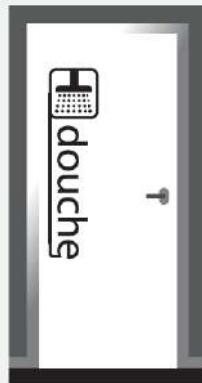

300x1129  
Wit-Blanc 4833.F5W  
Grijs-Gris 4833.F5G  
Zwart-Noir 4833.F5Z



600x600  
Wit-Blanc 4835.F6W  
Grijs-Gris 4835.F6G  
Zwart-Noir 4835.F6Z



600x437  
Wit-Blanc 4835.F7W  
Grijs-Gris 4835.F7G  
Zwart-Noir 4835.F7Z

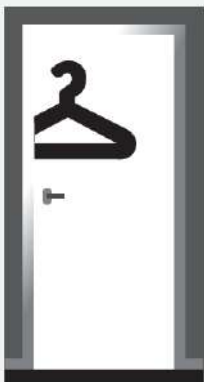

600x600  
Wit-Blanc 4835.F8W  
Grijs-Gris 4835.F8G  
Zwart-Noir 4835.F8Z



300x1195  
Wit-Blanc 4833.F9W  
Grijs-Gris 4833.F9G  
Zwart-Noir 4833.F9Z



600x600  
Wit-Blanc 4835.R4W  
Grijs-Gris 4835.R4G  
Zwart-Noir 4835.R4Z



600x727  
Wit-Blanc 4831.H0W  
Grijs-Gris 4831.H0G  
Zwart-Noir 4831.H0Z



600x1282  
Wit-Blanc 4830.H1W  
Grijs-Gris 4830.H1G  
Zwart-Noir 4830.H1Z

PICTOGRAMMES SUR TRANSFERT

PICTOGRAMMEN OP TRANSFER

# PICTOGRAMMEN OP TRANSFER

Geleverd op drager, wat zorgt voor een snelle en eenvoudige plaatsing.  
Vinyl van een hoge kwaliteit.

# PICTOGRAMMES SUR TRANSFERT

Fournis sur transfert pour une installation rapide et facile.  
Vynile de haute qualité.



	300x1208
Wit-Blanc	4832.H2W
Grijs-Gris	4832.H2G
Zwart-Noir	4832.H2Z



	300x1217
Wit-Blanc	4832.H3W
Grijs-Gris	4832.H3G
Zwart-Noir	4832.H3Z



	600x600
Wit-Blanc	4835.H4W
Grijs-Gris	4835.H4G
Zwart-Noir	4835.H4Z

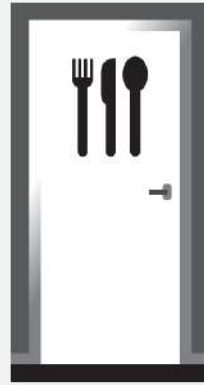

	447x600
Wit-Blanc	4835.H5W
Grijs-Gris	4835.H5G
Zwart-Noir	4835.H5Z



	600x711
Wit-Blanc	4836.H6W
Grijs-Gris	4836.H6G
Zwart-Noir	4836.H6Z



	300x1400
Wit-Blanc	4832.H7W
Grijs-Gris	4832.H7G
Zwart-Noir	4832.H7Z

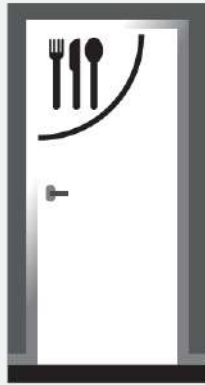

	600x600
Wit-Blanc	4835.H8W
Grijs-Gris	4835.H8G
Zwart-Noir	4835.H8Z

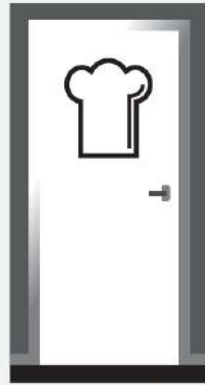

	531x600
Wit-Blanc	4835.H9W
Grijs-Gris	4835.H9G
Zwart-Noir	4835.H9Z

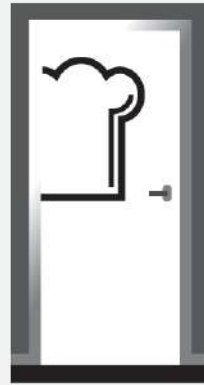

	553x900
Wit-Blanc	4836.K0W
Grijs-Gris	4836.K0G
Zwart-Noir	4836.K0Z



	300x1079
Wit-Blanc	4833.K1W
Grijs-Gris	4833.K1G
Zwart-Noir	4833.K1Z

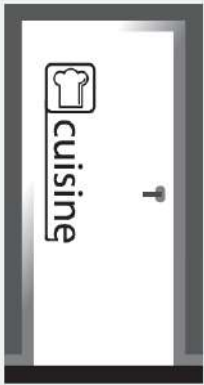

	300x1066
Wit-Blanc	4833.K2W
Grijs-Gris	4833.K2G
Zwart-Noir	4833.K2Z

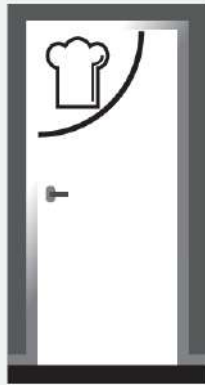

	600x600
Wit-Blanc	4835.K3W
Grijs-Gris	4835.K3G
Zwart-Noir	4835.K3Z

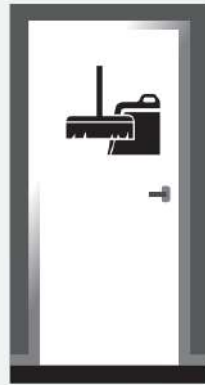

	600x566
Wit-Blanc	4835.K4W
Grijs-Gris	4835.K4G
Zwart-Noir	4835.K4Z



	600x636
Wit-Blanc	4835.K5W
Grijs-Gris	4835.K5G
Zwart-Noir	4835.K5Z



	297x1500
Wit-Blanc	4832.K6W
Grijs-Gris	4832.K6G
Zwart-Noir	4832.K6Z



	300x1500
Wit-Blanc	4832.K7W
Grijs-Gris	4832.K7G
Zwart-Noir	4832.K7Z



	600x600
Wit-Blanc	4835.K8W
Grijs-Gris	4835.K8G
Zwart-Noir	4835.K8Z

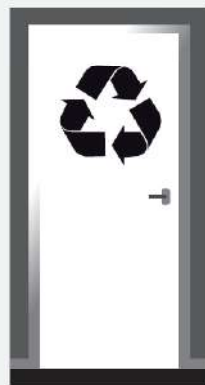

	600x600
Wit-Blanc	4835.K9W
Grijs-Gris	4835.K9G
Zwart-Noir	4835.K9Z

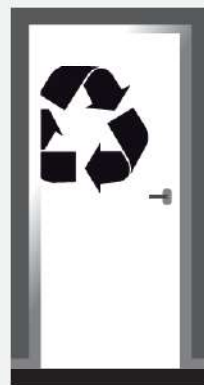

	703x800
Wit-Blanc	483A.L0W
Grijs-Gris	483A.L0G
Zwart-Noir	483A.L0Z



	300x1230
Wit-Blanc	4832.L1W
Grijs-Gris	4832.L1G
Zwart-Noir	4832.L1Z

PICTOGRAMMES SUR TRANSFERT

PICTOGRAMMEN OP TRANSFER

# PICTOGRAMMEN OP TRANSFER

Geleverd op drager, wat zorgt voor een snelle en eenvoudige plaatsing.  
Vinyl van een hoge kwaliteit

# PICTOGRAMMES SUR TRANSFERT

Fournis sur transfert pour une installation rapide et facile.  
Vynile de haute qualité.

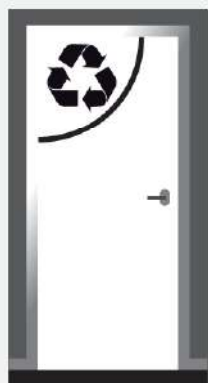

	600x600
Wit-Blanc	4835.L3W
Grijs-Gris	4835.L3G
Zwart-Noir	4835.L3Z

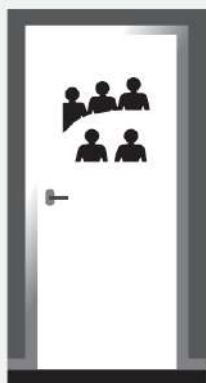

	600x600
Wit-Blanc	4835.L4W
Grijs-Gris	4835.L4G
Zwart-Noir	4835.L4Z

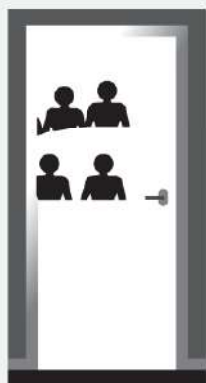

	600x600
Wit-Blanc	4835.L5W
Grijs-Gris	4835.L5G
Zwart-Noir	4835.L5Z



	281x1500
Wit-Blanc	4832.L6W
Grijs-Gris	4832.L6G
Zwart-Noir	4832.L6Z

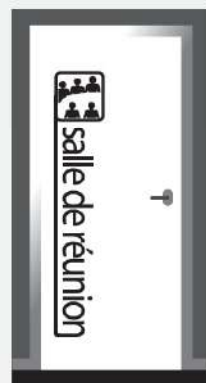

	282x1500
Wit-Blanc	4832.L7W
Grijs-Gris	4832.L7G
Zwart-Noir	4832.L7Z

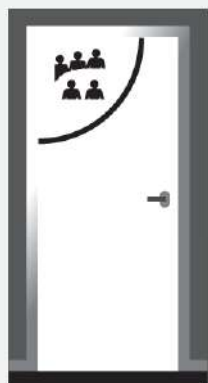

	600x600
Wit-Blanc	4835.L8W
Grijs-Gris	4835.L8G
Zwart-Noir	4835.L8Z



	600x571
Wit-Blanc	4835.L9W
Grijs-Gris	4835.L9G
Zwart-Noir	4835.L9Z



	600x600
Wit-Blanc	4835.M0W
Grijs-Gris	4835.M0G
Zwart-Noir	4835.M0Z



	269x1000
Wit-Blanc	4833.M1W
Grijs-Gris	4833.M1G
Zwart-Noir	4833.M1Z



	269x1000
Wit-Blanc	4833.M2W
Grijs-Gris	4833.M2G
Zwart-Noir	4833.M2Z

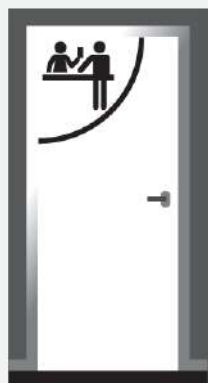

	600x600
Wit-Blanc	4835.M3W
Grijs-Gris	4835.M3G
Zwart-Noir	4835.M3Z



	416x600
Wit-Blanc	4835.M4W
Grijs-Gris	4835.M4G
Zwart-Noir	4835.M4Z



	470x900
Wit-Blanc	4836.M5W
Grijs-Gris	4836.M5G
Zwart-Noir	4836.M5Z



	300x1360
Wit-Blanc	4830.M6W
Grijs-Gris	4830.M6G
Zwart-Noir	4830.M6Z



	300x1375
Wit-Blanc	4832.M7W
Grijs-Gris	4832.M7G
Zwart-Noir	4832.M7Z

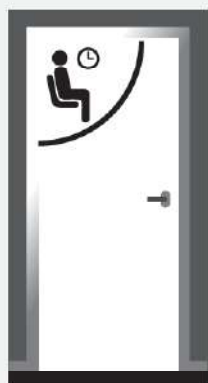

	600x600
Wit-Blanc	4835.M8W
Grijs-Gris	4835.M8G
Zwart-Noir	4835.M8Z



	582x600
Wit-Blanc	4835.M9W
Grijs-Gris	4835.M9G
Zwart-Noir	4835.M9Z



	464x600
Wit-Blanc	4835.N0W
Grijs-Gris	4835.N0G
Zwart-Noir	4835.N0Z

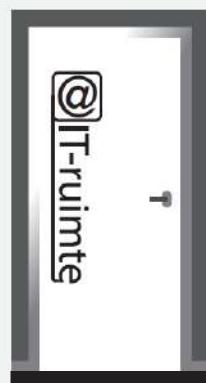

	300x1261
Wit-Blanc	4836.N1W
Grijs-Gris	4836.N1G
Zwart-Noir	4836.N1Z



	300x1038
Wit-Blanc	4832.N2W
Grijs-Gris	4832.N2G
Zwart-Noir	4832.N2Z

PICTOGRAMMES SUR TRANSFERT

PICTOGRAMMEN OP TRANSFER

# PICTOGRAMMEN OP TRANSFER

Geleverd op drager, wat zorgt voor een snelle en eenvoudige plaatsing.  
Vinyl van een hoge kwaliteit.

# PICTOGRAMMES SUR TRANSFERT

Fournis sur transfert pour une installation rapide et facile.  
Vinyle de haute qualité.

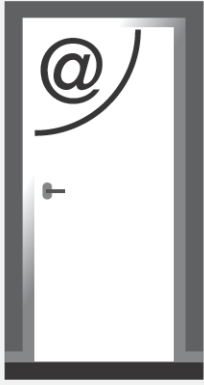

600x600

Wit-Blanc 4835.N3W  
Grijs-Gris 4835.N3G  
Zwart-Noir 4835.N3Z

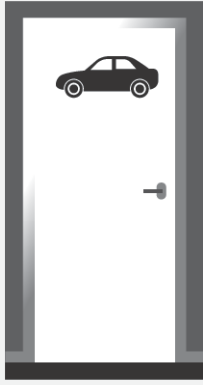

600x240

Wit-Blanc 483B.N4W  
Grijs-Gris 483B.N4G  
Zwart-Noir 483B.N4Z

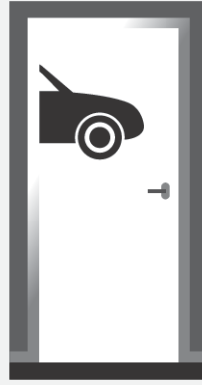

600x483

Wit-Blanc 4835.N5W  
Grijs-Gris 4835.N5G  
Zwart-Noir 4835.N5Z

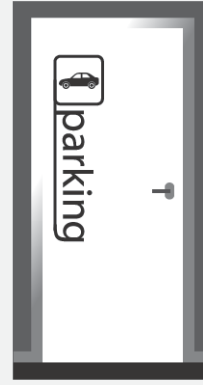

300x1117

Wit-Blanc 4833.N6W  
Grijs-Gris 4833.N6G  
Zwart-Noir 4833.N6Z

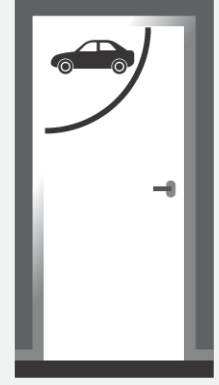

600x600

Wit-Blanc 4835.N7W  
Grijs-Gris 4835.N7G  
Zwart-Noir 4835.N7Z

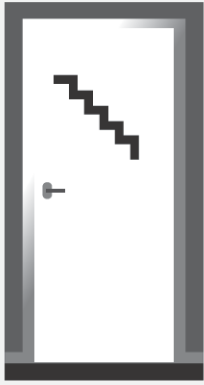

600x600

Wit-Blanc 4835.N8W  
Grijs-Gris 4835.N8G  
Zwart-Noir 4835.N8Z

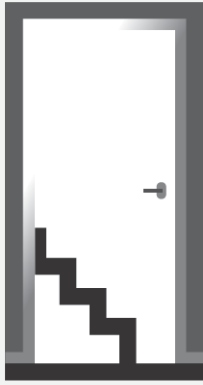

600x738

Wit-Blanc 4833.N9W  
Grijs-Gris 4833.N9G  
Zwart-Noir 4833.N9Z

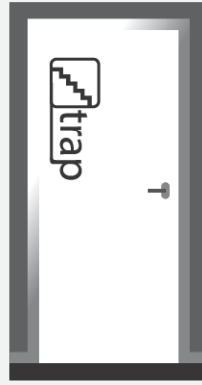

300x733

Wit-Blanc 483B.P0W  
Grijs-Gris 483B.P0G  
Zwart-Noir 483B.P0Z

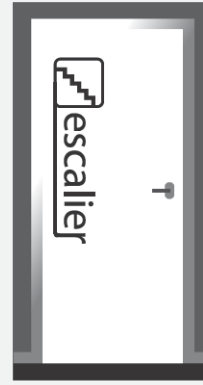

300x1115

Wit-Blanc 4833.R2W  
Grijs-Gris 4833.R2G  
Zwart-Noir 4833.R2Z

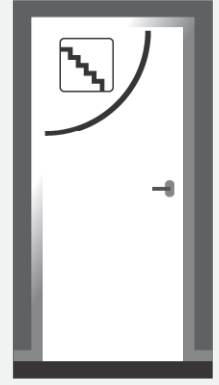

600x600

Wit-Blanc 4835.P2W  
Grijs-Gris 4835.P2G  
Zwart-Noir 4835.P2Z



600x627

Wit-Blanc 4835.P3W  
Grijs-Gris 4835.P3G  
Zwart-Noir 4835.P3Z



556x900

Wit-Blanc 4831.P4W  
Grijs-Gris 4831.P4G  
Zwart-Noir 4831.P4Z



556x900

Wit-Blanc 4831.P5W  
Grijs-Gris 4831.P5G  
Zwart-Noir 4831.P5Z

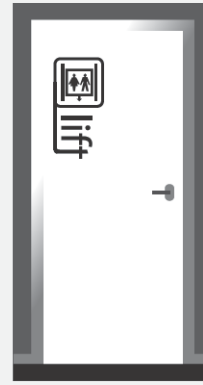

300x605

Wit-Blanc 483B.P6W  
Grijs-Gris 483B.P6G  
Zwart-Noir 483B.P6Z

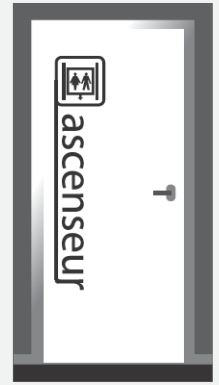

300x1393

Wit-Blanc 4832.P7W  
Grijs-Gris 4832.P7G  
Zwart-Noir 4832.P7Z

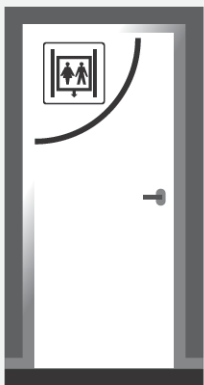

600x600

Wit-Blanc 4835.P8W  
Grijs-Gris 4835.P8G  
Zwart-Noir 4835.P8Z



Andere pictogrammen en/of teksten mogelijk op aanvraag.

Autres pictogrammes et/ou textes possibles sur demande.

PICTOGRAMMES SUR TRANSFERT

PICTOGRAMMEN OP TRANSFER













































# INFOPLAATJES

# PLAQUETTES D'INFORMATION

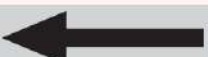
ALULOOK met dubbelzijdige kleefstrook

LOOK ALU avec adhésif double face







































PLAQUETTES D'INFORMATION

<b>heren</b>  PVC 165x45   4921.010	<b>toiletten</b>  PVC 165x45   4921.014	<b>garderobe</b>  PVC 165x45   4921.019	<b>kleedkamer</b>  PVC 165x45   4921.067	 	
<b>dames</b>  PVC 165x45   4921.011	<b>toiletten</b>  PVC 165x45   4921.015	<b>vestiaire</b>  PVC 165x45   4921.034	<b>kleedkamer</b>  PVC 165x45   4921.066		45x165   4921.012
<b>douche</b>  PVC 165x45   4921.053	<b>receptie</b>  PVC 165x45   4921.055	<b>onthaal</b>  PVC 165x45   4921.044	<b>vrije ingang</b>  PVC 165x45   4921.075	<b>t r e k k e n</b> 45x165   4921.071	<b>d u w e n</b> 45x165   4921.070
<b>bellen</b>  PVC 165x45   4921.073	<b>deur sluiten aub</b> PVC 165x45   4921.042	<b>trekken</b> PVC 165x45   4921.021	<b>duwen</b> PVC 165x45   4921.020		
<b>parking</b>  PVC 165x45   4921.054	<b>lift</b>  PVC 165x45   4921.046	<b>secretariaat</b> PVC 165x45   4921.040	<b>wachtkamer</b>  PVC 165x45   4921.074	<b>info</b>  PVC 165x45   4921.050	
<b>roken toegestaan</b>  PVC 165x45   4921.018	<b>telefoon</b>  PVC 165x45   4921.017	<b>restaurant</b>  PVC 165x45   4921.016	<b>eetzaal</b>  PVC 165x45   4921.065	<b>kantine</b>  PVC 165x45   4921.078	
<b>kantoor</b>  PVC 165x45   4921.072	<b>bureel</b>  PVC 165x45   4921.048	<b>kassa</b>  PVC 165x45   4921.051	<b>archieff</b>  PVC 165x45   4921.062	<b>server</b>  PVC 165x45   4921.064	
<b>berging</b>  PVC 165x45   4921.063	<b>container lokaal</b>  PVC 165x45   4921.060	<b>magazijn</b>  PVC 165x45   4921.076	<b>werkplaats</b> PVC 165x45   4921.077	<b>kelder</b> PVC 165x45   4921.058	
<b>eerste hulp</b>  PVC 165x45   4921.007	<b>ingang</b> PVC 165x45   4921.009	<b>uitgang</b> PVC 165x45   4921.008	<b>geen toegang</b>  PVC 165x45   4921.003	<b>privaat</b>  PVC 165x45   4921.030	
<b>honden verboden</b>  PVC 165x45   4921.002	<b>draagbare telefoons verboden</b>  PVC 165x45   4921.004	<b>niet rokers ruimte</b>  PVC 165x45   4921.005	<b>roken verboden</b>  PVC 165x45   4921.001	 PVC 165x45   4921.006	
 PVC 45x45   4920.001	 PVC ophanghaakje voor pictogrammen, zelfklevend Crochet suspensiu en pvc pour pictogrammes, adhésif B351	<div style="border: 1px solid black; padding: 5px;"> <div style="text-align: right; font-weight: bold; font-size: small;">PIKT-O-NORM<sup>®</sup> ALU LOOK</div> <div style="display: flex; justify-content: space-between; align-items: center;"> <div style="text-align: center;">  </div> <div style="text-align: center;"> <b>verzorging</b>  </div> <div style="text-align: center;"> <b>local eau</b>  </div> </div> <div style="text-align: center; font-size: x-small; margin-top: 5px;">                     Uw gepersonaliseerde infoplaatjes - Vos plaquettes d'information personnalisées                 </div> <div style="text-align: right; font-size: x-small; margin-top: 5px;">                     PVC                      4921.MT                 </div> </div>			

INFOPLAATJES

ALULOOK met dubbelzijdige kleefstrook

LOOK ALU avec adhésif double face

<b>messieurs</b>  PVC 165x45   4921.031	<b>toilettes</b>  PVC 165x45   4921.033	<b>garderobe</b>  PVC 165x45   4921.019	<b>vestiaire</b>  PVC 165x45   4921.089	 45x165   4921.012	 45x165   4921.013
<b>dames</b>  PVC 165x45   4921.011	<b>toilettes</b>  PVC 165x45   4921.032	<b>vestiaire</b>  PVC 165x45   4921.034	<b>vestiaire</b>  PVC 165x45   4921.088		
<b>douche</b>  PVC 165x45   4921.053	<b>réception</b>  PVC 165x45   4921.045	<b>accueil</b>  PVC 165x45   4921.079	<b>entrée libre</b>  PVC 165x45   4921.082	<b>tirer</b> 45x165   4921.069	<b>pousser</b> 45x165   4921.068
<b>sonnez</b>  PVC 165x45   4921.080	<b>fermez la porte svp</b> PVC 165x45   4921.043	<b>tirer</b> PVC 165x45   4921.039	<b>pousser</b> PVC 165x45   4921.038		
<b>parking</b>  PVC 165x45   4921.054	<b>ascenseur</b>  PVC 165x45   4921.047	<b>secrétariat</b> PVC 165x45   4921.041	<b>salle d'attente</b>  PVC 165x45   4921.081	<b>info</b>  PVC 165x45   4921.050	
<b>permission de fumer</b>  PVC 165x45   4921.035	<b>téléphone</b>  PVC 165x45   4921.029	<b>restaurant</b>  PVC 165x45   4921.016	<b>cantine</b>  PVC 165x45   4921.087	<b>bureau</b>  PVC 165x45   4921.049	
<b>caisse</b>  PVC 165x45   4921.052	<b>archives</b>  PVC 165x45   4921.085	<b>server</b>  PVC 165x45   4921.064	<b>débarras</b>  PVC 165x45   4921.086	<b>poubelles</b>  PVC 165x45   4921.061	
<b>magasin</b>  PVC 165x45   4921.083	<b>atelier</b> PVC 165x45   4921.084	<b>caves</b> PVC 165x45   4921.059	<b>premiers secours</b>  PVC 165x45   4921.025	<b>entrée</b> PVC 165x45   4921.023	
<b>sortie</b> PVC 165x45   4921.024	<b>entrée interdite</b>  PVC 165x45   4921.027	<b>privé</b>  PVC 165x45   4921.022	<b>interdit pour les chiens</b>  PVC 165x45   4921.036	<b>interdit aux téléphones portables</b>  PVC 165x45   4921.037	
<b>espace non-fumeurs</b>  PVC 165x45   4921.026	<b>défense de fumer</b>  PVC 165x45   4921.028	<b>pull</b> PVC 165x45   4921.057	<b>push</b> PVC 165x45   4921.056	 PVC 165x45   4921.006	



Pvc ophanghaakje voor pictogrammen, zelfklevend  
Crochet suspendu en pvc pour pictogrammes, adhésif

PVC  
45x45 | 4920.001

B351



Alle picto's kunnen, op aanvraag, met BARCODE worden geleverd, afzonderlijk (Ref.: BARCO1) of gekleefd (Ref.: BARCO2).

Tous les pictos peuvent, sur demande, être livrés à CODE - BARRES séparément (Réf.: BARCO1) ou collés (Réf.: BARCO2).

## OPHANGPICTOGRAMMEN



PP  
120x120 5722.01



PP  
120x120 5722.02



PP  
120x120 5722.03



PP  
120x120 5722.04

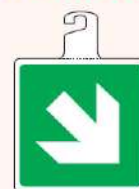

PP  
120x120 5722.05



PP  
120x120 5722.06



PP  
120x120 5722.07



PP  
120x120 5722.83



PP  
120x120 5722.08



PP  
120x120 5722.84



PP  
120x120 5722.09



PP  
120x120 5722.85



PP  
120x120 5722.11



PP  
120x120 5722.87



PP  
120x120 5722.86



PP  
120x120 5722.10

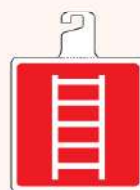

PP  
120x120 5722.12



PP  
120x120 5722.88



PP  
120x120 5722.15



PP  
120x120 5722.13



PP  
120x120 5722.14



PP  
120x120 5722.29



PP  
120x120 5722.89



PP  
120x120 5722.30

**Ophangpictogrammen,**  
vervaardigd uit een flexibele PP van 0,8mm.  
Voorzien van een dubbelzijdige, hoogwaardige  
kleeftaag.  
De haak is eenvoudig te verwijderen.  
Alle pictogrammen zijn voorzien van een product-  
en barcode.

**Pictogrammes à crochet,** fabriqués en polyprop  
flexible de 0,8mm. Pourvus d'un adhésif  
double face.  
Le crochet est facilement enlevable. Tous les  
pictogrammes sont pourvus d'un code produit  
et d'un code - barres.

# OPHANGPICTOGRAMMEN

# PICTOGRAMMES A CROCHET



PP  
120mm 5722.31



PP  
120mm 5722.32



PP  
120mm 5722.38



PP  
120mm 5722.35



PP  
120mm 5722.37



PP  
120mm 5722.34



PP  
120mm 5722.33



PP  
120mm 5722.39



PP  
120mm 5722.41



PP  
120mm 5722.40



PP  
120mm 5722.36



PP  
120mm 5722.45



PP  
120mm 5722.43



PP  
120mm 5722.44



PP  
120mm 5722.42



PP  
120mm 5722.90



PP  
120mm 5722.21



PP  
120mm 5722.91



PP  
120mm 5722.22



PP  
120mm 5722.92



PP  
120mm 5722.23



PP  
120mm 5722.93



PP  
120mm 5722.24



PP  
120mm 5722.25



PP  
120mm 5722.26



PP  
120mm 5722.27





PP  
120mm 5722.28

## OPHANGPICTOGRAMMEN



## PICTOGRAMMES A CROCHET

				
PP 120mm 5722.46	PP 5722.48	PP 5722.47	PP 5722.51	PP 5722.50

				
PP 120mm 5722.52	PP 5722.53	PP 5722.56	PP 5722.57	PP 5722.49

	
PP 120mm 5722.54	PP 5722.55

  
 De gewenste hangpictogram niet gevonden in ons gamma? Prijs op aanvraag.  
 Vous ne trouvez pas le pictogramme à crochet souhaité? Prix sur demande.

				
PP 120x120mm 5722.67	PP 5722.68	PP 5722.71	PP 5722.70	PP 5722.69

				
PP 120x120mm 5722.66	PP 5722.79	PP 5722.63	PP 5722.64	PP 5722.65

				
PP 120x120mm 5722.80	PP 5722.62	PP 5722.72	PP 5722.73	PP 5722.82

## OPHANGPICTOGRAMMEN

## PICTOGRAMMES A CROCHET



PP  
120x120 | 5722.75



PP  
120x120 | 5722.74



PP  
120x120 | 5722.77



PP  
120x120 | 5722.76

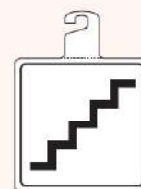

PP  
120x120 | 5722.59



PP  
120x120 | 5722.60



PP  
120x120 | 5722.61

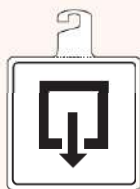

PP  
120x120 | 5722.58



PP  
120x120 | 5722.78

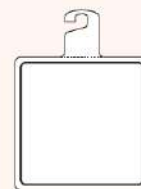

PP  
120x120 | 5722.81



PP  
120x120 | 5722.16



PP  
120x120 | 5722.17



PP  
120x120 | 5722.18



PP  
120x120 | 5722.19



PP  
120x120 | 5722.20

Ideaal voor uw retailverkoop

*Idéal pour votre vente au détail*



Onze ophangpictogrammen lenen zich perfect tot gebruik in de retail.

Samen met een greep uit de rest van ons gamma betekenen ze een grote meerwaarde voor uw winkelassortiment.

Wij assisteren en begeleiden u graag bij uw keuze.

Nos pictogrammes à crochet sont idéals dans la vente au détail.

Combiné avec d'autres produits de notre gamme ils apportent une plus-value pour l'assortiment dans votre magasin.

Nous vous guidons avec plaisir dans votre choix.

TEKSTEN

TEXTES

**VERBODEN TOEGANG**

	PP	VIN.	Signicolor 1,5mm
400x250	1723.12	1733.12	1713.12

**VERBODEN TOEGANG VOOR ONBEVOEGDEN**

	PP	VIN.
400x250	1723.05	1733.05

**VERBODEN INGANG**

	PP	VIN.
400x250	1723.32	1733.32

**VERBODEN DOORGANG**

	PP	VIN.
400x250	1723.D9	1733.D9

**DOORGANG VRIJLATEN**

	PP	VIN.
400x250	1723.34	1733.34

**INRIT VRIJHOUDEN**

	PP	VIN.
400x250	1723.H6	1733.H6

**OPGELET UITGANG VRACHTWAGENS**

	PP
400x250	1723.H5

**STRENG VERBODEN TOEGANG**

	PP	VIN.
400x250	1723.A4	1733.A4

**VERBODEN TOEGANG PRIVAAT TERREIN**

	PP	VIN.
400x250	1723.A5	1733.A5

**TOEGANG VERBODEN VOOR VOERTUIGEN OP L.P.G.**

	PP	VIN.
400x250	1723.46	1733.46

**VERBODEN TOEGANG OPSLAG MESTSTOFFEN**

	PP	VIN.
400x250	1723.C1	1733.C1

**VERBODEN DOORGANG GEVAARLIJKE WERKEN AAN DE GANG**

	PP	VIN.
400x250	1723.44	1733.44

**VERBODEN OP DE WERF TE KOMEN**

	PP	VIN.	FOREX 3mm
400x250 600x400 900x600	1723.A7	1733.A7	1755.A7 1756.A7

**BETREDEN OP EIGEN RISICO**

	PP	VIN.
400x250	1723.B3	1733.B3

**INGANG**

	PP
400x250	1723.C9

**MOTOR AFZETTEN**

	PP	VIN.
400x250	1723.D2	1733.D2

**MOTOR AFZETTEN  
ROKEN EN OPEN VUUR VERBODEN**

	PP	VIN.
400x250	1723.F5	1733.F5

**PARKEREN VERBODEN**

	PP	VIN.
400x250	1723.C8	1733.C8

**PARKEREN OP EIGEN RISICO**

	PP	VIN.
400x250 400x300	1722.B5 1723.B5	1732.B5 1733.B5

**PRIVAAT**

	PP	VIN.
400x250	1723.27	1733.27

**PRIVE**

	PP	VIN.
400x250	1723.99	1733.99

**PRIVATE WEG**

	PP	Signi- color 1,5mm
400x250	1723.28	1713.28

**PRIVAAT PARKING**

	PP	VIN.
400x250	1723.15	1733.15

**PRIVE PARKING**

	PP	VIN.
400x250	1723.81	1733.81

**PRIVAAT TERREIN**

	PP	VIN.
400x250	1723.14	1733.14

**PRIVE TERREIN**

	PP	VIN.
400x250	1723.80	1733.80

**EIGEN TERREIN**

	PP
400x250	1723.F6

**NOODUITGANG VRIJHOUDEN**

	PP	VIN.
400x250	1723.C4	1733.C4

**BRAND-DEUR**

	PP	VIN.
175x115	1721.55	1731.55

**BRANDDEUR VRIJHOUDEN AUB**

	PP	VIN.
400x250	1723.96	1733.96

**BRANDDEUR DICHTHOUDEN AUB**

	PP	VIN.
100x70 400x250	1721.97 1723.97	1731.97 1733.97

**OP LAST VAN DE BRANDWEER DEUREN GESLOTEN HOUDEN**

	VIN.
150x100	1731.J8



# TEKSTEN

# TEXTES

**DEUR  
SLUITEN**

	PP	VIN.
190x65	1721.35	1731.35
400x250	1723.35	1733.35

**DEUR MOET  
GESLOTEN  
BLIJVEN**

	PP	VIN.
400x250	1723.95	1733.95

**DEUR DICTH  
A.U.B.**

	PP
400x250	1723.E2

**DEUR SLUITEN A.U.B.**

	VIN.
200x80	1731.K0

**GEVAAR  
DEUREN IN  
ONDERHOUD**

	PP
400x300	1723.D3

**POORT  
SLUITEN**

	VIN.
400x250	1733.K4

**VERBODEN  
FIETSEN TE  
PLAATSEN**

	PP
400x250	1723.45

**WIJ ZIJN NIET  
VERANTWOORDELIJK  
VOOR GEBEURLIJKE  
ONGEVALLLEN**

	PP
400x300	1723.V1

**DE DIRECTIE IS NIET  
AANSPRAKELIJK  
VOOR DIEFSTAL  
OF BESCHADIGING**

	PP	VIN.
250x90	1721.H8	1731.H8

**OPEN**

	PP	VIN.
250x80	1721.51	1731.51

**GESLOTEN**

	PP	VIN.
250x80	1721.52	1731.52

**VERBODEN ONDER DE  
HANGENDE LASTEN  
DOOR TE GAAN**

	PP	VIN.
400x250	1723.01	1733.01

**VERBODEN  
ONDER DE LAST  
TE KOMEN**

	PP	VIN.
200x100	1721.03A	1731.03A
250x150		1732.03A
400x250	1723.03	1733.03

**VERBODEN ONDER  
LAST- EN ZWENK-  
BEREIK VAN DE  
KRAAN TE KOMEN**

	PP	VIN.
400x250	1723.02	1733.02

**VERBODEN IN DE  
DRAAICIRKEL  
TE KOMEN**

	PP	VIN.
400x250	1723.04	1733.04

**OPGEPAST  
AUTOMATISCH  
OPSTARTENDE  
MACHINE**

	PP	VIN.
400x250	1723.98	1733.98

**OPGEPAST  
MACHINE START  
AUTOMATISCH**

	PP	VIN.
400x250	1723.A6	1733.A6

**NIET IN WERKENDE  
MACHINE GRIJPEN**

	PP	VIN.
150x70		1731.L1
250x100	1721.53	1731.53
400x250	1723.53	1733.53

**OPGEPAST  
AUTOMATISCHE  
TRANSFERT**

	PP	VIN.
400x250	1723.33	1733.33

**VERBODEN  
IN TE  
SCHAKELN**

	PP
400x250	1723.K6

**VERBODEN  
OP TE  
STARTEN**

	PP	VIN.
300x120	1723.50	1733.50

**HEFVERMOGEN  
KG**

	PP	VIN.
250x150	1722.11	1732.11
400x250	1723.11	1733.11

**MAXIMUM  
HEFVERMOGEN  
KG**

	PP	VIN.
250x150		1732.16
400x250	1723.16	1733.16

**OPENEN VAN  
AFSLUITERS VAN  
GASFLESSEN  
VERBODEN**

	PP
400x300	1723.M6

**TJJDENS LADEN, LOSSEN EN ONTGASSEN  
NIET OPENEN  
ZONDER TOESTEMMING VAN DE SCHIPPER  
ONMIDDELLIJK SLUITEN**

	VIN.
125x70	1730.T2

**VERBODEN  
VOOR  
PERSONENVERVOER**

	PP	VIN.
400x250	1723.C2	1733.C2

**OPSLAG  
MESTSTOFFEN**

	PP	VIN.
400x250	1723.B4	1733.B4

**OPSLAG  
BRANDSTOFFEN**

	PP	VIN.
400x250	1723.C7	1733.C7

**GEWAS  
BESCHERMINGS-  
MIDDELEN  
OPSLAG**

	PP	VIN.
400x250	1723.D4	1733.D4

**STOOKLOKAAL**

	PP
400x250	1723.E1

**WERKPLAATS**

	PP
400x250	1723.D8

**VEILIGHEIDS-  
MATERIALEN**

	PP	VIN.
300x250	1723.30	1733.30



TEKSTEN

TEXTES

**TECHNISCHE  
RUIMTE**

	VIN.
250x80	1731.K2

**GELIEVE DEZE RUIMTE NET  
EN ORDELIJK TE HOUDEN**

	VIN.
400x100	1732.K7

**LIFT-  
MACHINEKAMER**

	VIN.
250x80	1731.K3

**LIFTMACHINEKAMER  
VERBODEN TOEGANG  
VOOR  
ONBEVOEGDEN**

	VIN.
150x100	1731.J7

**LIFT NIET GEBRUIKEN BIJ BRAND**

	VIN.
200x50	1730.J5

**VERBODEN LIFT  
TE GEBRUIKEN  
IN GEVAL  
VAN BRAND**

	PP	VIN.
80x50	1720.56	1730.56
100x70	1721.56	1731.56

**VERBODEN LIFT  
TE GEBRUIKEN  
BIJ BRAND**

	PP	VIN.
100x70	1721.57	1731.57
200x150	1722.57	1732.57

**VERBODEN  
GEBRUIK  
BIJ BRAND**

	VIN.
120x60	1731.54

**UITSLUITEND  
TE GEBRUIKEN  
BIJ BRAND**

	VIN.
400x250	1733.K1

**ALLEEN VOOR  
GEBRUIK BIJ  
BRAND**

	VIN.
100x50	1730.H3
200x100	1731.H3

**ALLEEN  
GEBRUIKEN  
BIJ BRAND**

	PP
100x100	1720.J6

**ENKEL GEBRUIKEN  
BIJ BRAND**

	PP	VIN.
120x60	1721.F7	1731.F7

**ALLEEN VOOR GEBRUIK  
BIJ BRAND  
HASPEL IS VERZEGELD I.V.M.  
LEGIONELLA PREVENTIE**

	PP	VIN.
100x50	1720.B6	1730.B6
100x60	172A.B6	173A.B6
200x100	1721.B6	1731.B6

**BRAND-  
ALARM**

	PP	VIN.
400x250	1723.36	1733.36

**ROKEN EN OPEN  
VUUR  
VERBODEN**

	PP	VIN.	SIGNICOLOR 1,5mm
250x150		1731.24	
400x250	1723.24	1733.24	1713.24

**VERBODEN  
TE ROKEN**

	PP	VIN.
400x250	1723.25	1733.25

**VERBODEN  
te ROKEN, te LASSEN  
te BRANDEN of VUUR  
te MAKEN**

	PP	VIN.
400x250	1723.13	1733.13

**VERBODEN  
TE STORTEN**

	PP	VIN.
400x250	1723.26	1733.26

**VERBODEN  
TE STORTEN  
BIJ POLITIEBEVEL**

	PP	VIN.
400x250	1723.A3	1733.A3

**VERBODEN  
TE WATEREN**

	PP	VIN.
400x250	1723.37	1733.37

**TE KOOP**

	PP	VIN.
400x250	1723.29	1733.29

**TE HUUR**

	PP	VIN.
400x250	1723.D5	1733.D5

**GEVAARLIJKE  
HOND**

	PP	VIN.
250x170	1722.49	1732.49
400x250	1723.49	1733.49

**OPGEPAST  
GEVAARLIJKE  
HOND**

	PP	VIN.
400x250	1723.17	1733.17

**BHV**

	PP	VIN.
200x150	1721.B8	1731.B8

**legionella - preventie**



• brandstanghaspel afhalen  
gebruiken bij brand  
• controleer mandjes  
de verpakking van de  
hoofdshakker



**STRENG VERBODEN  
AAN TE PLAKKEN**

	PP	VIN.
300x100	1722.M1	1732.M1

**HIER UW  
EIGEN TEKST  
ICI VOTRE  
PROPRE TEXTE**

	PP	VIN.
200x100	1721.MT	1731.MT
400x250	1722.MT	1732.MT
400x300	1723.MT	1733.MT

**HIER UW  
EIGEN TEKST  
ICI VOTRE  
PROPRE TEXTE**

	SIGNICOLOR 1,5mm
250x200	1712.MT
300x150	1711.MT
400x250	1713.MT

	PP	VIN.
200x100	1721.00W	
400x250	1722.00	1732.00
400x300	1723.00	1733.00

# TEKSTEN

# TEXTES

**TOEGANG VERBODEN  
VOOR ONBEVOEGDEN**  
ACCES INTERDIT  
AUX PERSONNES NON  
AUTORISEES

**VERBODEN OP DE  
WERKEN TE KOMEN**  
INTERDICTION DE  
CIRCULER SUR  
LES TRAVAUX

**DEUR GESLOTEN HOUDEN**  
FERMEZ LA PORTE

**VERBODEN LIFT TE  
GEBRUIKEN BIJ BRAND**  
INTERDICTION D'EMPLOYER  
L'ASCENSEUR EN CAS D'INCENDIE

**INTERDICTION  
D'UTILISER L'ASCENSEUR  
EN CAS D'INCENDIE**  
VERBODEN  
DE LIFT TE GEBRUIKEN  
BIJ BRAND

	PP	VIN.		PP	VIN.		PP	VIN.		PP	VIN.		VIN.
400x300	1723.39	1733.39	400x250	1723.79	1733.79	400x250	1723.78	1733.78	240x150	1722.58	1732.58	200x100	1731.H7

**ROKEN VERBODEN**  
DEFENSE DE FUMER

**BRANDEUR  
DICHTHOUDEN AUB**  
PORTE COUPE FEU  
MAINTENIR FERMEE

**ENTREE  
INTERDITE**

**ACCES INTERDIT  
AUX PERSONNES  
NON AUTORISEES**

**DEFENSE D'ENTRER  
AUX PERSONNES  
NON AUTORISEES**

	PP	VIN.		VIN.		PP	VIN.		PP	VIN.		PP	VIN.
400x250	1723.48	1733.48	100x60	1731.55	400x250	1723.07	1733.07	400x250	1723.07	400x250	1723.07	400x250	1723.38   1733.38

**DEFENSE  
D'ENTRER**

**PASSAGE  
INTERDIT**

**PROPRIETE PRIVEE**  
DEFENSE  
DE PENETRER

**DEFENDU  
AUX  
PERSONNES**

**ATTENTION  
SORTIE  
DE CAMIONS**

	PP			PP	VIN.		PP			PP	VIN.		PP
400x250	1723.61		400x250	1723.60	1733.60	400x250	1723.64		400x250	1723.08	1733.08	400x250	1723.71

**DEFENSE  
DE CIRCULER  
SUR LES TRAVAUX**

**ATTENTION TRAVAUX**  
DANGER

**ENTREZ  
LENTEMENT**

**SORTEZ  
LENTEMENT**

	PP	VIN.	FOREX 3mm		PP			PP		PP	VIN.		PP	VIN.
400x250 600x400	1723.40	1733.40	1755.40		400x250	1723.70		400x250	1723.62	400x250	1723.63	1733.63		

**VOIE  
SANS ISSUE**

**PRIVÉ**

**PARKING PRIVÉ**

**PROPRIÉTÉ  
PRIVÉE**

**SORTIE DE SECOURS  
LAISSEZ LIBRE  
S.V.P.**

	PP	VIN.		PP	VIN.		PP	VIN.		PP	VIN.		VIN.
400x250	1723.77	1733.77	400x250	1723.82	1733.82	400x250	1723.19	1733.19	400x250	1723.20	1733.20	400x250	1733.F2

**LAISSEZ  
LA PORTE COUPE-FEU**  
FERMEE S.V.P.

**FERMEZ  
LA PORTE**

**LA PORTE  
DOIT RESTER  
FERMEE**

**OUVERT**

**FERMEE**

	VIN.			PP	VIN.		VIN.		PP			PP	
100x70 400x250	1731.F3 1733.F3		400x250	1723.41	1733.41	400x250	1733.K5		250x80	1721.68		250x80	1721.69

**DEFENSE DE  
CIRCULER  
EN DESSOUS  
DES CHARGES**

**DEFENSE DE  
STATIONNER  
SOUS LA CHARGE**

	PP	VIN.		PP	VIN.
400x250	1723.09	1733.09	400x250	1723.10	1733.10



**BRENG UW BOODSCHAP OP EEN STIJLVOLLE MANIER  
PRESENTÉZ VOTRE MESSAGE EN STYLE**

PAG. 214 - 215

# TEKSTEN

# TEXTES

TEXTES

**ATTENTION  
DEMARRAGE  
AUTOMATIQUE**

**NE PAS PENETRER  
DANS LA MACHINE  
EN MARCHE**

**CHARGE  
MAX..... KG**

**DECHARGE  
INTERDITE**

**MATERIEL  
DE  
SECURITE**

PP	VIN.	PP	VIN.	PP	VIN.	PP	VIN.	PP	VIN.					
400x250	1723.75	1733.75	400x250	1723.76	1733.76	400x250	1723.18	1733.18	400x250	1723.69	1733.69	300x250	1723.43	1733.43

**PORT OBLIGATOIRE  
DES EQUIPEMENTS  
DE SECURITE**

**NE PAS UTILISER  
SUR FLAMME GAZ**

**EN CAS D'INCENDIE  
NE PAS UTILISER  
L'ASCENSEUR**

**UTILISATION UNIQUEMENT  
EN CAS D'INCENDIE  
DÉVIDOIR SCELLÉ POUR  
PRÉVENTION LEGIONELLA**

**AVERTISSEUR  
D'INCENDIE**

PP	VIN.	PP	VIN.	PP	VIN.	VIN.	PP	VIN.			
400x300	1723.M0	400x250	1723.72	100x70	1721.E8	1731.E8	100x50	1730.V7	400x250	1723.42	1733.42
				240x150	1722.E8						

**DEFENSE  
DE  
FUMER**

**DEFENSE  
DE  
FUMER  
AU DELA  
DE CETTE LIMITE**

**FLAMME NUE INTERDITE  
ET DEFENSE DE FUMER**

**MAINTENONS  
NOS TOILETTES  
PROPRES**

**A VENDRE**

PP	VIN.	PP	VIN.	PP	VIN.	PP	VIN.	PP	VIN.				
400x250	1723.73	1733.73	400x250	1723.74	1733.74	400x250	1723.B2	1733.B2	400x250	1723.K8	400x250	1723.L0	1733.L0

**A LOUER**

**ATTENTION  
CHIEN  
DANGEREUX**

**CHASSE  
PRIVEE**



**DEUR GESLOTEN HOUDEN  
KEEP DOOR CLOSED**

PP	VIN.	PP	VIN.	PP	VIN.	VIN.	PP	VIN.							
400x250	1723.G6	1733.G6	400x250	1723.22	1733.22	400x250	1723.21	1733.21	300x100	1732.P8	150x100	1731.31	400x250	1723.31	1733.31

**JUST FOR USE  
IN CASE OF FIRE  
HOSE REEL IS SECURED  
TO PREVENT LEGIONELLA**

**TOEGANG VERBODEN  
VOOR ONBEVOEGDEN  
ACCES INTERDIT AUX  
PERSONNES NON AUTORISEES  
RESTRICTED AREA  
AUTHORIZED EMPLOYEES ONLY**

**VERBODEN TOEGANG  
ENTREE INTERDITE  
NO ENTRANCE  
EINGANG VERBODEN**

**VERBODEN TE ROKEN  
DEFENSE DE FUMER  
NO SMOKING  
NIGHT RAUCHEN**

PP	VIN.	PP	VIN.	PP	VIN.	PP	VIN.				
100x60	1721.C7	1731.C7	400x300	1723.93	1733.93	400x300	1723.83	1733.83	400x300	1723.47	1733.47



PP	VIN.	PP	VIN.	PP	VIN.			
200x100	1721.M8	1731.M8	200x100	1721.G1	1731.G1	200x100	1721.MTZ	1731.MTZ



TEKSTEN

**Verboden toegang voor onbevoegden**  
Art. 461 Wetb.v. Strafrecht

**VERBODEN OP DE WERKEN TE KOMEN**

**VOETGANGERS HIER OVERSTEKEN**

**INGANG**

PP	VIN.	SIGNICOLOR 1,5mm	PP	VIN.	PP	PP	VIN.
300x150	1722.A9	1732.A9	400x250	1723.06	1733.06	400x250	1723.D6
						175x60	1721.85
							1731.85

**UITGANG**

**MELDEN BIJ UITVOERDER**

**VAN MAANDAG TOT VRIJDAG VAN 7 TOT 17 UUR**

**HIER MELDEN**

**RECEPTIE**

PP	VIN.	PP	PP	VIN.	PP	VIN.	PP	VIN.
175x60	1721.E3	1731.E3	300x150	1722.G2	400x250	1723.B7	1733.B7	175x60
								1721.G3
								1731.G3
								1721.J2
								1731.J2

**SECRETARIAAT**

**DIRECTIE**

**BUREEL**

**KANTOOR**

**MAGAZIJN**

PP	VIN.	PP	VIN.	PP	VIN.	PP	VIN.	PP	VIN.
175x60	1721.87	1731.87	175x60	1721.E5	1731.E5	175x60	1721.86	1731.86	175x60
									1721.E4
									1731.E4
									1721.J0
									1731.J0

**VEILIGHEIDSKLEDIJ DRAGEN!**



**ROKERSZONE**

**LAAT DIT LOKAAL IN ONBERISPELIJKE STAAT DE VOLGENDE DANKT U  
LAISSEZ CE LOCAL DANS UN ETAT IMPECCABLE, LE SUIVANT VOUS REMERCIE**

**INTERDIT A TOUTE PERSONNE ETRANGERE AU SERVICE**

PP	VIN.	PP	VIN.	PP	VIN.	VIN.	PP	VIN.
300x150	1722.91	1732.91	175x60	1721.88	1731.88	400x250	1723.A8	1733.A8
								140x90
								1731.89
								400x250
								1723.66
								1733.66

**DEFENSE D'ENTRER SANS MOTIF DE SERVICE**

**CHANTIER INTERDIT AU PUBLIC**

**DEFENSE DE CIRCULER SUR LES TRAVAUX**

**ENTREE**

**DEFENSE DE PASSER SOUS LA CHARGE**

PP	PP	PP	VIN.	VIN.	VIN.	PP
400x250	1723.67	400x250	1723.65	400x250	1723.23	1733.23
						175x60
						1731.J1
						400x250
						1723.68

**BESLOTEN RUIMTE**

**NIET BETREDEN BESLOTEN RUIMTE**

**GEVAAR!**

**IN ONDERHOUD**

**OPGELET HIER GEBEURDE EEN ONGEVAL**

VIN.	VIN.	PP	VIN.	PP	PP
200x100	1731.L3	200x100	1731.L6	100x20	1530.83
				125x50	1521.83
					1531.83
					200x100
					1721.L7
					250x100
					1721.J3

**OPGELET PAS GEVERFD**

**BUITEN DIENST NIET GEBRUIKEN**

**OPGELET AUTOMATISCH STARTENDE INSTALLATIE**

**OPGELET!**  
- STERKE MAGNETISCHE STRALING  
- GEEN VOORWERPEN OP DE TAFEL PLAATSEN  
- DRAADEN OP HOGE TEMPERAATUUR  
- NA UITSCHAKELLEN: 10 MIN. WACHTEN OM AFSCHERMING WEG TE NEMEN  
- ZIE OOK GEBRUIKSAANWIJZING

**ATTENTION!**  
- STRONG MAGNETIC RADIATION  
- DO NOT PUT ANY OBJECTS ON THE TABLE  
- WIRES AT HIGH TEMPERATURE  
- AFTER DISCONNECTING: WAIT ANOTHER 10 MIN. BEFORE REMOVING THE GUARD  
- SEE ALSO INSTRUCTION HANDBOOK

PP	VIN.	PP	VIN.	PP	VIN.	PP
200x100	1721.84	1731.84	200x150	1722.L5	300x100	1722.J4
			240x190	1732.L5		1732.J4
						250x150
						1722.M3
						250x150
						1722.M4

**IN BEDRIJF LATEN A.U.B.**

**BUITEN DIENST HORS SERVICE**

**NIET IN DE MACHINE GRIJPEN WANNEER DEZE IN BEWEGING IS**

**HOOFDSCHAKELAAR**  
**←**  
**INTERRUPTEUR**

**HOOFDSCHAKELAAR**  
**→**  
**INTERRUPTEUR**

VIN.	VIN.	PP	VIN.	VIN.
310x30	1730.L2	300x100	1722.G5	80x40
				175x100
				9733.01
				9732.01
				80x40
				9733.02
				175x100
				9732.02

**HOOFDSCHAKELAAR**  
**—**  
**INTERRUPTEUR**



VIN.	VIN.
80x40	9733.00
175x100	9732.00
120mm	9731.00

# MT - MET UW EIGEN TEKST

# MT - AVEC VOTRE PROPRE TEXTE

HIER UW  
EIGEN TEKST  
ICI VOTRE  
PROPRE TEXTE

HIER UW  
EIGEN TEKST  
ICI VOTRE  
PROPRE TEXTE

HIER UW  
EIGEN TEKST  
ICI VOTRE  
PROPRE TEXTE

HIER UW  
EIGEN TEKST  
ICI VOTRE  
PROPRE TEXTE

PP	VIN.	SIGNICOLOR 1,5mm	PP	VIN.	PP	VIN.	PP	VIN.
200x100	1721.MT	1731.MT	200x100	1721.MTZ	1731.MTZ	175x60	1721.MTA	1731.MTA
400x250	1722.MT	1732.MT	400x250	1722.MTZ	1732.MTZ	175x60	1721.MTG	1731.MTG
400x300	1723.MT	1733.MT	400x300	1723.MTZ	1733.MTZ			



PP	VIN.	SIGNICOLOR 1,5mm	PP	VIN.	SIGNICOLOR 1,5mm	PP	VIN.	SIGNICOLOR 1,5mm	PP
90mm	3221.MT	3231.MT	90mm	3421.MT	3431.MT	90mm	3521.MT	3531.MT	450x150
150mm	322A.MT	323A.MT	200mm	3422.MT	3432.MT	150mm	352A.MT	353A.MT	3425.MT
200mm	3222.MT	3232.MT	300mm	3423.MT	3433.MT	200mm	3522.MT	3532.MT	
300mm	3223.MT	3233.MT	400mm	3424.MT	3434.MT	300mm	3523.MT	3533.MT	
400mm	3224.MT	3234.MT				400mm	3524.MT	3534.MT	

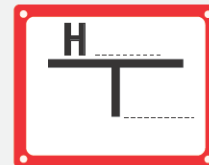

Hier uw eigen tekst  
Ici votre propre texte

Alulook met dubbelzijdige kleefstrook  
Look alu avec adhésif double face

PP	VIN.	PP	PP	VIN.	PP	DIBOND 3mm	PVC1mm
140x200	3222.MTS	3232.MTS	140x200	3422.MTS	140x200	6222.MT	6232.MT
210x300	3224.MTS	3234.MTS			250x200	332L.MT	331L.MT
300x420	3225.MTS	3235.MTS			165x45	4921.MT	



Plexi 6mm - bevestigingen inbegr.  
Plexi 6mm - fixations incl.

PP	VIN.	Spiegelbeeld VIN Image réfléchie	SIGNICOLOR 1,5mm	Muur/Mur	Zijw.R. / Lat.R.	Zijw.R/V / Lat.R/V	Plaf. R.	Plaf. R/V
100x150	4528.58MT	4538.58MT	45A8.58MT	4518.58MT	150x75	5140.MT	5541.MT	5241.MT
210x297	4527.58MT	4537.58MT	45A7.58MT	4517.58MT	150x150	5141.MT	5542.MT	5242.MT
400x600	4526.58MT	4536.58MT	45A6.58MT	4516.58MT	200x200	5142.MT	5543.MT	5243.MT
					300x150	5143.MT		



3D - 3 zijden  
3D - 3 faces



4D - 4 zijden  
4D - 4 faces

Bij de 3D en 4D borden zijn de beugels niet inbegrepen.  
Pour les panneaux 3D et 4D les brides ne sont pas incluses.

Kleuren door te geven bij bestelling  
Couleurs à mentionner à la commande

Alu Plat	Type 2000	Alu Plat
400x400	31Z4.MT	31Y4.MT
		400x400
		31X4.MT

## Kleven

## Coller



- Zelfklevende hechtingsstrip
- Druknopprincipe
- Strip de adhésif
- Principe bouton-poussoir



- Rakel met vilten rand voor applicatie van vinyls op vlakke en lichtgebogen ondergronden
- Raclette avec feutre pour application des vinyles sur surfaces plates et légèrement inclinées

25mmx1mtr DUOTEC

130x80mm B51001



- Dubbelzijdige kleefvellen
- Voor vaste plaatjes
- Gebruik op glad oppervlak
- Feuilles autocollantes double face
- Pour plaques rigides
- Usage sur surface lisse

80x80mm	B93101
130x130mm	B93201
180x180mm	B93301
130x280mm	B93401
180x380mm	B93501



- Dubbelzijdige foamtape
- Rol 33 meter
- Mousse adhésif double face
- Rouleau 33 mètres



- Dubbelzijdige VST tape
- Verhoogde kleefkracht
- 9mm rol 10 meter
- 19mm rol 33 meter



- Dubbelzijdige VHB tape
- Voor toepassingen met aluminium
- Rol 33 meter



12mm PEFOAM



9mm VST09  
19mm VST19

- Adhésif VST double face
- Adhésion élevée
- 9mm rouleau 10 mètres
- 19mm rouleau 33 mètres



15mm HSA15X33  
25mm HSA25X33

- Adhésif VHB double face
- Pour usage avec aluminium
- Rouleau 33 mètres

## Lijmen

## Engluer



Wit  
Blanc

- MS polymeer Wit
- Lijmen en monteren
- 310 ml
- Uniek hechtingsvermogen
- Voor binnen en buiten
- Op natte en droge ondergrond
- Hecht op bijna alle ondergronden
- Hoge UV- en schimmelbestendigheid

- Polymère MS blanc
- Coller et monter
- 310 ml
- Adhérence unique
- Pour l'intérieur et l'extérieur
- Sur des surfaces mouillées et sèches
- Adhère sur la plupart des surfaces
- Haute résistance aux UV et à la moisissure



Lijmspray - Colle en spray  
500ml B52004

Deze lijmspray is geschikt voor het verlijmen van o.a. metaal, rubber en diverse soorten kunststof. Voor zowel permanente als tijdelijke hechting. Snel, doeltreffend en zuinig in gebruik.

La colle en spray convient entre autres au collage du métal, du caoutchouc et de divers types de plastiques. Pour une adhérence permanente et temporaire. Rapide, efficace et économique à utiliser.

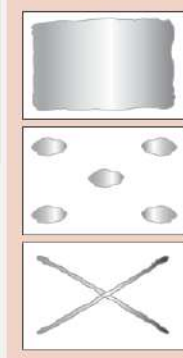

Een correcte verlijming zorgt voor een goede hechting.  
Un collage correct assure une bonne adhérence.

Verhoogde Kleefkracht / Adhésion supérieure TEC7

## Reinigen

## Nettoyer



B52001

### • Surface Cleaner

Oppervlaktereiner zonder solventen, 1 liter  
Voor het ontvetten en reinigen van ondergronden alvorens de folie aan te brengen



B52002

### • Adhesive remover

Voor het verwijderen van lijmresten, 500 ml  
Pour retirer des restes de colle, 500 ml



B52003

### • Graffiti cleaner

Voor het verwijderen van graffiti op alle typen oppervlakken, 1 liter  
Pour retirer du graffiti de tout type de surface, 1 litre



TEC7CLEANER

### • TEC7 remover

Voor het afwerken van lijmnaden en voegen, het reinigen van gereedschappen en het verwijderen van niet-uitgeharde TEC7 lijmen en afdichtingen

Pour la finition des joints, nettoyage des outils et retirer des colles TEC7 non-durcis



SCRAPEX B51002  
Vervangmesjes / Lames de recharge B51003

Nettoyant surface sans solvants, 1 litre  
Pour dégraisser et nettoyer les surfaces avant application du feuille

## Zelfklevend

## Adhésif

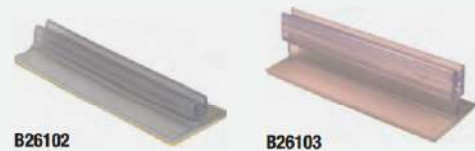

B26102

B26103

- Houder voor muur- of plafondbevestiging
- Voorzien van dubbelzijdige tape

- Support pour fixation murale ou plafond
- Avec adhésif double-face

Afm./Dim.	Dikte/Epp.	
75x12x9mm	1,5mm	B26101
75x25x9mm	1,5mm	B26102
75x25x18mm	3mm	B26103
25x20mm	1,5mm	B26106
75x18mm	1,5mm	B26107
25x12x9mm	3mm	B26108
35x25x18mm	3mm	B26109
15x28x11mm	1,5mm	B26110



B26102



B26102



B26103



B26106

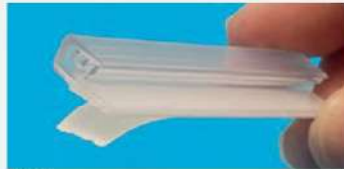

B26107

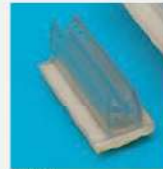

B26108

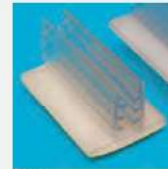

B26109



B26110



20x15mm B26104  
25x27mm B26105

- Houder voor muurbevestiging
- Voor borden met een dikte van max. 1,5mm
- Voorzien van dubbelzijdige tape

- Support pour fixation mural
- Pour panneaux avec une épaisseur de max. 1,5mm
- Avec adhésif double face



B26104

- Gesloten, zelfklevend haakje
- Max. 0,5kg
- Crochet fermé adhésif
- Max. 0,5kg



Kunststof plafonddoog  
Oeillet de plafond en plastique

B16101



Draaibaar plafonddoog 30x30 mm  
Oeillet de plafond pivotant 30x30 mm

B16102

## Zuignap

## Ventouse

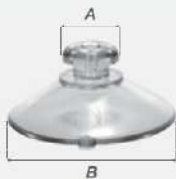

A	B	
8mm	28mm	B16201
14,5mm	40mm	B16202



Metalen haak / crochet en métal	
40mm diam.	B16204
61mm diam.	B16205



Plastic haak / crochet plastique	
36mm	B16207



Met pin / avec punaise	
50mm	B16208
30mm	B16209



25mm

B16203



26mm

Haaks / Drapeau B16206

- Zuignap met houder
- Voor borden met een dikte van max. 1,5mm
- Ventouse avec support
- Pour panneaux avec une épaisseur de max. 1,5mm



Voor kabel / pour cable

B16210

## Ketting

## Chaîne

- Ketting
- Metaal zilverkleurig
- Per meter

- Chaîne
- Métallique argenté
- Par mètre



Ketting 130 zilver per/m  
Chaîne 130 argenté /m

B56101



Kogelketting rvs 2.4mmx100m  
Chaîne à billes inox 2.4mmx100m

B56301



Sluiting kogelketting rvs 2.4mm  
Fermeture chaîne à billes inox 2.4mm

B56302



Staaldraad 150mm met schroefsluiting  
Fil d'acier 150mm avec fermeture à vis

B56303



- Magnetische kunststof plafondhaak ø22 mm
- Neodymium
- Trekkraft tot 15 kg
- Aimant crochet magnétique ø22 mm en plastique
- Neodyme
- Force de traction jusqu'à 15 kg



- Magnetische kunststof plafondhaak ø16 mm
- Neodymium
- Trekkraft tot 1 kg
- Aimant crochet magnétique ø16 mm en plastique
- Neodyme
- Force de traction jusqu'à 1 kg

22mm B16401

16mm B16402

## Niet-Zelfklevend

## Non-adhésif

- Klemveer tot 20mm
- Max. 5kg
- Ressort jusqu'à 20mm
- Max. 5kg



- Kunststof plafondclip met ophangoog
- Clip de plafond en plastique avec oeillet
- Max. 0,5kg

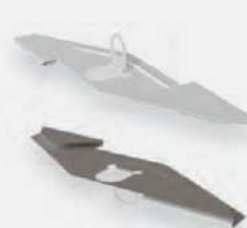

- Draaiklem met ophangoog
- Crochet de torsion avec oeillette suspension
- Voor profiel / pour profile T21 et T35
- Max.: 5kg

B26202

kunststof buisclip 40mm clip de tuyau en plastique

Ø25mm B26304

Ø20mm B26305

19x15mm B26401

B26303



S-haakje Crochet S



S-haakje Crochet S



Karabijnhaak Mousqueton



Verbindingsschakel Connecteur



Nylondraad / Fil nylon 0,3mm

36mm

25mm

50mm

38x24mm

200 meter

B36101

B36102

B36201

K2010

NYLOND



S-haakje Crochet S

25mm

B36103



Metalen displayhaak

Crochet d'affichage en métal

- 40mm B36300
- 60mm B36301
- 100mm B36302
- 150mm B36303
- 300mm B36305
- 500mm B36306
- 1000mm B36308

- Verenstalen spantklem
- Clip en acier à ressort

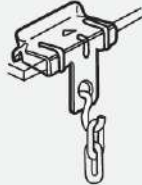

Verticaal / Verticale

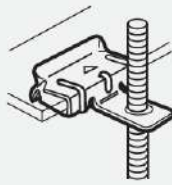

Horizontaal / Horizontale



	Gat / Trou	Verticaal / Verticale	Horizontaal / Horizontale
Prof. 2-3mm	70kg	ø 7mm	B27201
Prof. 3-8mm	90kg	ø 7mm	B27301
Prof. 8-14mm	90kg	ø 7mm	B27401
Prof. 8-14mm	15kg	ø 5mm	B27702
Prof. 14-20mm	90kg	ø 7mm	B27501

- Caddy speed link
- Regelbare kabels op maat



- Caddy speed link
- Câbles réglables sur mesure

	Staal / Acier Galva	RVS / Inox
1,5mmx1mtr	B5731	
1,5mmx2mtr	B5732	B5742
1,5mmx3mtr	B5733	
1,5mmx5mtr	B5734	B5744
1,5mmx10mtr	B5735	B5745



## Afstandhouders

## Fixations avec entretoises



- Verguld
- Muurbevestiging
- Plaatdikte 2-11mm
- Doré
- Entretoise murale
- Epaisseur de panneau 2-11mm

B83003



- Verguld
- Zijwaartse muurbevestiging
- Plaatdikte max. 8mm
- Doré
- Entretoise murale latérale
- Epaisseur de panneau max. 8mm

B83004



- Verguld
- Plafondbevestiging in combinatie met B83006
- Voor bevestiging met kabel B57101
- Doré
- Fixation plafond en combinaison avec B83006
- Pour fixation avec câble B57101

B83005



- Verguld
- Paneelbevestiging in combinatie met B83005 en kabel B57101
- Plaatdikte max. 8mm
- Doré
- Fixation panneau en combinaison avec B83005 et câble B57101
- Epaisseur de panneau max. 8mm

B83006

- Afstandhouders
- Geanodiseerd aluminium
- Binnen- en buitengebruik
- Schroeven en pluggen inbegrepen

- Fixations avec entretoises
- Aluminium anodisé
- Usage intérieur et extérieur
- Vis et chevilles inclus



B81103

- Muurbevestiging
- 10mm diameter
- Plaatdikte 2-15mm
- Boordiameter: 8mm
- Entretoise murale
- 10mm diamètre
- Epaisseur de panneau 2-15mm
- Diamètre de forage: 8mm



B81003

- Muurbevestiging
- 15mm diameter
- Plaatdikte 2-15mm
- Boordiameter: 12mm
- Entretoise murale
- 15mm diamètre
- Epaisseur de panneau 2-15mm
- Diamètre de forage: 12mm



B81203

- Muurbevestiging
- 20mm diameter
- Plaatdikte 2-15mm
- Boordiameter: 12mm
- Entretoise murale
- 20mm diamètre
- Epaisseur de panneau 2-15mm
- Diamètre de forage: 12mm



B81010

- Muurbevestiging
- 20mm diameter
- Plaatdikte 2-6mm
- Geen boring nodig
- Entretoise murale
- 20mm diamètre
- Epaisseur de panneau 2-6mm
- Forage pas nécessaire



PLEXI LINE PAG 189 - 190



B81010



- Zijwaartse muur- of rechtstreekse plafondbevestiging
- 15mm diameter
- Plaatdikte 2-6mm

- Entretoise murale latérale ou plafond en directe
- 15mm diamètre
- Epaisseur de panneau 2-6mm

B81004



- Zijwaartse muur- of rechtstreekse plafondbevestiging
- 15mm diameter
- Plaatdikte max. 1-2mm

- Entretoise murale latérale ou plafond en directe
- 15mm diamètre
- Epaisseur de panneau max. 1-2mm

B81007



- Zijwaartse muur- of rechtstreekse plafondbevestiging
- 20mm diameter
- Plaatdikte 8-12mm

- Entretoise murale latérale ou plafond en directe
- 20mm diamètre
- Epaisseur de panneau 8-12mm

B81204



- Paneelbevestiging in combinatie met B81005
- 15mm diameter
- Plaatdikte max. 6mm

- Fixation panneau en combinaison avec B81005
- 15mm diamètre
- Epaisseur de panneau max. 6mm

B81006



- Paneelbevestiging in combinatie met B81005
- 15mm diameter
- Plaatdikte max. 1-2mm

- Fixation panneau en combinaison avec B81005
- 15mm diamètre
- Epaisseur de panneau max. 1-2mm

B81008



- Paneelbevestiging in combinatie met B81205
- 20mm diameter
- Plaatdikte 8-12mm

- Fixation panneau en combinaison avec B81205
- 20mm diamètre
- Epaisseur de panneau 8-12mm

B81206



- Zijwaartse paneelbevestiging
- 15mm diameter
- Plaatdikte 1-6mm

- Fixation panneau latérale
- 15mm diamètre
- Epaisseur de panneau 1-6mm

B81011



- Plafondbevestiging in combinatie met B81006 of B81011
- 15mm diameter

- Fixation plafond en combinaison avec B81006 of B81011
- 15mm diamètre

B81005



- Plafondbevestiging in combinatie met B81206
- 20mm diameter

- Fixation plafond en combinaison avec B81206
- 20mm diamètre

B81205

# BEVESTIGINGEN

# FIXATIONS

## Afstandhouders

## Fixations avec entretoises



Staalkabel RVS / Câble acier inox



Kabelklem / Serre-câble



RVS Inbusstelschroef kratereind (M4)  
Vis inox pans tête six sans creux bout cuvette (M4)

Per meter / Par mètre		Aluminium	6mm	8mm	10mm
1mm	B57101	B59101	B58001	B58101	B58201
2mm	B57201	B59201			



- RVS
- Muurbevestiging
- 15mm diameter
- plaatdikte 2-14mm
- Inox
- Entretoise murale
- 15mm diamètre
- Épaisseur panneau 2-14mm

B82003



- RVS
- Muurbevestiging
- 30mm diameter
- plaatdikte 2-14mm
- Inox
- Entretoise murale
- 30mm diamètre
- Épaisseur panneau 2-14mm

B82303



Transparant / Transparent

B75001



Zwart / Noir

B75002



Wit / Blanc

B75003

- Holle kunststof afstandsbus
- Opening 5.5mm
- Entretoise cylindrique en plastique
- Trou 5.5mm

## Afdekdoppen en vijzen

## Cache-vis et vis



- Plastic afdekkap voor schroeven Ø4,5mm
- Cache-vis à chapeau pour vis de Ø4,5mm

	Wit / Blanc	Zwart / Noir
Ø 14mm	B70001	B70002



- Houtvijzen
- Gefreesde kop
- In combinatie met B710
- Vis à bois
- Tête fraisée
- En combinaison avec B710

4x16mm	B62101
4x20mm	B62102
4x25mm	B62103
4x30mm	B62104
4x40mm	B62105
4x50mm	B62106
4x65mm	B62107
4x75mm	B62108



- Metalen sierdopjes
- Voor sierschroeven B621
- 2mm dikte
- Cache-vis métal
- Pour vis à bois série B621
- Épaisseur 2mm

	Ø 12mm
Chroomglans / Chromé brillant	B71002
Chroom gesatineerd / Chromé satiné	B71003
Messing glans / Laiton poli	B71004
Messing gesatineerd / Laiton satiné	B71005
Brons / Bronze	B71006



- Vijzen M8
- Verzinkt gecementeerd staal
- Voor reeks B720
- Vis M8
- Acier cémenté zingué
- Pour série B720

6.3mm diam.	
22mm	B62201
35mm	B62301
70mm	B62401
100mm	B62501
125mm	B62601
150mm	B62701



- Aluminium schroefdop zeskant M8
- In combinatie met B62-reeks
- Cache-vis hexagonale en aluminium M8
- En combinaison avec série B62

15mm diam.	Foto	RAL	REF.
Zuiver wit / Blanc pur	1	9010	B72001
Gitzwart / Noir profond	2	9005	B72002
Verkeersrood / Rouge traffic	3	3020	B72003
Hemels blauw / Bleu ciel	4	5015	B72004
Zinkeel / Jaune de zinc	5	1018	B72005
Zandgeel / Jaune sable	6	1002	B72006
Roodbruin / Brun rouge	7	8012	B72007
Ultramarijnblauw / Bleu outremer	8	5002	B72008
Steengrijs / Gris pierre	9	7030	B72009
Blank aluminiumkleurig / Aluminium blanc	10	9006	B72010
Witgrijs / Blanc gris	11	9002	B72011
Ivoor / Ivoire	12	1014	B72012
Resedagroen / Vert reseda	13	6011	B72013



- Afdekdop metaal
- Met sierring
- Voor schroeven max. Ø5mm
- 6mm dikte
- Cache-vis métal
- Avec cuvette
- Pour vis dia max. 5mm
- Épaisseur 6mm

14mm diam.	
Chroom / Chromé	B73101
Messing / Laiton	B73102
Gesatineerd aluminium / Aluminium satiné	B73104
RVS / Acier inoxydable	B73201



Spanringen in inox  
Colliers en inox

Buis / Tuyau Ø	
12-22mm	4750
20-32mm	4751
25-40mm	4752
40-60mm	4753
60-80mm	4754
80-100mm	4755
100-120mm	4756
120-140mm	4757
140-160mm	4758
150-170mm	4759
190-210mm	475A



Spanring verzinkt  
Collier de serrage zingué

Buis / Tuyau Ø	
152mm	B28001





**Bandimex RVS spanband**  
Feuillard Bandimex en acier inoxydable

30mtr.		Voor bandbreedte / Pour largeur de bande	
12,7x0,75mm	B28002A	12,7mm	B28003A
16x0,75mm	B28002B	16mm	B28003B
19x0,75mm	B28002C	19mm	B28003C



**Bandimex RVS sluitzegel**  
Boucle Bandimex en acier inoxydable



**Bandimex spantang**  
Outil de serrage Bandimex

B28004

In combinatie met B28003 en B28004  
En combinaison avec B28003 et B28004

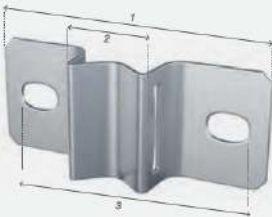

**Bandimex RVS bordhouder**  
Support de panneau Bandimex en acier inoxydable

1	2	3		1	
90mm	50mm	80mm	B28005A	60mm	B28007A
140mm	60mm	120mm	B28005B	100mm	B28007B
200mm	115mm	175mm	B28005C		



**Bandimex RVS Y-beugel 60mm voor verkeersborden**  
Y-support Bandimex en acier inoxydable 60mm pour panneaux de signalisation

voor verkeersborden of rails sb250  
pour panneaux de signalisation ou rails sb250



**Bandimex montagebeugel RVS**  
Support de montage Bandimex en acier inoxydable

met 1 bout / avec 1 boulon M8x16mm	met 2 bouten / avec 2 boulons M8x16mm
B28006A	B28006B

## Bouten

## Douilles



**Keilbout M10 met 1 sluitring**  
Douille expansible M10 avec 1 rondelle

60mm
B67001



**Ankerbout M12 met 1 sluitring**  
Ancre boulon M12 avec 1 rondelle

100mm
B67006



**Asfalbout M10 met 1 sluitring + plug**  
Boulon asphalte M10 1 rondelle + cheville

105mm
B67002



**Keilbout M6 voorzien van oog met 1 sluitring**  
Douille expansible M6 avec oeillet et 1 rondelle

73mm
B67005

### EEN UITGEBREID ASSORTIMENT BEUGELS



PAGINA 232



### NOTRE GAMME DE BRIDES



PAGE 232

## Badgehouder

## Porte badge

Identificeer personeel en bezoekers met een product samengesteld uit badge, badgehouder en gekleurd koord. Elke badgehouder kan voorzien worden van een gekleurd kaartje of nekkoord dat een groep kan identificeren, de reden van het bezoek en het statuut van de bezoeker. De badgehouders beschermen u tegen verlies, vervuiling, fraude en kopiëren naargelang het type of kunnen meerdere kaarten beschermen. Diverse badgehouders hebben zowel een horizontale als verticale functie. het halskoord garandeert de zichtbaarheid van de badges en vergemakkelijkt de presentatie. Gecombineerd met een oprolsysteem geeft u dat een belangrijke flexibiliteit. Personalisatie van de oprolsystemen en halskoorden geeft u een extra PR-communicatie.

Identifier vos visiteurs avec un produit composé d'un badge, d'un porte-badge et corde colorée. Chaque porte-badge peut-être muni d'une carte colorée et corde de nuque qui a la capacité d'identifier un groupe, la raison de la visite et le statut du visiteur. Le porte-badge vous protège contre la perte, le vol, l'encrassement, la fraude et la copie selon le type, ou pour protéger plusieurs cartes. Divers porte-badges ont une fonction horizontale et verticale. La fixation autour du cou vous garantit la visibilité des badges et vous facilite la présentation. Le porte-badge combiné avec un enrouleur vous donne une flexibilité importante. La personnalisation du porte-badge et des cordes vous donne une communication PR extra.

BxH LxH			Aantal kaarten Quantité de cartes		
68x103mm	Soepel Souple	Vertikaal Vertical	1	E20001	
93x82mm	Soepel Souple	Horizontaal Horizontal	1	E20002	
90x68mm	Hard polycarbonaat Mat Polycarbonate dur Sablé	Horizontaal Horizontal	1	E30001	
90x68mm	Hard polycarbonaat Doorschijnend Polycarbonate dur Transparent	Horizontaal Horizontal	1	E30002	
88x57mm	Half-hard polycarbonaat Mat Polycarbonate mi-dur Sablé	Horizontaal Vertikaal Horizontal Vertical	Multi	E30101	
88x57mm	Half-hard polycarbonaat Wit Polycarbonate mi-dur Blanc	Horizontaal Vertikaal Horizontal Vertical	Multi	E30103	



## Halskoord voor badgehouder

## Cordons pour porte-badge

Plat, met plastic haak en breekveiligheid.  
Niet magnetisch

Plat, avec crochet plastique et rupture sécuritaire en cas de tension excessive.  
Non magnétique

Lengte Longueur		
950x9,5mm	Zwart Noir	E10001
950x9,5mm	Blauw Bleu	E10002
950x9,5mm	Rood Rouge	E10003
950x9,5mm	Geel Jaune	E10004
950x9,5mm	Groen Vert	E10005

Mogelijk op maat vanaf 1000 stuks  
Possibilité sur mesure à partir de 1000 pièces

Andere kleuren op aanvraag.  
Autres couleurs sur demande.



## Krokodillenclip

## Pince crocodile



Mat - Versterkt  
Sablé - Renforcé

E50001

Krokodillenclips worden gebruikt voor geperforeerde PVC-kaarten of badgehouders. Bretel-sluitclip voor veilige bevestiging aan uw kleding en dankzij het versterkte vinyl wordt de levensduur verlengd.  
Bandformaat: 70mm  
Vernikkelde clip

Ce type d'attache permet de suspendre un badge perforé ou porte badge à la poche d'un vêtement. La pince crocodile se fixe de manière efficace sur vos vêtements et la sangle en vinyle renforcé rallonge sa durée de vie.  
Longueur de la sangle : 70 mm  
Pince crocodile en métal nickelé

Andere modellen mogelijk op aanvraag  
Autres modèles possibles sur demande



Transparant, met zachte  
geplastificeerde sluiting

Transparent à embout doux plastifié

E50101

Deze transparante krokodillenclip beschikt over een rubberen punt die uw kleding beschermt en goed bevestigd kan worden op veel verschillende textielsoorten.  
Perfect geschikt voor dikke materialen waar standaard clips geen grip op hebben. Voor medewerkers die uniformen dragen van dik materiaal is er eenvoudigweg geen betere clip beschikbaar.  
Bandformaat: 70 mm.  
Bandmateriaal: transparant vinyl  
Vernikkelde clip met zwart-rubberen punt

Cette pince crocodile possède des embouts en caoutchouc qui permettent une fixation délicate sur les vêtements tout en assurant une bonne tenue.  
La pince se montre en outre parfaite pour des matériaux un peu plus épais sur lesquels les clips conventionnels n'adhèrent pas efficacement. Pour les employés portant des uniformes en matières épaisses, cette pince est simplement la meilleure.  
Longueur de la sangle : 70 mm  
Matière de la sangle : vinyle transparent  
Pince crocodile en métal nickelé et embouts caoutchoucs

## Jojo's

## Enrouleurs zip



De karabijnhaak kan bevestigd worden aan riem of tas.

Spoeldiameter 32 mm  
Koordlengte: 762 mm  
Plastic omhulsel met chromen buitenrand  
Transparant vinyl bandje om de badge te bevestigen

L'accroche de type mousqueton s'attachera au boucle de ceinture ou sangle de sac.

Diamètre du zip enrouleur : 32 mm  
Longueur de la corde nylon rétractable : 762 mm  
Enrobage plastique sur un cadre extérieur en métal chromé  
Sangle en vinyle transparent pour attacher le badge

Blauw / Bleu

E401.01



Jojo met oprolbare nylon koord.  
Anti-rotatiesysteem voorkomt dat uw badge zich omdraait.

Spoeldiameter: 32 mm  
Koordlengte: 864 mm.  
Riemclip op achterzijde van de jojo  
Transparant vinyl bandje om badge te bevestigen

Zip enrouleur avec corde nylon rétractable.  
Système anti-rotation afin que votre badge reste toujours sur sa bonne face.

Diamètre de l'enrouleur : 32 mm  
Longueur de la corde : 864 mm.  
Pince de ceinture à glissière au dos.  
Sangle en vinyle transparent pour attacher le badge.

Blauw / Bleu

E402.01



Deze robuuste jojo is vervaardigd uit een extra stevig metalen omhulsel, een duurzaam nylon koord en een versterkt transparant vinyl bandje, bestand tegen extreme omstandigheden. De riemclip kan bevestigd worden aan riem, broekzak of tas.

Spoeldiameter: 38 mm.  
Koordlengte: 588 mm.

Stevige riemclip op de achterkant van de jojo.  
Versterkt vinyl bandje om de badge te bevestigen

Cet enrouleur avec base métallique résistante s'adresse aux environnements de travail les plus durs grâce à son fil d'acier ultra solide et sa sangle en vinyle renforcé. Sa pince de ceinture à glissière au dos assurera une solide attache à votre ceinture, poche ou sac.

Diamètre de l'enrouleur : 38 mm.  
Longueur du fil d'acier rétractable : 588 mm.  
Solide pince de ceinture à glissière au dos de l'enrouleur.  
Sangle en vinyle renforcé pour attacher le badge

Geborsteld metaal / Métal brossé

E403.01

Andere modellen en kleuren mogelijk op aanvraag  
Autres modèles et couleurs possibles sur demande



Wij zorgen voor de opmaak en de productie van uw hoog kwalitatieve badges, prijzen en mogelijkheden op aanvraag.

Nous réalisons le lay-out et production de vos badges en haute qualité, prix et possibilités sur demande.

Helder gepolijst plexiglas 6mm met zandstraallook langs achterzijde.  
Bij recto/verso uitvoeringen worden 2 plexiplaatjes van 3mm  
gescheiden door een speciale witte tussenlaag.

Plexiglas polie clair de 6mm sablé au verso.  
En cas d'exécution recto-verso, nous utilisons 2 plexis sablés de 3mm,  
séparés par une plaque blanche non-translucide.

**MURBEVESTIGING  
FIXATION MURALE**



Ref. vb. foto  
(200x200mm):  
Réf. ex. photo  
(200x200mm):  
5142.80

**MT =**  
met tekst en/of picto naar keuze  
avec texte et/ou picto à votre choix



Ref. vb. foto  
(200x200mm):  
Réf. ex. photo  
(200x200mm):  
5142.MT

**FOTOLUMINESCERENDE UITVOERING  
EXECUTION PHOTOLUMINESCENTE**



Ref. vb. foto  
(200x200mm):  
Réf. ex. photo  
(200x200mm):  
51A2.40

Zijwaartse muur- of rechtstreekse plafondbevestiging  
recto en/of recto/verso uitvoering  
Fixation murale latérale ou fixation directe au plafond  
version recto et/ou recto/verso



Ref. vb. foto  
(200x200mm):  
Réf. ex. photo  
(200x200mm):  
5242.03 (R/V)



Muurbevestiging Fixation murale				Zijwaartse muur- of rechtstreekse plafondbevestiging Fixation murale latérale ou directe au plafond			
		Fotolum / Photolum		Recto		Fotolum / Photolum	
150x75mm	5140...	5140MT	51A0...	51A0MT			55A1... 55A1MT
150x150mm	5141...	5141MT	51A1...	51A1MT	5541...	5541MT	55A2... 55A2MT
200x200mm	5142...	5142MT	51A2...	51A2MT	5542...	5542MT	55A3... 55A3MT
300x150mm	5143...	5143MT	51A3...	51A3MT	5543...	5543MT	
				Recto / Verso		Fotolum / Photolum	
150x150mm				5241...	5241MT	52A1...	52A1MT
200x200mm				5242...	5242MT	52A2...	52A2MT
300x150mm				5243...	5243MT	52A3...	52A3MT

Hoe bestellen: Referentienr. + Nr. picto (Zie pag. 83)

Comment commander N° de référence + N° picto (Voir page 83)

**MT =**  
met tekst en/of picto naar keuze  
avec texte et/ou picto à votre choix

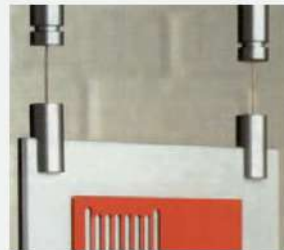

Ref. vb. foto  
Réf. ex. photo (150x150mm):  
5341.41



Ref. vb. foto  
Réf. ex. photo (150x150mm):  
53A1.40



Inclusief / Inclusif  
3 meter / 3 mètres

Plafondbevestiging op afstand / recto of recto/verso uitvoering, met inbegrip van 3m inox kabel  
Fixation au plafond à distance / version recto ou recto/verso, 3m de câble en inox y compris

		Recto		Fotolum / Photolum		Recto / Verso		Fotolum / Photolum	
150x150mm	5341...	5341MT	53A1...	53A1MT	5441...	5441MT	54A1...	54A1MT	
200x200mm	5342...	5342MT	53A2...	53A2MT	5442...	5442MT	54A2...	54A2MT	
300x150mm	5343...	5343MT	53A3...	53A3MT	5443...	5443MT	54A3...	54A3MT	

Hoe bestellen: Referentienr. + Nr. picto (Zie pag. 83)

Comment commander N° de référence + N° picto (Voir page 83)

**Alle picto's worden geleverd met inbegrip van: plexi, symbolen, bevestigingssets, pluggen, vijzen en inox afstandskabel + toebehoren.**

**Tous les pictos sont livrés y compris: plexi, symboles, sets de fixation, chevilles, vis, câble inox et accessoires.**

Andere uitvoeringen en ontwerpen op aanvraag.

Autres exécutions et projets sur demande.



HOUDER VOOR EVACUATIEPLAN A4 / A3  
PORTE-AFFICHE POUR PLAN D'EVACUATION A4 / A3

	FORMAAT / FORMAT PLEXI	FORMAAT / FORMAT PLAN
5644.01	250 x 337mm	A4
5645.01	337 x 460mm	A3

Dikte / Epaisseur plexi : 2x3mm  
Inclusief 4 bevestigingen / Inclusif 4 fixations



Alle picto's worden geleverd met inbegrip van: plexi, symbolen, bevestigingssets, pluggen, vijzen en inox afstandskabel + toebehoren.  
Tous les pictos sont livrés y compris: plexi, symboles, sets de fixation, chevilles, vis, câble inox et accessoires.

Een zeer gebruiksvriendelijk systeem dat toelaat om eenvoudig uw insert te vervangen. Beschikbaar in standaard muurversie, haaks of hangend.  
 Un système à emploi facile qui permet de remplacer l'insert rapidement. Disponible en version murale, en drapeau ou suspendu.

**Geanodiseerd aluminium wandbord - enkelzijdig - zonder insert**  
**Panneau murale en aluminium anodisé - simple face – sans encart**

Buitenmaten / Dimensions extérieures	Insert / Encart	Artikel
104x150	89x150	CA104150
104x210	89x210	CA104210
104x297	89x297	CA104297
104x420	89x420	CA104420
134x150	119x150	CA134150
134x210	119x210	CA134210
134x297	119x297	CA134297
134x420	119x420	CA134420
164x105	149x105	CA164105
164x150	149x150	CA164150
164x210	149x210	CA164210
164x297	149x297	CA164297
164x420	149x420	CA164420
224x150	210x150	CA224150
224x297	210x297	CA224297
312x210	297x210	CA312210
312x420	297x420	CA312420

Een transparant anti-reflecterend PVC plaatje wordt meegeleverd om de insert te beschermen.

Grotere aantallen en andere formaten: prijs op aanvraag.

L'encart est protégé par une feuille PVC antireflets.

Projets et autres dimensions: prix sur demande.

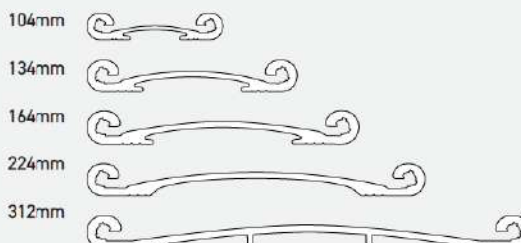

**Geanodiseerd aluminium wandbord - dubbelzijdig haaks – zonder insert**  
**Panneau murale en aluminium anodisé - double face en drapeau – sans encart**

Buitenmaten / Dimensions extérieures	Insert / Encart	Artikel
104x90	89x90	CD10490
134x120	119x120	CD134120
134x240	119x240	CD134240
164x150	149x150	CD164150
164x297	149x297	CD164297
164x150	149x150	CD164150
164x297	149x297	CD164297
224x210	210x210	CD224210

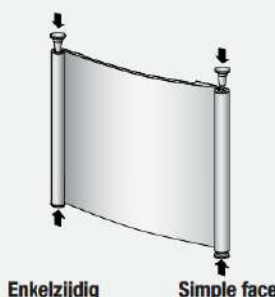

Enkelzijdig

Simple face

**Geanodiseerd aluminium wandbord - dubbelzijdig met ophangset – zonder insert**  
**Panneau murale en aluminium anodisé - double face avec set suspension – sans encart**

Buitenmaten / Dimensions extérieures	Insert / Encart	Artikel
104x420	89x420	CB104420
104x600	89x600	CB104600
134x420	119x420	CB134420
134x600	119x600	CB134600
164x150	149x150	CB164150
164x297	149x297	CB164297
164x600	149x600	CB164600
164x840	149x840	CB164840
224x297	210x297	CB224297
224x600	210x600	CB224600
224x840	210x840	CB224840

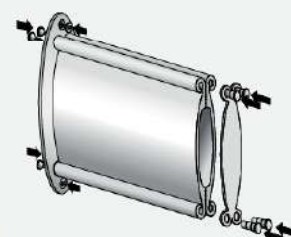

Dubbelzijdig

Double face

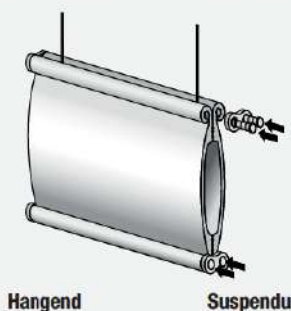

Hangend

Suspendu



Zuignap voor verwijdering kunststof voorzet  
 Ventouse pour retirer le protecteur synthétique

B16301

Een zeer gebruiksvriendelijk systeem dat toelaat om eenvoudig uw insert te vervangen. Beschikbaar in standaard muurversie, haaks of hangend.  
Un système à emploi facile qui permet de remplacer l'insert rapidement. Disponible en version murale, en drapeau ou suspendu.

**Geanodiseerd aluminium wandbord - enkelzijdig - zonder insert**  
**Panneau murale en aluminium anodisé - simple face - sans encart**

Buitenmaten / Dimensions extérieures	Insert / Encart	Artikel
56x75	53x75	PA5675
56x90	53x90	PA5990
56x105	53x105	PA56105
56x150	53x150	PA56150
56x210	53x210	PA56210
56x297	53x297	PA56297
56x420	53x420	PA56420
56x500	53x500	PA56500
78x105	74x105	PA78105
78x150	74x150	PA78150
78x210	74x210	PA78210
78x297	74x297	PA78297
78x420	74x420	PA78420
78x500	74x500	PA78500
78x600	74x600	PA78600
109x105	105x105	PA109105
109x150	105x150	PA109150
109x210	105x210	PA109210
109x297	105x297	PA109297
109x420	105x420	PA109420
109x500	105x500	PA109500
109x600	105x600	PA109600
150x105	148x105	PA150105
150x150	148x150	PA150150
150x210	148x210	PA150210
150x297	148x297	PA150297
150x420	148x420	PA150420
150x500	148x500	PA150500
150x600	148x600	PA150600
212x150	210x150	PA212150
212x210	210x210	PA212210
212x297	210x297	PA212297
212x420	210x420	PA212420
212x500	210x500	PA212500
212x600	210x600	PA212600
212x700	210x700	PA212700
300x210	297x210	PA300210
300x420	297x420	PA300420
300x600	297x600	PA300600
300x700	297x700	PA300700

**Geanodiseerd aluminium wandbord - dubbelzijdig haaks - zonder insert**  
**Panneau murale en aluminium anodisé - double face en drapeau - sans encart**

Buitenmaten / Dimensions extérieures	Insert / Encart	Artikel
109x105	105x105	PB109105
109x150	105x150	PB109150
109x180	105x180	PB109180
109x210	105x210	PB109210
150x150	148x150	PB150150
150x210	148x210	PB150210
150x300	148x297	PB150300
212x210	210x210	PB212210
212x297	210x297	PB212297

**Geanodiseerd aluminium wandbord - dubbelzijdig met ophangset - zonder insert**  
**Panneau murale en aluminium anodisé - double face avec set suspension - sans encart**

**Panneau murale en aluminium anodisé - double face avec set suspension - sans encart**

Buitenmaten / Dimensions extérieures	Insert / Encart	Artikel
109x210	105x210	PD109210
109x300	105x300	PD109300
109x400	105x400	PD190400
109x500	105x500	PD109500
109x600	105x600	PD109600
109x700	105x700	PD109700
109x800	105x800	PD109800
150x300	148x300	PD150300
150x400	148x400	PD150400
150x500	148x500	PD150500
150x600	148x600	PD150600
150x700	148x700	PD150700
150x800	148x800	PD150800
150x840	148x840	PD150840
150x900	148x900	PD150900
212x300	210x300	PD212300
212x400	210x400	PD212400
212x600	210x600	PD212600
212x700	210x700	PD212700
212x800	210x800	PD212800
212x840	210x840	PD212840
212x900	210x900	PD212900
212x1000	210x1000	PD2121000

Een transparant anti-reflecterend PVC plaatje wordt meegeleverd om de insert te beschermen.

Grotere aantallen en andere formaten: prijs op aanvraag.

L'encart est protégé par une feuille PVC antireflets.

Projets et autres dimensions: prix sur demande.

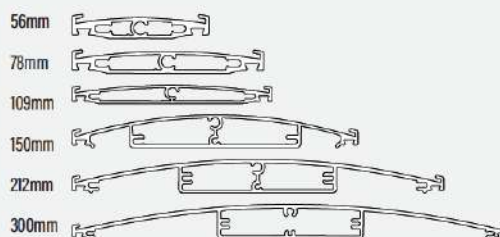

Zuignap voor verwijdering kunststof voorzet  
Ventouse pour retirer le protecteur synthétique

B16301

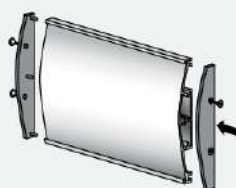

Enkelzijdig  
Simple face

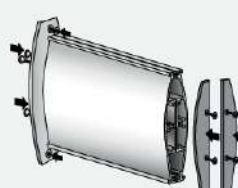

Dubbelzijdig haaks  
Double face en drapeau



Dubbelzijdig hangend  
Double face suspendu

Een veelzijdig aluminium modulair signalisatie-systeem dat afzonderlijk of in combinatie geleverd kan worden. Het product is zo opgebouwd dat uitbreidingen of veranderingen eenvoudig en snel gerealiseerd kunnen worden. Beschikbaar in standaard muurversie, haaks of hangend. De borden worden blanco geleverd, teksten en prints op aanvraag.

Un système universel et modulaire en alu séparément ou en combinaison. Le produit est construit d'une façon telle qu'on peut l'étendre et échanger facilement et rapidement. Disponible en version murale, en drapeau ou suspendu. Les panneaux sont fournies vierges, textes et lay-out sur demande.



**Geanodiseerd aluminium tekstpaneel - enkelzijdig met zwarte eindkappen – zonder print**  
**Panneau texte en aluminium anodisé - simple face avec embouts noirs – sans impression**

	100	125	150	200	250	300	500	600	700	800	1000
15mm	IA15100		IA15150	IA15200	IA15250	IA15300	IA15500	IA15600	IA15700	IA15800	IA151000
31mm	IA31100		IA31150	IA31200	IA31250	IA31300	IA31500	IA31600	IA31700	IA31800	IA311000
62mm	IA62100		IA62150	IA62200	IA62250	IA62300	IA62500	IA62600	IA62700	IA62800	IA621000
93mm	IA93100	IA93125	IA93150	IA93200	IA93250	IA93300	IA93500	IA93600	IA93700	IA93800	IA931000
125mm	IA125100	IA125125	IA125150	IA125200	IA125250	IA125300	IA125500	IA125600	IA125700	IA125800	IA1251000
156mm	IA156100		IA156150	IA156200	IA156250	IA156300	IA156500	IA156600	IA156700	IA156800	IA1561000
187mm	IA187100		IA187150	IA187200	IA187250	IA187300	IA187500	IA187600	IA187700	IA187800	IA1871000
250mm	IA250100		IA250150	IA250200	IA250250	IA250300	IA250500	IA250600	IA250700		

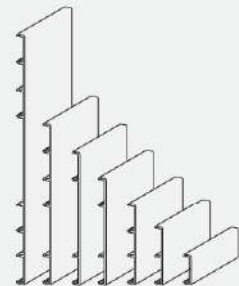

**Geanodiseerd aluminium tekstpaneel - dubbelzijdig met zwarte eindkappen – zonder print**  
**Panneau texte en aluminium anodisé - double face avec embouts noirs – sans impression**

	100	150	200	250	300	500
62mm	IG62100	IG62150	IG62200	IG62250	IG62300	IG62500
93mm	IG93100	IG93150	IG93200	IG93250	IG93300	IG93500
125mm	IG125100	IG125150	IG125200	IG125250	IG125300	IG125500
156mm	IG156100	IG156150	IG156200	IG156250	IG156300	IG156500
187mm	IG187100	IG187150	IG187200	IG187250	IG187300	IG187500
250mm	IG250100	IG250150	IG250200	IG250250	IG250300	IG250500
300mm	IG300100	IG300150	IG300200	IG300250	IG300300	IG300500

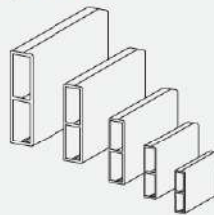

**Geanodiseerd aluminium tekstpaneel - dubbelzijdig met zwarte eindkappen en ophangset – zonder print**  
**Panneau texte en aluminium anodisé - double face avec embouts noirs et set suspension – sans impression**

	100	150	200	250	300	500
62mm	IB62100	IB62150	IB62200	IB62250	IB62300	IB62500
93mm	IB93100	IB93150	IB93200	IB93250	IB93300	IB93500
125mm	IB125100	IB125150	IB125200	IB125250	IB125300	IB125500
156mm	IB156100	IB156150	IB156200	IB156250	IB156300	IB156500
187mm	IB187100	IB187150	IB187200	IB187250	IB187300	IB187500
250mm	IB250100	IB250150	IB250200	IB250250	IB250300	IB250500
300mm	IB300100	IB300150	IB300200	IB300250	IB300300	IB300500

**Geanodiseerd aluminium schuifpaneel - enkelzijdig met zwarte eindkappen – zonder insert**  
**Panneau glissière en aluminium anodisé - simple face avec embouts noirs – sans encart**

	100	150	200	250	300	500	600	700	800	1000
15mm	ID15100	ID15150	ID15200	ID15250	ID15300	ID15500	ID15600	ID15700	ID15800	ID151000
31mm	ID31100	ID31150	ID31200	ID31250	ID31300	ID31500	ID31600	ID31700	ID31800	ID311000
62mm	ID62100	ID62150	ID62200	ID62250	ID62300	ID62500	ID62600	ID62700	ID62800	ID621000
93mm	ID93100	ID93150	ID93200	ID93250	ID93300	ID93500	ID93600	ID93700	ID93800	ID931000

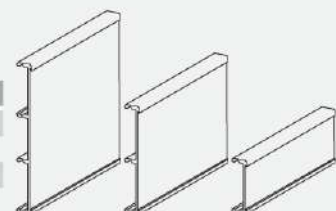

<b>AANWEZIG</b> <b>PRÉSENT</b>	<b>AFWEZIG</b> <b>ABSENT</b>
Marc Ségal	
	Gregory Cleemput
Maarten Peeters	
	Rudy Maes

**Aan-/Afwezig bord**  
**Panneau Present / Absent**

Bord en eindkappen in geanodiseerd aluminium.  
Blanco pvc plaatjes 0.3mm inbegrepen.

Panneau et embouts en aluminium anodisé.  
Plaquettes PVC blanco 0.3mm inclus.

	REF
10 Posities / Positions	IA40.01
15 Posities / Positions	IA50.01
20 Posities / Positions	IA60.01
25 Posities / Positions	IA70.01
30 Posities / Positions	IA80.01
Extra blanco PVC-plaatje Plaque PVC blanco	39M1.00
Extra met naam/foto Avec nom/photo	39M1.MT



**Vrij - Bezet bord**  
**Panneau Libre - Occupé**

Zwart verschuifbaar plaatje inbegrepen.

Plaque noire glissante incluse.

	150x31mm	200x62mm
VRIJ/BEZET	IA10.01	IA20.01
LIBRE/OCCUPE	IA10.02	IA20.02
AANWEZIG/AFWEZIG	IA10.03	IA20.03
PRESENT/ABSENT	IA10.04	IA20.04
MET UW TEKST AVEC VOTRE TEXTE	IA10.MT	IA20.MT



**Deurbord**  
**Panneau porte**

1 tekstpaneel van 31mm en 1 van 62mm hoogte met tekst naar keuze.  
Panelen van 150mm breedte met zwarte kunststof zijkappen.

1 paneel texte de 31mm et 1 de 62mm hauteur avec texte à votre choix.  
Panneau avec une largeur de 150mm et finition synthétique en noir.



**Pyxis**

**Pyxis**

Wandbord bestaande uit een geanodiseerd aluminium profiel en gekleurde eindstukken in polyamide, waardoor een gepersonaliseerde signalisatie naar wens mogelijk is. Een transparant anti-reflecterend PVC plaatje wordt meegeleverd om de insert te beschermen. Voorzien van dubbelzijdige kleefband ter bevestiging. Gepersonaliseerde insert mogelijk op aanvraag.

Panneau murale composé d'un profile en aluminium anodisé et embouts en polyamide coloré, facile pour personnaliser votre signalétique selon vos services. L'encart est protégé par une feuille PVC antireflets. Fixation par adhésif double face (inclus). Encart personnalisé sur demande. \* 5 stuks / 5 pièces

	RAL	100x60mm*	220x150mm	300x220mm
Oranje / Orange	RAL 2000	PY33430	PY33406	PY33400
Grijs / Gris	RAL 7016	PY33431	PY33407	PY33401
Blauw / Bleu	RAL 5005	PY33432	PY33408	PY33402
Groen / Vert	RAL 6011	PY33433	PY33409	PY33403
Paars / Violet	RAL 4001	PY33434	PY33410	PY33404
Rood / Rouge	RAL 3031	PY33435	PY33411	PY33405



**Geschikt voor signalisatie binnen of buiten.**

Wandbord bestaande uit een geanodiseerd aluminium profiel en gekleurde eindstukken in polyamide, waardoor een gepersonaliseerde signalisatie naar wens mogelijk is. Een transparant anti-reflecterend PVC plaatje wordt meegeleverd om de insert te beschermen. Wordt op de muur vastgezet met behulp van haken in roestvrij staal. Bevestigingen niet inbegrepen.

Gepersonaliseerde insert op aanvraag

**Système de signalétique d'intérieur et d'extérieur.**

Panneau murale composé d'un profile en aluminium anodisé et embouts en polyamide coloré, facile pour personnaliser votre signalétique selon vos services. L'encart est protégé par une feuille PVC antireflets. Se fixe au mur avec des pattes en acier inox (visserie non fournie).

Encart personnalisé sur demande.

	RAL	500x100mm	750x100mm	1000x100mm	1250x100mm	1500x100mm
Oranje / Orange	RAL 2000	PY30840	PY30841	PY30842	PY30843	PY30844
Grijs / Gris	RAL 7016	PY30830	PY30831	PY30832	PY30833	PY30834
Blauw / Bleu	RAL 5005	PY30835	PY30836	PY30837	PY30838	PY30839
Groen / Vert	RAL 6011	PY30855	PY30856	PY30857	PY30858	PY30859
Paars / Violet	RAL 4001	PY30845	PY30846	PY30847	PY30848	PY30849
Rood / Rouge	RAL 3031	PY30850	PY30851	PY30852	PY30853	PY30854



I-Sign

I-Sign



Afmetingen/Dimensions	
52x148,5mm	IW52148
105x107mm	IW105107
105x148,5mm	IW105148
105x148,5mm	IW105148S
148,5x150,5mm	IW148150
210x148,5mm	IW210148
210x212mm	IW210212
210x297mm	IW210297
297x210mm	IW297210
297x299mm	IW297299
420x297mm	IW420297
594x420mm	IW594420
841x594mm	IW841594



Afmetingen/Dimensions	
148,5x297mm	IS148297
148,5x420mm	IS148420
148,5x600mm	IS148600
148,5x840mm	IS148840
210x297mm	IS210297
210x420mm	IS210420
210x600mm	IS210600
210x840mm	IS210840



Afmetingen/Dimensions	
150,5x148,5mm	IP150148
212x210mm	IP212210
210x297mm	IP210297
297x210mm	IP297210



Afmetingen/Dimensions	
150x150mm	IFW150150
150x300mm	IFW150300
297x210mm	IFW297210
297x420mm	IFW297420



Afmetingen/Dimensions	
150x150mm	IFS150150
150x300mm	IFS150300



Afmetingen/Dimensions	
150x150mm	IFP150150
150x300mm	IFP150300

# MODULE PLUS OUTDOOR

# MODULE PLUS OUTDOOR

Een opbouwend modulaair signalisatie-systeem dat zorgt voor een stijlvolle bewegwijzering. Uitvoerbaar in een breed gamma aan kleuren en formaten. Prijzen steeds op aanvraag.

Un système modulaire qui permet de placer une signalisation élégante. Réalisable dans une grande gamme de couleurs et dimensions. Prix toujours sur demande.



Standaard



Standard

Met bovenbalk

Avec poutre en haut



Tekstpaneel tussen U-profielen  
Panneau texte entre profiles-U

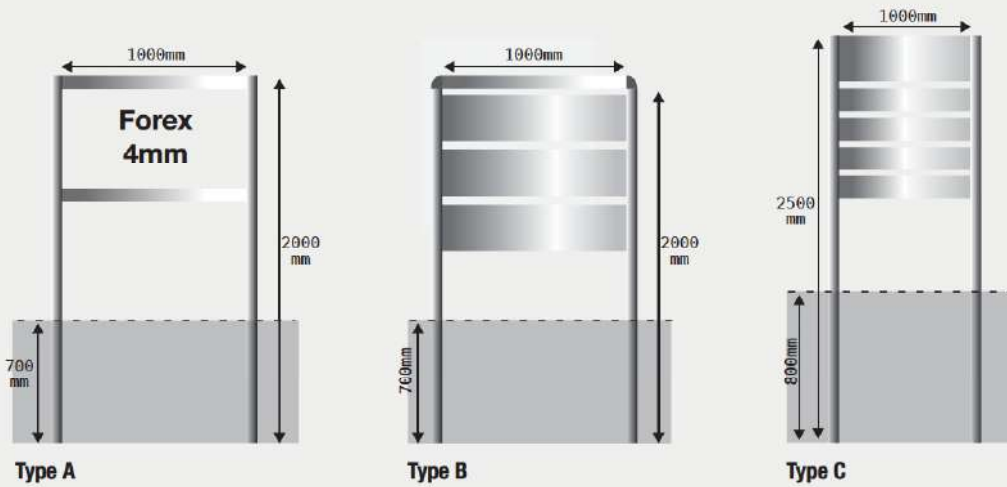

Enkele voorbeelden van opstellingen.  
Quelques exemples de montage.

- Diverse hoogtes tekstpanelen
- Grotere panelen mogelijk met U-profielen
- Ronde of vierkante palen van diverse diktes
- Voetplaten voor palen mogelijk
- Alu anodise of RAL-kleur naar keuze
- Verlichting mogelijk

- Différentes hauteurs panneaux textes
- Grands panneaux possibles avec profiles-U
- Poteaux ronds ou carrés en divers épaisseurs
- Pieds poteaux possibles
- Alu anodisé ou couleur RAL au choix
- Eclairage possible



Probeer in uw prijsaanvraag steeds al de benodigde informatie te vermelden.  
Essayez de mentionner toujours l'info nécessaire dans votre demande de prix.



Met verlichting

Avec éclairage



Gelakte uitvoering

Version laquée



Gekleurd tekstpaneel tussen U-profielen  
Panneau texte coloré entre profiles-U

# OUTDOOR SIGNAGE

Een uitgebreid gamma aan totems, reclamezuilen, gevel- en paalbanieren.

Er is een grote keuze aan formaten en uitvoeringen mogelijk, met of zonder uw personalisatie. Ook de plaatsingen kunnen gerealiseerd worden. Prijzen op aanvraag.

Une gamme vaste de totems, colonnes publicitaires, bannières de façade et poteaux.

Un grand choix de dimensions et systèmes, avec ou sans personnalisation. Installations par notre soin possible.

Prix sur demande.

# OUTDOOR SIGNAGE

OUTDOOR SIGNAGE

- Diverse formaten
- Ovale of vlakke panelen
- Geanodiseerd alu of RAL kleur naar keuze
- Met verlengde constructie of met gelaste voeten
- Verlichting mogelijk



- Différentes dimensions
- Panneaux plats ou ovales
- Alu anodisé ou couleur RAL au choix
- A construction allongée ou pieds soudés
- Eclairage possible

- Diverse formaten
- Muur-, frame- of paalbevestiging
- Geanodiseerd alu of RAL kleur naar keuze
- Met verlengde constructie of met gelaste voeten
- Verlichting mogelijk

- Différentes dimensions
- Fixation murale, sur frame ou sur poteau
- Alu anodisé ou couleur RAL au choix
- A construction allongée ou pieds soudés
- Eclairage possible



OUTDOOR SIGNAGE

# OUTDOOR SIGNAGE

# OUTDOOR SIGNAGE

Een grote keuze aan frames in diverse uitvoeringen. Voor rechtstreekse bevestiging tegen een gevel of voor vrijstaande toepassingen. De ideale manier om op groot formaat uw bedrijf of site te personaliseren. Ook de plaatsingen kunnen gerealiseerd worden. Prijzen op aanvraag.

Un grand choix de frames dans différents variantes. Pour fixer directement contre la façade ou pour des utilisations isolées. La manière idéale pour personnaliser votre entreprise ou site au grand format. Installations par notre soin possible. Prix sur demande.

- Diverse formaten
- Muurbevestiging, hangend of losstaand
- Buizen met koppelsysteem
- Met verlengde constructie of met voeten
- Verlichting mogelijk

- Différentes dimensions
- Fixation murale, suspendue ou isolée
- Tuyaux avec système de fixation
- A construction allongée ou pieds
- Eclairage possible



Roll-up banners voor divers gebruik.

Doordat ze zeer eenvoudig op te bergen zijn heeft u steeds de promotie van uw bedrijf bij de hand. Prijzen op aanvraag.

- Diverse formaten
- Verschillende uitvoeringen
- Verlichting mogelijk

Banners roll-up pour usage divers.

Grâce au rangement économique vous avez toujours la promotion de votre entreprise à portée de main. Prix sur demande.

- Différentes dimensions
- Variété de modèles
- Eclairage possible



### PHOENIX

- Geanodiseerd aluminium kader
- Afgeronde hoeken
- Plexi 3mm
- Draaideur met slot
- Buitendikte: 27mm
- Binnendikte: 11,8mm

- Cadre alu anodisé
- Coins arrondis
- Plexi 3mm
- Porte battante avec serrure
- Epaisseur hors tout: 27mm
- Epaisseur utile: 11,8mm

Afmetingen-BxH Dimensions-LxH	Vln. A4 Fils. A4	Metalen achtergr. Fond métal	Kurken achtergr. Fond liège
260x345mm	1	V29300	V29306
470x345mm	2	V29301	V29307
680x345mm	3 Hor.	V29302	V29308
260x940mm	3 Vert.	V29303	V29309
470x940mm	4	V29304	V29310
470x940mm	6 Vert.	V29305	V29311
680x940mm	6 Hor.	V29313	V29312



### ALYA

- Geanodiseerd aluminium kader
- Afgeronde hoeken
- Gehard glas 4mm
- Draaideur met 1-puntslot
- Buitendikte: 28mm
- Binnendikte: 15mm

- Cadre alu anodisé
- Coins arrondis
- Verre trempé 4mm
- Porte battante avec serrure 1 point
- Epaisseur hors tout: 28mm
- Epaisseur utile: 15mm

Afmetingen-BxH Dimensions-LxH	Vln. A4 Fils. A4	Metalen achtergr. Fond métal	Kurken achtergr. Fond liège
310x395mm	1	V29601	V29620
520x395mm	2	V29602	V29621
520x695mm	4	V29604	V29614
730x695mm	6	V29606	V29616
730x990mm	9	V29609	V29619



### ALGOL

- Geanodiseerd aluminium kader
- Afgeronde hoeken
- Gehard glas 4mm
- Schuiframen op kogellagers
- Buitendikte: 50mm
- Binnendikte: 20mm
- Verlichting niet inbegrepen
- Met veiligheidslot

- Cadre alu anodisé
- Coins arrondis
- Verre trempé 4mm
- Glaces coulissantes sur roulements à billes
- Epaisseur hors tout: 50mm
- Epaisseur utile: 20mm
- Eclairage non-incluse
- Avec serrure de sécurité

Afmetingen-BxH Dimensions-LxH	Vln. A4 Fils. A4	Metalen achtergr. Fond métal	Kurken achtergr. Fond liège
925x675mm	8	V29010	V29016
1135x675mm	10	V29011	V29017
1345x675mm	12	V29012	V29018
1135x975mm	15	V29013	V29019
1345x975mm	18	V29014	V29020
1555x975mm	21	V29022	V29024
1675x975mm	24	V29023	V29025
1975x975mm	27	V29015	V29021



Doos/Boîte: 100 punaises

V16909

### ALUDRA

- Geanodiseerd aluminium kader
  - Plexi 4mm
  - Draaideur met met 2-puntsveiligheidsslot
  - Buitendikte: 44mm
  - Binnendikte: 24mm
- Cadre alu anodisé
  - Plexi 4mm
  - Porte battante avec serrure de sécurité à 2 points
  - Epaisseur hors tout: 44mm
  - Epaisseur utile: 24mm

Afmetingen-BxH Dimensions-LxH	Vltn. A4 Fils. A4	Grijs metalen achtergrond Fond métal gris	Kurken achtergrond Fond liège
530x710mm	4	V29005	V29000
740x710mm	6	V29006	V29001
740x1010mm	9	V29007	V29002
950x1010mm	12	V29008	V29003
1160x1010mm	15	V29009	V29004



### ALUDRA Sleutelvitriene - Vitriene clés

- Geanodiseerd aluminium kader
  - Afgeronde hoeken
  - Gehard glas 4mm
  - Draaideur met met 2-puntsveiligheidsslot
  - Buitendikte: 44mm
  - Binnendikte: 24mm
- Cadre alu anodisé
  - Coins arrondis
  - Verre trempé 4mm
  - Porte battante avec serrure de sécurité à 2 points
  - Epaisseur hors tout: 44mm
  - Epaisseur utile: 24mm

Afmetingen-BxH Dimensions-LxH	Sleutelvitriene voor 98 sleutels Vitriene porte-clés pour 98 clés
740x710mm	V29041

25st. Gekleurde sleutelhangers  
25 pcs. Porte-clés colorés

V29045

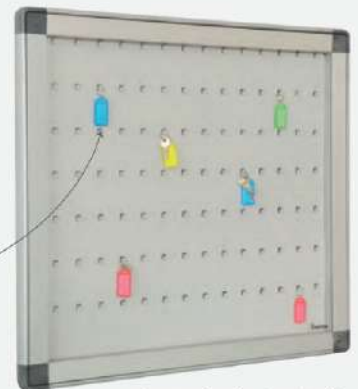

Voor 98 sleutels - Pour 98 clés

## ANTARES - Draaideur - Porte battante

- Geanodiseerd of gelakt aluminium kader
- Afgeronde hoeken
- Plexi of gehard glas 4mm
- Draaideur met 2-puntsveiligheidsslot
- Buitendikte: 44mm
- Binnendikte: 24mm
- Cadre alu anodisé ou laqué
- Coins arrondis
- Plexi ou verre trempé 4mm
- Porte battante avec serrure de sécurité à 2 points
- Epaisseur hors tout: 44mm
- Epaisseur utile: 24mm

### Gehard glas - Verre trempé

Afmetingen-BxH Dimensions-LxH	Vln. A4 Fils. A4	RAL 1019 Zandkl. Sable	RAL 7005 Grijs Gris	RAL 3011 Rood Rouge	RAL 5000 Blauw Bleu	ALU Alu anod. Alu anod.
535x710mm	4	V29100	V29106	V29112	V29118	V29124
745x710mm	6	V29101	V29107	V29113	V29119	V29125
745x1005mm	9	V29102	V29108	V29114	V29120	V29126
955x1005mm	12	V29103	V29109	V29115	V29121	V29127

### Plexi

Afmetingen-BxH Dimensions-LxH	Vln. A4 Fils. A4	RAL 1019 Zandkl. Sable	RAL 7005 Grijs Gris	RAL 3011 Rood Rouge	RAL 5000 Blauw Bleu	ALU Alu anod. Alu anod.
535x710mm	4	V29A00	V29A06	V29A12	V29A18	V29A24
745x710mm	6	V29A01	V29A07	V29A13	V29A19	V29A25
745x1005mm	9	V29A02	V29A08	V29A14	V29A20	V29A26
955x1005mm	12	V29A03	V29A09	V29A15	V29A21	V29A27



## ANTARES - Liftdeur - Porte levante

- Geanodiseerd of gelakt aluminium kader
- Afgeronde hoeken
- Plexi 4mm
- Liftdeur met 2 gasveren en 2-puntsveiligheidsslot
- Buitendikte: 44mm
- Binnendikte: 24mm
- Cadre alu anodisé ou laqué
- Coins arrondis
- Plexi 4mm
- Porte levante assistée par 2 vérins à gaz avec serrure de sécurité à 2 points
- Epaisseur hors tout: 44mm
- Epaisseur utile: 24mm

Afmetingen-BxH Dimensions-LxH	Vln. A4 Fils. A4	RAL 1019 Zandkl. Sable	RAL 7005 Grijs Gris	RAL 3011 Rood Rouge	RAL 5000 Blauw Bleu	ALU Alu anod. Alu anod.
955x1005mm	12	V29141	V29142	V29143	V29144	V29145
1165x1005mm	15	V29161	V29162	V29163	V29164	V29165
1375x1005mm	18	V29104	V29110	V29116	V29122	V29128
1585x1005mm	21	V29171	V29172	V29173	V29174	V29175
1795x1005mm	24	V29105	V29111	V29117	V29123	V29129



## ANTARES - Dubbelzijdig staand - Double sur piétement

- Geanodiseerd of gelakt aluminium kader en palen Ø50mm
- Afgeronde hoeken
- Buitendikte: 44mm
- Binnendikte: 24mm
- Hoogte boven maaiveld: 1800mm
- Bevestiging: 400mm in de grond
- Cadre et poteaux Ø50mm alu anodisé ou laqué
- Coins arrondis
- Epaisseur hors tout: 44mm
- Epaisseur utile: 24mm
- Hauteur hors-sol: 1800mm
- Scellement: 400mm dans le sol
- Glas 4mm
- Draaideur met 2-puntsveiligheidsslot
- Verre 4mm
- Porte battante avec serrure de sécurité à 2 points

Afmetingen-BxH Dimensions-LxH	Vln. A4 Fils. A4	RAL 1019 Zandkl. Sable	RAL 7005 Grijs Gris	RAL 3011 Rood Rouge	RAL 5000 Blauw Bleu	ALU Alu anod. Alu anod.
740x1010mm	9	V29802	V29808	V29814	V29820	V29826

- Plexi 4mm
- Liftdeur met 2 gasveren en 2 veiligheidsloten
- Plexi 4mm
- Porte levante assistée par 2 vérins à gaz avec 2 serrures de sécurité

Afmetingen-BxH Dimensions-LxH	Vln. A4 Fils. A4	RAL 1019 Zandkl. Sable	RAL 7005 Grijs Gris	RAL 3011 Rood Rouge	RAL 5000 Blauw Bleu	ALU Alu anod. Alu anod.
950x1010mm	12	V29803	V29809	V29815	V29821	V29827
1370x1010mm	18	V29804	V29810	V29816	V29822	V29828
1790x1010mm	24	V29805	V29811	V29817	V29823	V29829



De vitrines zijn ook beschikbaar in andere kleuren.

Les vitrines sont également disponibles en d'autres couleurs.

### ANTARES - Enkelzijdig staand - Simple sur piétement

- Geanodiseerd of gelakt aluminium kader en palen Ø50mm
- Afgeronde hoeken
- Plexi 4mm
- Liftdeur met 2 gasveren en 2-puntsveiligheids slot
- Buitendikte: 44mm
- Binnendikte: 24mm
- Hoogte boven maaiveld: 1800mm
- Bevestiging: 400mm in de grond
- Cadre et poteaux Ø50mm alu anodisé ou laqué
- Coins arrondis
- Plexi 4mm
- Porte levante assistée par 2 vérins à gaz avec serrure de sécurité à 2 points
- Epaisseur hors tout: 44mm
- Epaisseur utile: 24mm
- Hauteur hors-sol: 1800mm
- Scellement: 400mm dans le sol



Afmetingen-BxH Dimensions-LxH	Vln. A4 Fils. A4	RAL 1019 Zandkl. Sable	RAL 7005 Grijs Gris	RAL 3011 Rood Rouge	RAL 5000 Blauw Bleu	ALU Alu anod. Alu anod.
950x1010mm	12	V29203	V29209	V29215	V29221	V29227
1370x1010mm	18	V29204	V29210	V29216	V29222	V29228
1790x1010mm	24	V29205	V29211	V29217	V29223	V29229

### ANTARES - Met verlichting - Éclairé

- Geanodiseerd of gelakt aluminium kader
- Afgeronde hoeken
- Plexi 4mm
- Draaideur met 2-puntsveiligheids slot
- Buitendikte: 44mm
- Binnendikte: 24mm
- 2 LED strips
- Cadre alu anodisé ou laqué
- Coins arrondis
- Plexi 4mm
- Porte battante avec serrure de sécurité à 2 points
- Epaisseur hors tout: 44mm
- Epaisseur utile: 24mm
- 2 réglettes LED



Aansluiting en transformator zijn geïntegreerd in de vitrine en moeten door een vakman op het elektriciteitsnet aangesloten worden.  
Connecteur et transformateur intégrés à l'intérieur de la vitrine. Elle sera raccordée au réseau électrique par un professionnel.

Afmetingen-BxH Dimensions-LxH	Vln. A4 Fils. A4	RAL 1019 Zandkl. Sable	ALU Alu anod. Alu anod.
540x770mm	4	V29930	V29934
750x770mm	6	V29940	V29944
750x1070mm	9	V29950	V29954

### ALCYONE

- Geanodiseerd aluminium kader
- Afgeronde hoeken
- Gehard glas 4mm
- Draaideur met 1-punt slot
- Buitendikte: 28mm
- Binnendikte: 15mm
- Cadre alu anodisé
- Coins arrondis
- Verre trempé 4mm
- Porte battante avec serrure 1 point
- Epaisseur hors tout: 28mm
- Epaisseur utile: 15mm



Uitneembare deur vergemakkelijkt de bevestiging van de vitrine. De deur kan in geval van schade gemakkelijk vervangen worden.  
Charnière amovible, facilitant la pose de la vitrine et la maintenance. Sa conception permet un changement de la porte sans démonter la vitrine en cas de bris de verre.

Afmetingen-BxH Dimensions-LxH	Vln. A4 Fils. A4	Metalen achtergrond Fond métal
310x395mm	1	V29701
520x395mm	2	V29702
520x695mm	4	V29704
730x695mm	6	V29706
730x990mm	9	V29709

### ALCOR

- Geanodiseerd of gelakt aluminium kader
- Afgeronde hoeken
- Plexi 3mm
- Draaideur met 1 veiligheidsslot
- Buitendikte: 33mm
- Binnendikte: 16mm
- Cadre alu anodisé ou laqué
- Coins arrondis
- Plexi 3mm
- Porte battante avec 1 serrure de sécurité
- Epaisseur hors tout: 33mm
- Epaisseur utile: 16mm

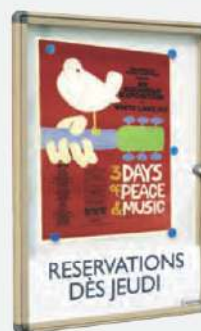

Afmetingen-BxH Dimensions-LxH	Vln. A4 Fils. A4	RAL 1019 Zandkl. Sable	RAL 7005 Grijs Gris	RAL 3011 Rood Rouge	RAL 5000 Blauw Bleu	ALU Alu anod. Alu anod.
260x350mm	1	V29400	V29401	V29402	V29403	V29418
470x350mm	2	V29404	V29405	V29406	V29407	V29419
470x650mm	4	V29412	V29413	V29414	V29415	V29420
700x550mm	650x500mm	V29408	V29409	V29410	V29411	V29421

- Zilver geanodiseerd
- Aluminium profielen
- Glas
- Opent langs achterzijde
- Binnengebruik

Afmetingen-BxH	Prof. 25mm
Dimensions-LxH	Prof. 25mm
DIN A4 - 210x297mm	POSTER1
DIN A3 - 297x420mm	POSTER2
DIN A2 - 420x594mm	POSTER3
DIN A1 - 594x841mm	POSTER4
DIN B2 - 500x707mm	POSTER5

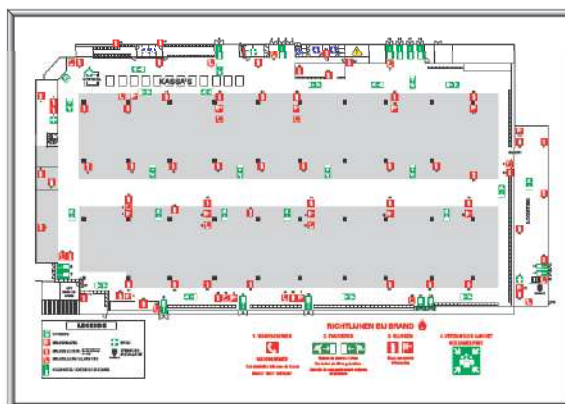

- Anodisé argent
- Profiles en aluminium
- Verre
- S'ouvre au dos
- Usage intérieur

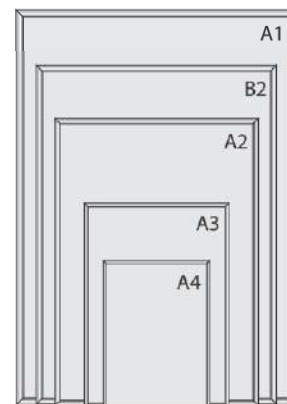

## Affichedrager

- A4 document bovenaan inschuiven
- Voorzien van dubbelzijdige kleefband
- Verkocht per paar
- Binnengebruik

Zelfklevende minivitrine A4 / Porte-affiche A4 adhésif  
V28760

- Le document A4 se glisse en haut
- Fixation adhésive
- Vendues par paire
- Usage intérieur

## Porte-affiches

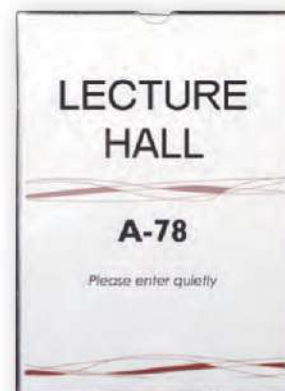

Indoor

Indoor

Zilver geanodiseerd

Anodisé naturel

• Aluminium profielen • Anti-reflecterende beschermfolie

• Profiles en alu • Film de protection anti-reflet

CLICFRAMES

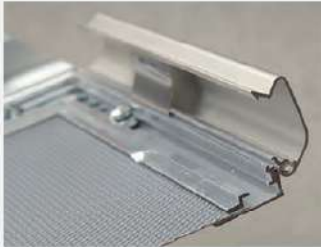

Almetingen-BxH Dimensions-LxH	Prof. 25mm Prof. 25mm	Prof. 25mm Prof. 25mm	Prof. 32mm Prof. 32mm	Prof. 32mm Prof. 32mm
DIN A5-148x210mm	CLIC19	CLIC20		
DIN A4-210x297mm	CLIC01	CLIC07		
DIN A3-297x420mm	CLIC02	CLIC08	CLIC40	CLIC21
DIN A2-420x594mm	CLIC03	CLIC09	CLIC41	CLIC13
DIN A1-594x841mm	CLIC04	CLIC10	CLIC43	CLIC14
DIN A0-841x1189mm			CLIC45	CLIC15
DIN B2-500x700mm	CLIC05	CLIC11	CLIC42	CLIC16
DIN B1-700x1000mm	CLIC06	CLIC12	CLIC44	CLIC17

Rood gelakt RAL3020

• Aluminium profielen  
• Anti-reflecterende beschermfolie

Rouge laqué RAL3020

• Profiles en alu  
• Film de protection anti-reflet



Almetingen-BxH Dimensions-LxH	Prof. 20mm Prof. 20mm	Prof. 25mm Prof. 25mm
DIN A4-210x297mm	CLIC51	CLIC61
DIN A3-297x420mm	CLIC52	CLIC62
DIN A2-420x594mm	CLIC53	CLIC63

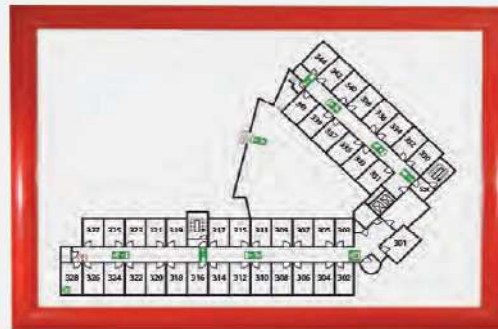

Afsluitbare klikkaders

• Aluminium profielen  
• Anti-reflecterende beschermfolie  
• Inbussleutel inbegrepen

Cadres clic-clac verrouillable

• Profiles en alu  
• Film de protection anti-reflet  
• Clé allen incluse



Almetingen-BxH Dimensions-LxH	Prof. 32mm Prof. 32mm
DIN A4-210x297mm	CLIC90
DIN A3-297x420mm	CLIC91
DIN A2-420x594mm	CLIC92
DIN A1-594x841mm	CLIC93
DIN A0-841x1189mm	CLIC94
DIN B2-500x700mm	CLIC95
DIN B1-700x1000mm	CLIC96

Security klikkaders

• Aluminium profielen met stevige profielveren  
• Anti-reflecterende beschermfolie  
• Kunststof sleutel niet inbegrepen

Security cadres clic-clac

• Profiles en aluminium à ressorts solides  
• Film de protection anti-reflet  
• Clé synthétique non-incluse

CLICFRAMES

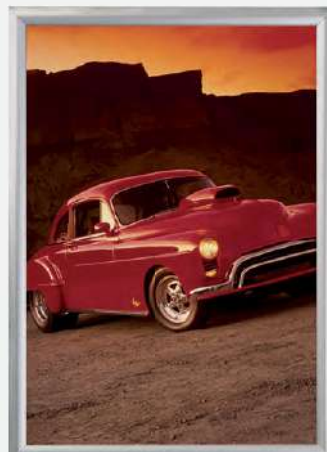

Almetingen-BxH Dimensions-LxH	Prof. 25mm Prof. 25mm
DIN A2-420x594mm	CLIC133
DIN B2-500x700mm	CLIC136
DIN A1-594x841mm	CLIC134
DIN B1-700x1000mm	CLIC137
DIN A0-841x1189mm	CLIC135
Kunststof sleutel	KEY8
Clé synthétique	

# KLIKKADERS

# CADRES CLIC-CLAC

## LED Clicframe

- Aluminium profielen
- Anti-reflecterende beschermingsfolie
- Met LED verlichting
- Adapter inbegrepen



## Clicframe LED

- Profiles en alu
- Film de protection anti-reflet
- Avec éclairage LED
- Adaptateur inclus



Afmetingen-BxH Dimensions-LxH	Prof. 25mm Prof. 25mm
DIN A4-210x297mm	CLIC100
DIN A3-297x420mm	CLIC101
DIN A2-420x594mm	CLIC102
DIN A1-594x841mm	CLIC103
DIN A0-841x1189mm	CLIC104
DIN B2-500x700mm	CLIC105
DIN B1-700x1000mm	CLIC106

## Windowframe

- Aluminium profielen
- Om aan de binnenzijde van een raam te kleven
- Met buitenafwerking



## Windowframe

- Profiles en alu
- A coller à l'intérieur d'une fenêtre
- Avec finition extérieure



Afmetingen-BxH Dimensions-LxH	Prof. 25mm Prof. 25mm
DIN A4-210x297mm	CLIC70
DIN A3-297x420mm	CLIC71
DIN A2-420x594mm	CLIC72
DIN A1-594x841mm	CLIC73
DIN A0-841x1189mm	CLIC74
DIN B2-500x700mm	CLIC75
DIN B1-700x1000mm	CLIC76

## Outdoor

- Aluminium profielen
- Anti-reflecterende beschermingsfolie
- Met inbussleutel
- Waterproof
- Profiles en alu
- Film de protection anti-reflet
- Avec clé allen
- Imperméable



Afmetingen-BxH Dimensions-LxH	Prof. 25mm Prof. 25mm
DIN A3-297x420mm	CLIC112
DIN A2-420x594mm	CLIC113
DIN A1-594x841mm	CLIC114
DIN A0-841x1189mm	CLIC115
DIN B2-500x700mm	CLIC116
DIN B1-700x1000mm	CLIC117



- Aluminium profielen
- Anti-reflecterende beschermingsfolie
- Zonder sleutel
- Waterproof



- Profiles en alu
- Film de protection anti-reflet
- Sans clé
- Imperméable



Afmetingen-BxH Dimensions-LxH	Prof. 25mm Prof. 25mm
DIN A4-210x297mm	CLIC121
DIN A3-297x420mm	CLIC122
DIN A2-420x594mm	CLIC123
DIN A1-594x841mm	CLIC124
DIN B2-500x700mm	CLIC126
DIN B1-700x1000mm	CLIC127

## Stoepborden



- Dubbelzijdig
- Gew. 12kg
- Double face
- Poids 12kg

A1

0107.01



- Dubbelzijdig
- Met veren op watertank
- Double face
- Avec ressorts sur réservoir à eau

A1

A0

0108.01 0109.01



- Dubbelzijdig
- Met veren op onderstel
- Double face
- Avec pieds ressorts

A1

A0

0110.01 0111.01

# MEDEDELINGSBORDEN

# TABLEAUX D'AFFICHAGE

## Magneetborden

## Tableaux magnétiques

### LAVAGNA

Afmetingen-BxH Dimensions-LxH	Email Email	Gelakt Laque
600x450mm	V19101	V19161
900x600mm	V19102	V19162
1200x900mm	V19103	V19163
1800x900mm	V19104	V19164
1500x1000mm	V19110	V19170
2000x1000mm	V19100	
1500x1200mm	V19105	V19165
1800x1200mm	V19106	V19166
2000x1200mm	V19112	
2100x1200mm	V19107	V19167
2400x1200mm	V19108	
3000x1200mm	V19109	
4000x1200mm*	V19111	

\* Geleverd in 2 delen  
Livré en 2 pièces



- Geanodiseerd aluminium kader
- Klikbare afleggoot 300mm
- Bevestigingen inbegrepen
- Droog uitwisbaar
- Dikte: 16mm
- Cadre alu anodisé
- Auget de 300mm encliquetable
- Fixations incluses
- Effaçable à sec
- Epaisseur: 16mm

### CALAMITA

Afmetingen-BxH Dimensions-LxH	Email Email
1200x900mm	V34008
1200x1000mm	V34009
1500x1000mm	V34011
2000x1000mm	V34000
3000x1000mm	V34013
1500x1200mm	V34001
2000x1200mm	V34010
2400x1200mm	V34004
3000x1200mm	V34005
4000x1200mm*	V34006

\* Geleverd in 2 delen  
Livré en 2 pièces

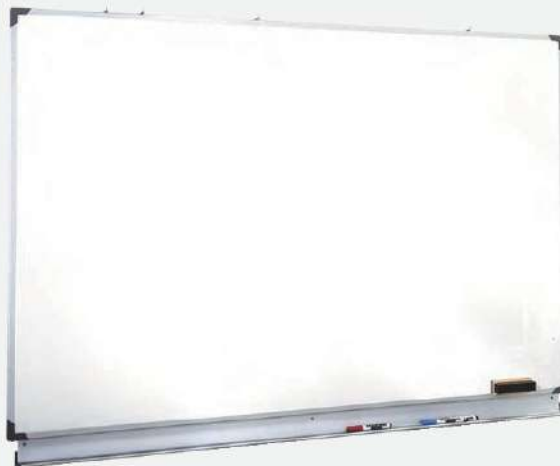

- Geanodiseerd aluminium kader
- Afleggoot over de hele breedte
- Droog uitwisbaar
- Dikte: 10mm
- Kaartendrager haken geïntegreerd in het bovenste profiel.
- Cadre alu anodisé
- Auget porteur sur toute la longueur
- Effaçable à sec
- Epaisseur: 10mm
- Crochets porte-carte intégrés dans le profil supérieur

### VETRO

Afmetingen-BxH Dimensions-LxH	Wit Blanc
900x600mm	V20730
1200x900mm	V20731
1500x1000mm	V20732



- Gehard glas
- Wordt geleverd met glazen afleggoot, bordenwisser en 5 magneten
- Bevestigingen inbegrepen
- Droog uitwisbaar
- Dikte: 3mm
- Verre trempé
- Livré avec auget en verre, 1 brosse d'effaçage et 5 aimants
- Fixations incluses
- Effaçable à sec
- Epaisseur: 3mm

## ROVESCIAATO



- Horizontaal kantelbaar
- Geanodiseerd aluminium omlijsting
- Afleggoot over de hele breedte
- Voetstuk met 4 wielen met rem, hoogte 1400mm
- Dubbelzijdig
- Droog uitwisbaar
- Diepte: 550mm
- Rotatief axe horizontal
- Cadre alu anodisé
- Auget sur toute la longueur
- Piétement sur 4 roulettes à frein, hauteur 1400mm
- Double face
- Effaçable à sec
- Profondeur: 550mm

Afmetingen-BxH Dimensions-LxH	Email	Gelakt Laqué
1200x900mm	V19203	V19205
1800x900mm	V19204	V19206
1500x1200mm	V19210	V19211

## AGGIUNTIVO

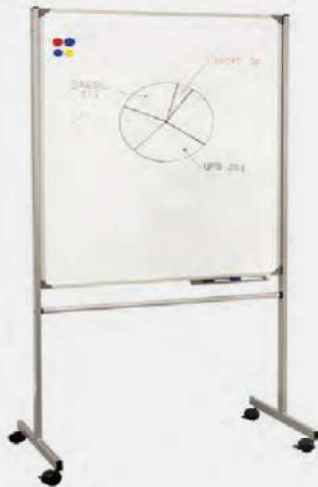

- Geanodiseerd aluminium omlijsting
- Afleggoot 300mm
- Dubbelzijdig
- Droog uitwisbaar
- Voetstuk met 4 wielen met rem
- Cadre alu anodisé
- Auget 300mm
- Double face
- Effaçable à sec
- Piétement sur 4 roulettes à frein

Afmetingen-BxH Dimensions-LxH	Email
1200x900mm	V22530
1800x900mm	V22531

## Toebehoren

## Accessoires



**Uitwisbare stiften**  
Feutres effaçables

Zwart/Noir

MARKERZ



**Uitwisbare stiften**  
Feutres effaçables

Set van 4 stuks:  
1x zwart + 1x groen + 1x blauw + 1x rood  
Set de 4 pièces:  
1x noir + 1x vert + 1x bleu + 1x rouge

V22100



**Magnetische bordenwisser**  
Brosse d'effaçage magnétique

V22116

Vulling 10 stuks  
Recharge de 10 pièces

V22117



**Starterskit**  
Kit de départ

V22115

- 4 viltstiften (zwart, blauw, rood, groen)
- 1 magnetische bordenwisser met 10 wisserdoekjes
- 1 reinigingspray 250ml
- 6 gekleurde magneten
- 4 marqueurs (noir, rouge, bleu, vert)
- 1 brosse d'effaçage magnétique et 10 recharges en feutre
- 1 bombe de nettoyage 250ml
- 6 aimants colorés



**Magneten - 10 stuks**  
Aimants - 10 pièces

Ø	20mm	30mm
Sterkte/Force	250gr	850gr
Zwart/Noir	MA701	MA711
Rood/Rouge	MA702	MA712
Blauw/Bleu	MA703	MA713
Groen/Vert	MA704	MA714



**Magnetische haak**  
Patère magnétique



**Bevestigingsmagneet**  
Aimant de fixation

60x60mm MAA5

De standaard richtlijn voor een wandbord is 1 magneet per 0,30 m<sup>2</sup>

Donnée indicative pour un tableau est 1 aimant pour 0,30 m<sup>2</sup>

# MEDEDELINGSBORDEN

# TABLEAUX D'AFFICHAGE

Kurkborden

Tableaux en liège

## SUGHERO

Doos/Boîte: 100 punaises



V16909



Afmetingen-BxH Dimensions-LxH	
600x450mm	V16050
900x600mm	V16052
1200x900mm	V16054
1800x900mm	V16062
1500x1200mm	V16056
2000x1200mm	V16058

- Geanodiseerd aluminium kader
- Rechte hoeken
- Dikte: 16mm
- Kan zowel verticaal als horizontaal opgehangen worden
- Cadre aluminium anodisé
- Coins droits
- Epaisseur: 16mm
- Suspension dans les deux sens

## BROCHURE- EN TAGHOUDERS



- Beschikbaar in wand- en tafelmodellen
- Bevestigingen niet inbegrepen
- Disponible en version murale et table
- Fixations non-incluses

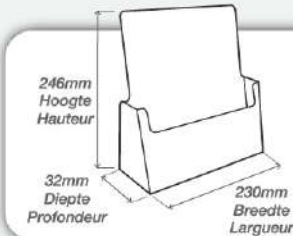

De aangegeven formaten betreffen telkens de binnenmaten.

Les dimensions mentionnées concernent toujours les dimensions intérieures.



## PORTE-BROCHURES ET TAGS



### Tafelmodel

### Modèle table



1/3 A4

BxHxL/LxHxP 110x178x32mm

BR001



A5

160x211x32mm

BR002



A4

230x246x32mm

BR003



2 x 1/3 A4

(2x)110x246x32mm

BR011



2 x 1/3 A4

(2x)110x178x32mm

BR021



Business Card

BxHxL/LxHxP 93x50x18mm

BR006



Andere modellen op aanvraag.  
Autres modèles sur demande.

# BROCHURE- EN TAGHOUDERS

# PORTE BROCHURES ET TAGS

Muurmodel

Modèle mural



**A4**  
BxHxD/LxHxP  
330x183x32mm | BR104



**A5**  
BxHxD/LxHxP  
230x132x32mm | BR105



**1/3 A4**  
BxHxD/LxHxP  
230x85x32mm | BR107



**2 x A5**  
BxHxD/LxHxP  
(2x) 160x183x32mm | BR125



**3 x A4**  
BxHxD/LxHxP  
(3x) 230x246x32mm | BR129

TAGS & LABELS



PAGINA 360 - 367 - PAGE 360 - 367

Tafel- of muurmodel

Modèle table ou mural



**1/3 A4**  
BxHxD/LxHxP  
110x147x32mm | BR101



**A6**  
BxHxD/LxHxP  
160x117x32mm | BR109



**A5**  
BxHxD/LxHxP  
230x132x32mm | BR005



**A5**  
BxHxD/LxHxP  
160x188x32mm | BR102



**A4**  
BxHxD/LxHxP  
330x183x32mm | BR004



**A4**  
BxHxD/LxHxP  
230x247x32mm | BR103



**4 x 1/3 A4**  
BxHxD/LxHxP  
(4x) 110x147x32mm | BR128



**2 x A5**  
BxHxD/LxHxP  
(2x) 160x211x48mm | BR022



**2 x A4**  
BxHxD/LxHxP  
(2x) 230x246x32mm | BR023



**4 x 1/3 A4**  
BxHxD/LxHxP  
(4x) 110x246x32mm | BR033

Buitengebruik

Usage extérieur



**1/3 A4**  
BxHxD/LxHxP  
110x210x32mm | BR211



**A5**  
BxHxD/LxHxP  
160x210x32mm | BR212



**A4**  
BxHxD/LxHxP  
230x350x32mm | BR213

## Palen met afrolbare linten

## Poteaux à sangles



A11=3m  
A71=4m

- Lintbreedte 50mm
- Hoogte 960mm
- Gewicht ±11kg



A15=3m  
A74=4m

- Largeur sangle 50mm
- Hauteur 960mm
- Poids ±11kg



Gepersonaliseerde linten op aanvraag.  
Sangles personnalisées sur demande.



Paal Poteau	Klr.paal Clr.poteau													
A11.1	Alu	A11.101	A11.102	A11.103	A11.104	A11.105	A11.106	A11.107	A11.110	A11.111	A11.112	A11.113	A11.114	A11.115
A11.2	Champagne	A11.201	A11.202	A11.203	A11.204	A11.205	A11.206	A11.207	A11.210	A11.211	A11.212	A11.213	A11.214	A11.215
A11.3	Brons Bronze	A11.301	A11.302	A11.303	A11.304	A11.305	A11.306	A11.307	A11.310	A11.311	A11.312	A11.313	A11.314	A11.315
A11.4	Zwart Noir	A11.401	A11.402	A11.403	A11.404	A11.405	A11.406	A11.407	A11.410	A11.411	A11.412	A11.413	A11.414	A11.415
A11.5	Geel Jaune	A11.501	A11.502	A11.503	A11.504	A11.505	A11.506	A11.507	A11.510	A11.511	A11.512	A11.513	A11.514	A11.515
A11.6	Blauw Bleu	A11.601	A11.602	A11.603	A11.604	A11.605	A11.606	A11.607	A11.610	A11.611	A11.612	A11.613	A11.614	A11.615
A11.7	Wit Blanc	A11.701	A11.702	A11.703	A11.704	A11.705	A11.706	A11.707	A11.710	A11.711	A11.712	A11.713	A11.714	A11.715
A11.8	Rood Rouge	A11.801	A11.802	A11.803	A11.804	A11.805	A11.806	A11.807	A11.810	A11.811	A11.812	A11.813	A11.814	A11.815
A71.1	Alu	A71.101	A71.102	A71.103	A71.104	A71.105	A71.106	A71.107	A71.110	A71.111	A71.112	A71.113	A71.114	A71.115
A71.2	Champagne	A71.201	A71.202	A71.203	A71.204	A71.205	A71.206	A71.207	A71.210	A71.211	A71.212	A71.213	A71.214	A71.215
A71.3	Brons Bronze	A71.301	A71.302	A71.303	A71.304	A71.305	A71.306	A71.307	A71.310	A71.311	A71.312	A71.313	A71.314	A71.315
A71.4	Zwart Noir	A71.401	A71.402	A71.403	A71.404	A71.405	A71.406	A71.407	A71.410	A71.411	A71.412	A71.413	A71.414	A71.415
A71.5	Geel Jaune	A71.501	A71.502	A71.503	A71.504	A71.505	A71.506	A71.507	A71.510	A71.511	A71.512	A71.513	A71.514	A71.515
A71.6	Blauw Bleu	A71.601	A71.602	A71.603	A71.604	A71.605	A71.606	A71.607	A71.610	A71.611	A71.612	A71.613	A71.614	A71.615
A71.7	Wit Blanc	A71.701	A71.702	A71.703	A71.704	A71.705	A71.706	A71.707	A71.710	A71.711	A71.712	A71.713	A71.714	A71.715
A71.8	Rood Rouge	A71.801	A71.802	A71.803	A71.804	A71.805	A71.806	A71.807	A71.810	A71.811	A71.812	A71.813	A71.814	A71.815
A15.8	Gechrom. Chromé	A15.801	A15.802	A15.803	A15.804	A15.805	A15.806	A15.807	A15.810	A15.811	A15.812	A15.813	A15.814	A15.815
A74.8	Gechrom. Chromé	A74.801	A74.802	A74.803	A74.804	A74.805	A74.806	A74.807	A74.810	A74.811	A74.812	A74.813	A74.814	A74.815



Elke paal heeft  
een kop met  
1 lint en 3  
inhaakpunten.



Chaque poteau a  
une tête avec une  
sangle et 3 points  
d'accrochage.



Verbindingsstuk tussen 2 linten  
Pièce de liaison entre 2 sangles

Zwart  
Noir  
77x25x20mm A43.394S

## Palen met afrolbare linten

## Poteaux à sangles



A12=3m  
A72=4m

- Lintbreedte 50mm
- Hoogte 940mm
- Diam. sokkel: 155mm te vijzen

- Largeur sangle 50mm
- Hauteur 940mm
- Diam. socle: 155mm à visser



A13=3m  
A73=4m

- Lintbreedte 50mm
- Hoogte 985mm
- Diam. sokkel: 330mm te vullen

- Gewicht sokkel: Ledig 1,17kg  
Gevuld 13kg
- Largeur sangle 50mm
- Hauteur 985mm
- Diam. socle: 330mm à lester
- Poids socle: Vide 1,17kg  
Lesté 13kg



Paal Poteau	Klr.paal Clr.poteau													
A12.1	Alu	A12.101	A12.102	A12.103	A12.104	A12.105	A12.106	A12.107	A12.110	A12.111	A12.112	A12.113	A12.114	A12.115
A12.2	Champagne	A12.201	A12.202	A12.203	A12.204	A12.205	A12.206	A12.207	A12.210	A12.211	A12.212	A12.213	A12.214	A12.215
A12.3	Brons Bronze	A12.301	A12.302	A12.303	A12.304	A12.305	A12.306	A12.307	A12.310	A12.311	A12.312	A12.313	A12.314	A12.315
A12.4	Zwart Noir	A12.401	A12.402	A12.403	A12.404	A12.405	A12.406	A12.407	A12.410	A12.411	A12.412	A12.413	A12.414	A12.415
A12.5	Geel Jaune	A12.501	A12.502	A12.503	A12.504	A12.505	A12.506	A12.507	A12.510	A12.511	A12.512	A12.513	A12.514	A12.515
A12.6	Blauw Bleu	A12.601	A12.602	A12.603	A12.604	A12.605	A12.606	A12.607	A12.610	A12.611	A12.612	A12.613	A12.614	A12.615
A12.7	Wit Blanc	A12.701	A12.702	A12.703	A12.704	A12.705	A12.706	A12.707	A12.710	A12.711	A12.712	A12.713	A12.714	A12.715
A12.8	Rood Rouge	A12.801	A12.802	A12.803	A12.804	A12.805	A12.806	A12.807	A12.810	A12.811	A12.812	A12.813	A12.814	A12.815
A72.1	Alu	A72.101	A72.102	A72.103	A72.104	A72.105	A72.106	A72.107	A72.110	A72.111	A72.112	A72.113	A72.114	A72.115
A72.2	Champagne	A72.201	A72.202	A72.203	A72.204	A72.205	A72.206	A72.207	A72.210	A72.211	A72.212	A72.213	A72.214	A72.215
A72.3	Brons Bronze	A72.301	A72.302	A72.303	A72.304	A72.305	A72.306	A72.307	A72.310	A72.311	A72.312	A72.313	A72.314	A72.315
A72.4	Zwart Noir	A72.401	A72.402	A72.403	A72.404	A72.405	A72.406	A72.407	A72.410	A72.411	A72.412	A72.413	A72.414	A72.415
A72.5	Geel Jaune	A72.501	A72.502	A72.503	A72.504	A72.505	A72.506	A72.507	A72.510	A72.511	A72.512	A72.513	A72.514	A72.515
A72.6	Blauw Bleu	A72.601	A72.602	A72.603	A72.604	A72.605	A72.606	A72.607	A72.610	A72.611	A72.612	A72.613	A72.614	A72.615
A72.7	Wit Blanc	A72.701	A72.702	A72.703	A72.704	A72.705	A72.706	A72.707	A72.710	A72.711	A72.712	A72.713	A72.714	A72.715
A72.8	Rood Rouge	A72.801	A72.802	A72.803	A72.804	A72.805	A72.806	A72.807	A72.810	A72.811	A72.812	A72.813	A72.814	A72.815
A13.5	Gl/Zw Jne/Noir			A13.503			A13.506	A13.507						
A13.9	Rd/Wit Rge/Blanc	A13.901	A13.902		A13.904	A13.905								
A73.5	Gl/Zw Jne/Noir			A73.503			A73.506	A73.507						
A73.9	Rd/Wit Rge/Blanc	A73.901	A73.902		A73.904	A73.905								



## Palen met afrolbare linten

## Poteaux à sangles



- Paal in PVC
- Lintbreedte 50mm
- Hoogte 950mm
- Diam. sokkel 360mm
- Gewicht gevuld 9kg
- Poteau en PVC
- Largeur sangle 50mm
- Hauteur 950mm
- Diam. socle 360mm
- Poids lesté 9kg



Paal Poteau	Klr. paal Clr. poteau		
A25.9	Rood/Wit Rouge/Blanc	A25.901	
A25.9	Geel/Zwart Jaune/Noir		A25.902
A27.9	Rood/Wit Rouge/Blanc	A27.901	
A27.9	Geel/Zwart Jaune/Noir		A27.902

## Palen met dubbele afrolbare linten

## Poteaux à sangles doubles



A143.110      A147.810      A155.110      A151.901











- Lintlengte: 3m
- Dubbel lint - Breedte: 50mm en 100mm
- Longueur sangle: 3m
- Double-têtes - Largeur: 50mm et 100mm

Klr. paal Clr. poteau		
Alu	A143.110	
Chrome	A147.810	
Alu	A155.110	
Rood/Rouge		A151.901

## Afrolbare linten

## Sangles



Te vijzen A visser											
50mmx3m	A25.001	A25.002	A25.003	A25.004	A25.005	A25.006	A25.007	A25.042S	A25.059S	A25.066S	A25.523S
50mmx4m	A61.001	A61.002	A61.003	A61.004	A61.005	A61.006	A61.007	A61.042S	A61.059S	A61.066S	A61.523S
Magneet Magnétique											
50mmx3m	A60.001	A60.002	A60.003	A60.004	A60.005	A60.006	A60.007	A60.042S	A60.059S	A60.066S	A60.523S
50mmx4m	A62.001	A62.002	A62.003	A62.004	A62.005	A62.006	A62.007	A62.042S	A62.059S	A62.066S	A62.523S



Plaat te vijzen  
Plaque à visser

A400



Plaat magnetisch  
Plaque magnétique

A700



Verbindingsstuk  
Pièce de liaison

77x25x20mm

A43.394S



- Grijs of zwarte behuizing
- Lintbreedte 50mm
- Te vijzen of magnetisch
- Diverse inhaakmogelijkheden
- Boîtier couleur noir ou gris
- Largeur sangle 50mm
- A visser ou magnétique
- Options d'accrochement divers



Lint Sangle	Rood/Wit Rouge/Blanc		Geel/Zwart Jaune/Noir		Geel Fluo Jaune Fluo		Rood Rouge	
12m-Te vijzen / A visser	A6M001	A6M101	A6M006	A6M106	A6M008	A6M108	A6M002	A6M102
22m-Te vijzen / A visser	A6N001	A6N101	A6N006	A6N106	A6N008	A6N108		
10m-Magnetisch / Magnétique	A6P001*	A6P101*	A6P006*	A6P106*	A6P008*	A6P108*	A6P002*	A6P102*
20m-Magnetisch / Magnétique	A6R001*	A6R101*	A6R006*	A6R106*	A6R008*	A6R108*		

\* Bevestiging A6T0 reeds inbegrepen - Fixation A6T0 incluse



Gepersonaliseerde linten op aanvraag  
Sangles personnalisées sur demande

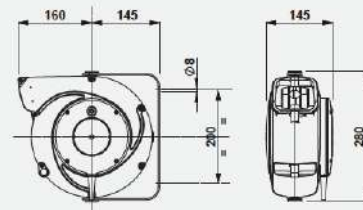
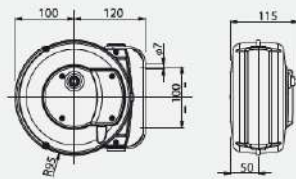

- Haspels voor lange afbakeningen
- Stevige behuizing en beugel
- Linten van 8m of 16m lengte

- Dérouleurs pour délimitations longues
- Boîtier et support robuste
- Sangles de 8m ou 16m

	Rood/Wit Rouge/Blanc	Zwart/Geel Noir/Jaune
8m	A6A001	A6A002
16m	A6B001	A6B002

# AFBAKENING

## Kegeladapters met afrolbare linten



- Lintbreedte 50mm
- Adapter voorzien van 2 haken voor ketting, lampen,...
- Voor kegels van 75 of 100cm
- Kegel niet inbegrepen
- Largeur sangle 50mm
- Adaptateur prévu de 2 crochets pour chaîne, lampes,...
- Pour cônes de 75 ou 100cm
- Cône non-inclus

Adapter Adaptateur	Lengte Longueur				
A190	3m	A19001	A19002	A19A16	A19A17
A191	4m	A19101	A19102		
A19A	3m				



Reflecterend klasse I  
Rétro réfléchissant classe I

75cm	K0075A
100cm	K0100

## Infopalen



- 900mm hoogte
- Diam. sokkel 330mm - te vullen
- Sokkel: ledig 1,17kg - gevuld 13kg
- Picto diam. 300mm - naar keuze
- Hauteur 900mm
- Diam. socle 330mm - à lester
- Socle: vide 1,17kg - lesté 13kg
- Picto diam. 300mm - à choisir

A88.001	Rood/Wit Rouge/Blanc	+REF.Picto 300mm
A88.002	Geel/Zwart Jaune/Noir	+REF.Picto 300mm



Mogelijkheid om te combineren met andere picto's.  
A combiner avec d'autres pictogrammes.



PP  
3223.23



PP  
3223.24



PP  
3223.09



PP  
3223.40



PP  
3423.15



PP  
3223.07

- Met kader - landscape of portret
- 1200mm hoogte - Diam. 60mm
- Gewicht 13kg
- Binnengebruik
- Avec cadre - paysage ou portrait
- Hauteur 1200mm - Diam. 60mm
- Poids 13kg
- Usage intérieur

A4	A7A001
A3	A7B001



## Infopalen

## Poteaux info

Standaard of liggend: te vermelden op uw bestelling  
 Paysage ou portrait: à mentionner dans la commande

- Kader in aluminium
- 1200mm hoogte - Diam. 60mm
- Gewicht ±14kg
- Buitengebruik
- Cadre en aluminium
- Hauteur 1200mm - Diam. 60mm
- Poids ±14kg
- Usage extérieur

Kader / Cadre		Paal met voet en beugel Poteau avec pied et bride
A4	CLIC121	A7C.001
A3	CLIC122	A7D.001



- Formaat A4
- Kader in kunststof landscape of portret
- 1200mm hoogte - Diam. 60mm
- Gewicht 13kg
- Binnengebruik
- Format A4
- Cadre en matière synthétique paysage ou portrait
- Hauteur 1200mm - Diam. 60mm
- Poids 13kg
- Usage intérieur

Grijs / Gris	Champagne	Wit / Blanc
A2A.205S	A2A.212S	A2A.229S
A29.205S	A29.212S	A29.229S

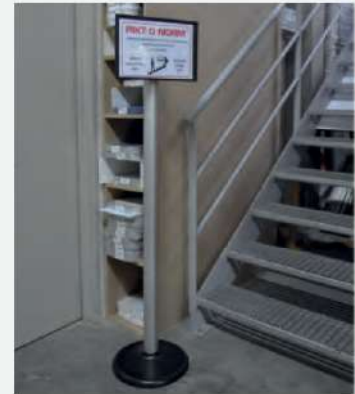

- Formaat A4
- Brochurehouder in plexi
- 880mm hoogte - Diam. 60mm
- Gewicht 13kg
- Binnengebruik
- Format A4
- Présentoir en plexi
- Hauteur 880mm - Diam. 60mm
- Poids 13kg
- Usage intérieur

Grijs / Gris	Champagne	Wit / Blanc
A2B.137S	A2B.144S	A2B.151S
A26.137S	A26.144S	A26.151S

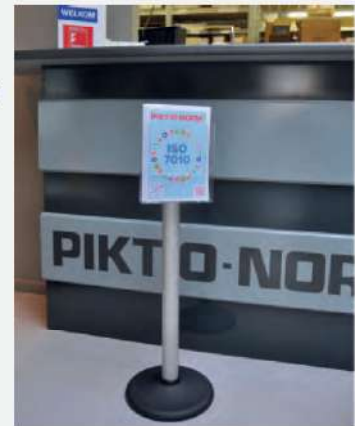

Palen **niet** inbegrepen - Poteaux **non** inclus  
 Verbindingschakel **inbegrepen** - Collier de liaison **inclus**



Infokader A4 Support info A4	Infokader A4 Support info A4	Infokader A3 Support info A3	Brochurehouder A4 Présentoir A4	Verbindingsschakel Collier de liaison
A32.236S	A79.001	A78.001	A34.168S	A80.001

## Palen voor koorden of kettingen

## Poteaux pour cordons ou chaînes

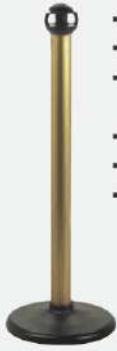

- 940mm hoogte
- Diam. sokkel 325mm
- Gewicht 11,4kg
- Hauteur 940mm
- Diam. socle 325mm
- Poids 11,4kg

A20



- 910mm hoogte
- Diam. sokkel 155mm te vijzen
- Gewicht 1,6kg
- Hauteur 910mm
- Diam. socle 155mm a visser
- Poids 1,6kg

A21



- 970mm hoogte
- Diam. sokkel 330mm te vullen
- Gewicht sokkel: Ledig: 1,17kg, Gevuld: 13kg
- Hauteur 970mm
- Diam. socle 330mm a lester
- Poids socle: Vide: 1,17kg, Lesté: 13kg

A22



Zorg voor een vrije of vergrendelde positie door een draai aan de knop.  
Fonction de verrouillage par simple pivotement de la tête.

Kleur paal Couleur poteau	Alu Alu	Champagne Champagne	Bronz Bronze	Zwart Noir	Rood Rouge	Geel Jaune	Blauw Bleu	Wit Blanc
A20	A20.008S	A20.015S	A20.022S	A20.039S	A20.046S	A20.053S	A20.190S	A20.060S
A21	A21.084S	A21.091S	A21.107S	A21.114S	A21.121S	A21.138S	A21.237S	A21.145S
A22					A22.01	A22.02		



Koord - 26mm diam.  
Cordon - Diam. 26mm

	Grijs Gris	Zwart Noir	Bordeaux
1,5m	A44.052S	A44.045S	A44.038S
2m	A46.021S	A46.014S	A46.007S

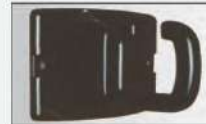

Muurplaat met haak voor koord  
Platine murale avec anneau ouvert pour cordon

	Rood Rouge	Zwart Noir	Wit Blanc
	A42.740S	A42.757S	A42.764S



- Volledig verchromd
- 900mm hoogte
- Diam. sokkel 335mm
- Gewicht 9,8kg
- Totalement chromé
- Hauteur 900mm
- Diam. socle 335mm
- Poids 9,8kg

A530



- Volledig verchromd
- 930mm hoogte
- Diam. sokkel 335mm
- Gewicht 9,8kg
- Totalement chromé
- Hauteur 930mm
- Diam. socle 335mm
- Poids 9,8kg

A540



Muurplaat  
Platine murale

A550



Musketon koorden - Verchromde musketon - Diam. 30mm  
Cordes à mousqueton - Mousqueton chromé - Diam. 30mm

	Zwart Noir	Blauw Bleu	Bordeaux	Grijs Gris
2m	A56.9001	A56.9161	A56.9011	A56.9021

## Metalen palen voor koorden of kettingen Poteaux métalliques pour cordons ou chaînes



- 800mm hoogte
- Diam. 50mm
- Gewicht 2,9kg

- Hauteur 800mm
- Diam. 50mm
- Poids 2,9kg

Assortiment kettingen raadpleegbaar op pagina 220  
Assortiment chaînes à consulter page 220



Wit Blanc	Rood/Wit Rouge/Blanc	Geel/Zwart Jaune/Noir
A229.01	A229.03	A229.04



	Rood/Wit Rouge/Blanc	Geel/Zwart Jaune/Noir
Paal 1m Poteau 1m	K91R	K91Z
Paal 1,15m Poteau 1,15m	K95R	K95Z



Afdekdop  
Calotte  
K971



Inbouwhuls  
Douille à encastrer  
K970



Vlakke voet  
Pied plat  
K940 K941

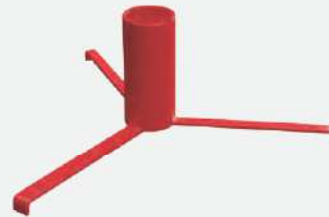

Driepoot 500mm  
Trépied 500mm  
K93R K93Z



- 1000mm hoogte
- Diam. 51mm
- Voetplaat 150x150mm te vijzen
- Hauteur 1000mm
- Diam. 51mm
- Pied 150x150mm à viser

Rood/Wit  
Rouge/Blanc  
K98R



- 1025mm hoogte
- Diam. 51mm
- Voetplaat 250x250mm verplaatsbaar
- Hauteur 1025mm
- Diam. 51mm
- Pied 250x250mm amovible

Rood/Wit  
Rouge/Blanc  
K99R



K99R

## Palen voor kettingen

## Poteaux pour chaînes



- 960mm hoogte
- Diam. sokkel 230mm
- Hoogte sokkel 100mm
- Gewicht 7kg
- Hauteur 960mm
- Diam. socle 230mm
- Hauteur socle 100mm
- Poids 7kg

Rood/Wit  
Rouge/Blanc  
K9AR

Geel/Zwart  
Jaune/Noir  
K9AG

Paal voorzien van een kern uit aluminium  
Poteau avec un intérieur en aluminium



## Palen

## Poteaux

DELIMITATION



Sokkel / Socle 4kg



Sokkel / Socle 9kg

- Paal in PVC
- 900mm hoogte
- Diam. 50mm
- Sokkel te vullen 4 of 9kg

- Poteau en PVC
- Hauteur 900mm
- Diam. 50mm
- Socle à lester 4 ou 9kg



	Wit Blanc	Zwart Noir	Rood/Wit Rouge/Blanc	Geel/Zwart Jaune/Noir	Bronsgroen Vert bronze
4kg / 280x280mm	A221.01	A221.02	A221.03	A221.04	A221.05
9kg / Diam.360mm	A222.01	A222.02	A222.03	A222.04	A222.05



	Rood/Wit Rouge/Blanc	Geel/Zwart Jaune/Noir	Wit Blanc	Zwart Noir
4kg / 280x280mm	A22A.03	A22A.04	A22A.01	A22A.02



- Paal in PVC
- 900mm hoogte
- Diam. 50mm
- Opplooibaar systeem
- Gewicht 4kg

- Poteau en PVC
- Hauteur 900mm
- Diam. 50mm
- Système pliable
- Poids 4kg

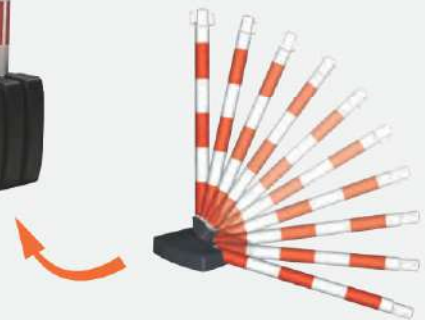

Plaatsbesparend, met blokkage systeem  
Gain de place, avec système de blocage



Rood/Wit  
Rouge/Blanc  
K80R

Geel/Zwart  
Jaune/Noir  
K80Z

- Paal in PVC
- 910mm hoogte
- Diam. 51mm
- Gewicht 0,4kg

- Poteau en PVC
- Hauteur 910mm
- Diam. 51mm
- Poids 0,4kg



Gerecycleerd kunststof  
Matière synthétique recyclé  
sokkel/socle 3kg K830



Paal en voet afzonderlijk te bestellen.  
Poteau et pied à commander séparément.



AFBAKENING



- 900mm hoogte
- Diam. 50mm
- Met punt om in de grond te duwen

- Hauteur 900mm
- Diam. 50mm
- Avec pointe pour enfoncer dans le sol



Wit Blanc	Rood/Wit Rouge/Blanc	Geel/Zwart Jaune/Noir	Bronsgroen Vert bronze
A223.01	A223.03	A223.04	A223.05

## Kegeladapters voor ketting

## Adaptateurs cônes pour chaînes



- Voorzien van 2 haken voor ketting
- Voor kegel K0050D
- Kegel niet inbegrepen

- Prévu de 2 crochets pour chaîne
- Pour cône K0050D
- Cône non-inclus



K2111



Reflecterend klasse I  
Rétro réfléchissant classe I

PVC

50cm K0050D

## Ketting

## Chaînes



Verbindingsschakel  
Connecteur

K2110



Universele verbindingsschakel  
Connecteur universel

K2010

Polyethyleen / Polyéthylène Diam. 6mm	per lopende meter par mètre courant	Polyethyleen / Polyéthylène Diam. 6mm	per 25 meter par 25 mètre	Polyethyleen / Polyéthylène Diam. 8mm	per 25 meter par 25 mètre	Staal / Acier Diam. 6mm	per 10 meter par 10 mètre
Rood/Wit Rouge/Blanc	K2001	Wit Blanc	K2003	Rood/Wit Rouge/Blanc	K2281	Rood/Wit Rouge/Blanc	K2101
Geel/Zwart Jaune/Noir	K2002	Groen/Wit Vert/Blanc	K2004	Geel/Zwart Jaune/Noir	K2282	Geel/Zwart Jaune/Noir	K2102
Fotolum/Rood Photolum/Rouge	SG5000	Zwart Noir	K2006				
Fotolum Photolum	SG5005	Geel Jaune	K2007				
Fotolum/Zwart Photolum/Noir	SG5010	Rood Rouge	K2008				
		Groen Vert	K2009				
		Rood/Wit Rouge/Blanc	K2201*	*per 30 meter *par 30 mètre			
		Geel/Zwart Jaune/Noir	K2202				



- Kettingbarrière
- Voorzien van verticale kettingstukken
- Diam. 6mm
- Barrière de chaîne
- Prévue de morceaux de chaîne verticales
- Diam. 6mm

	Rood/Wit Rouge/Blanc	Geel/Zwart Jaune/Noir
5m	K2301	K2302
10m	K2311	K2312
17,5m	K2321	K2322
25m	K2331	K2332

## Telescopische barrières

## Barrières télescopiques



- PVC uitvoering
- Reflecterend klasse I recto/verso
- 150mm hoogte

- Réalisée en PVC
- Rétroréfléchissant classe I recto/verso
- Hauteur 150mm



Koppelstuk voor kegel K0050D  
Adaptateur pour cône K0050D

K2111



1-1,8m	K3001	K3003	K3002	K3004
2-3,8m	K3011	K3013	K3012	K3014



## Bakens

## Balises



- Kunststof
- 840mm hoogte
- Diam. 105mm
- Reflecterende strip 440mm
- Te vijzen

- Matière synthétique
- Hauteur 840mm
- Diam. 105mm
- Strip rétro réfléchissante 440mm
- A visser

Paal/Poteau K840  
Voet/Pied K84A



- Kunststof
- 750mm hoogte
- Diam. 100mm
- 2 reflecterende strips
- Met elastiek
- Te vijzen

- Matière synthétique
- Hauteur 750mm
- Diam. 100mm
- 2 strips rétro réfléchissants
- Avec élastique
- A visser

Paal en voet  
Poteau et pied K8C0



- Kunststof baken
- 750mm hoogte
- Diam. 200mm
- 2 reflecterende strips klasse II
- Intern te bevestigen met sleutel

- Balise synthétique
- Hauteur 750mm
- Diam. 200mm
- 2 strips rétro réfléchissants classe II
- A fixer à l'intérieur avec clé

Geel/Jaune	K8D02
Rood/Rouge	K8D01
Groen/Vert	K8D03
Bevestigingshuls/Ancre cosse	K8E0
Stang/sleutel/Clé barre	K8F0



Stang/sleutel  
Clé barre



- Gerecycleerd kunststof
- 150x150mm vierkant
- 2 reflectiebanden 18mm - rood/wit
- Los of met grondverankering

- Plastique recyclé
- 150x150mm carré
- 2 bandes réfléchissantes -18mm rouge/blanc
- Non fixé ou avec ancrage sol



Losse paal  
Poteau détaché



Grondverankering + Paal + Sleutel  
Ancrage sol + Poteau + Clé



Vervangpaal  
Poteau de remplacement

Zwart / Noir		Bruin / Brun		Zwart / Noir		Bruin / Brun		Zwart / Noir		Bruin / Brun	
1400mm-14,5kg	K850	K860		1320mm-14,5kg	K870	K880		800mm-11,5kg	K89Z	K89B	

- Parat
- 1000mm hoogte
- Wegneembaar
- Driehoeksslot
- Grondkoker

- Parat
- Hauteur 1000mm
- Rétractable
- Serrure à clé triangulaire
- Douille à ancrer



	Rood/Wit Rouge/Blanc	Galva
70x70mm	K921	K923
76mm	K922	



Driehoekssleutel  
Serrure à clé triangulaire

K972



**AFBAKENING**

- Sesam
- 1000mm hoogte
- Neerklapbaar
- Driehoekslot of cilinder
- Grondkoker of bodemplaat



- Sesam
- Hauteur 1000mm
- Escamotable
- Serrure à clé triangulaire ou cylindre
- Douille à ancrer ou platine

GRONDKOKER DOUILLE A ANCRER	Rood/Wit Rouge/Blanc
70x70mm Cilinderslot / Serrure cylindre	K961
70x70mm Driehoekslot / Serrure à clé triangulaire	K965

BODEMPLAAT PLATINE	Rood/Wit Rouge/Blanc
70x70mm Cilinderslot / Serrure cylindre	K963
70x70mm Driehoekslot / Serrure à clé triangulaire	K967



**Driehoekssleutel  
Serrure à clé triangulaire**

K972



## Skipper

## Skipper



Oranje houder 145x145x240 mm	SKIPPER0101	SKIPPER0102	SKIPPER0103	SKIPPER0104	SKIPPER0105	SKIPPER0106
Groene houder 145x145x240 mm	SKIPPER0107	SKIPPER0108	SKIPPER0109	SKIPPER0110	SKIPPER0111	SKIPPER0112
Rode houder 145x145x240 mm	SKIPPER0113	SKIPPER0114	SKIPPER0115	SKIPPER0116	SKIPPER0117	SKIPPER0118
Blauwe houder 145x145x240 mm	SKIPPER0119	SKIPPER0120	SKIPPER0121	SKIPPER0122	SKIPPER0123	SKIPPER0124
Zilver houder 145x145x240 mm	SKIPPER0125	SKIPPER0126	SKIPPER0127	SKIPPER0128	SKIPPER0129	SKIPPER0130
Gele houder 145x145x240 mm	SKIPPER0131	SKIPPER0132	SKIPPER0133	SKIPPER0134	SKIPPER0135	SKIPPER0136

- Spoel met vergrendelknop
- Bevat 9m stoffen lint, hoge zichtbaarheid
- Robuuste materialen voor zwaar gebruik

- Bobine avec bouton de verrouillage
- Contient 9m de ruban rétractable en tissu haute visibilité
- Matériaux robustes et résistants



SKIPPER0201 SKIPPER0202 SKIPPER0203 SKIPPER0204 SKIPPER0205 SKIPPER0206

- Elke paal wordt geleverd met 2x reflecterende, hoge zichtbaarheid strips
- Voet opvulbaar met water of zand voor extra stabiliteit
- Compatibel met Skipper afrolbaar lint

- Chaque poteau est équipé de 2 bandes réfléchissantes à haute visibilité.
- Lestez le socle avec de l'eau ou du sable pour une meilleure stabilité.
- Compatible avec dérouleur Skipper



Voet - Socle (leeg/vidu)  
zwart/noir - 500x500x125mm

SKIPPER0207



SKIPPER0211 SKIPPER0212 SKIPPER0213 SKIPPER0214 SKIPPER0215 SKIPPER0216

- Compatibel met Skipper paal of kegel

- Compatibele avec poteau ou cône Skipper



SKIPPER0301

- Retroreflecterend / Retroréfléchissant
- 5,43 kg



Skipper affichehouder A4  
Skipper support affiche A4  
SKIPPER0406

- Ook geschikt voor gebruik buiten
- Compatibel met Skipper linthouder
- Adapté pour l'extérieur
- Compatible avec derouleur Skipper



Afmetingen/Dimensions: 266mmx348mmx28mm  
Gewicht/Poids: 480g



Skipper muurhouder magneet  
Skipper support magnétique  
SKIPPER0401



Afmetingen/Dimensions: 124mmx168mmx133mm  
Gewicht/Poids: 275g



Skipper ontvanger magneet  
Skipper récepteur magnétique  
SKIPPER0403



Afmetingen/Dimensions: 80mmx100mmx23mm  
Gewicht/Poids: 60g



Skipper muurhouder te vijzen  
Skipper support à viser  
SKIPPER0402



Afmetingen/Dimensions: 124x168x130mm  
Gewicht/Poids: 170g



Skipper ontvanger te vijzen  
Skipper récepteur à viser  
SKIPPER0404



Afmetingen/Dimensions: 80mmx100mmx23mm  
Gewicht/Poids: 45g

# AFBAKENING

# DELIMITATION



herlaadbaar - excl. batterijen  
rechargeable - piles non-inclus

Skipper LED lamp  
Skipper lampe LED  
SKIPPER0405

- Inclusief lichtsensor voor automatische activering bij weinig licht (kan worden uitgeschakeld)
- Permanent of knipperend met Amerikaanse, Europese en Britse flitsfrequenties
- Oplaadbaar
- Comprend un capteur de lumière pour l'activation automatique en cas de faible lumière (peut être désactivé)
- Installation permanente ou clignotante avec des taux de clignotement américains, européens et du Royaume-Uni
- Rechargeable



Afmetingen/Dimensions: 140x122x140mm  
Gewicht/Poids: 360g



Dummy - 145x145x240mm

SKIPPER0137

SKIPPER0138

SKIPPER0139

SKIPPER0140

SKIPPER0141

SKIPPER0142

- Een Skipper unit zonder lint, kan worden gebruikt om een afbakening te beëindigen
- Une unité Skipper sans ruban, peut être utilisée pour terminer une délimitation

# PARKEERBEUGELS

# BARRIERES DE PARKING



- 900x600x60mm-9kg
- Cilinderslot, 2 sleutels
- Centrale steun
- Bevestigingen inbegrepen
- 900x600x60mm-9kg
- Serrure cylindre, 2 clés
- 1 pied central
- Fixations incluses



- 755x400x360mm-5,2kg
- Systeem met hangslot
- Slot inbegrepen
- Bevestigingen inbegrepen
- 755x400x360mm-5,2kg
- Système cadenas
- Cadenas inclus
- Fixations incluses

Afzonderlijk sluitend / Fermeture individuelle K3A01  
 Gelijksluitend / Fermeture identique K3A02

K3B01



- 980x450x400mm-12kg
- Cilinderslot, 3 sleutels
- Automatische sluitvergrendeling
- Bevestigingen inbegrepen
- 980x450x400mm-12kg
- Serrure cylindre, 3 clés
- Verrouillage fermeture automatique
- Fixations incluses



- 1050x450x400mm-13kg
- Cilinderslot, 3 sleutels
- Automatische sluitvergrendeling
- Met rubberen schokabsorbers
- Bevestigingen inbegrepen
- 1050x450x400mm-13kg
- Serrure cylindre, 3 clés
- Verrouillage fermeture automatique
- Avec amortisseurs en caoutchouc
- Fixations incluses

Afzonderlijk sluitend / Fermeture individuelle K3C01  
 Gelijksluitend / Fermeture identique K3C02

K3D01  
 K3D02



- 50x600x50mm-5,5kg
- Cilinderslot met 3 sleutels
- Bevestigingen inbegrepen
- 50x600x50mm-5,5kg
- Serrure cylindre 3 clés
- Fixations incluses



- 710x520x40mm
- Cilinderslot, 2 sleutels
- Bevestigingen niet inbegrepen
- 710x520x40mm
- Serrure cylindre, 2 clés
- Fixations non-incluses

Afzonderlijk sluitend / Fermeture individuelle K3F01  
 Gelijksluitend / Fermeture identique K3F02

Zonder nummerplaat / Sans plaque K3804  
 Met nummerplaat / Avec plaque (Ref. 520x110mm) K3805MT

## Nummerplaten

## Plaques d'immatriculation

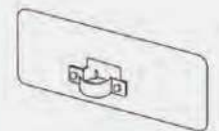

Alu plaat met beugel 5mm - niet reflecterend  
 Plaque alu avec bride 5mm - non réfléchissant

	Blanco	VIN.	VIN.REFL.	PP	PP REFL.	ALU	ALU REFL.
	340x110	9132.00	9132.RE	9122.00	9122.RE	9112.00	9112.RE
	520x110	9232.00	9232.RE	9222.00	9222.RE	9212.00	9212.RE
Met tekst / Avec texte							
	340x110	9132.MT	9132R.MT	9122.MT	9122R.MT	9112.MT	9112R.MT
	520x110	9232.MT	9232R.MT	9222.MT	9222R.MT	9212.MT	9212R.MT

	Blanco
	340x110 9119.01
	520x110 9118.01
Met tekst / Avec texte	
	340x110 9119.MT
	520x110 9118.MT









































# PARKINGSIGNALISATIE

Aluminium Type 2000 - Retroflecterend klasse I

# SIGNALISATION PARKING

Aluminium Type 2000 - Rétro réfléchissant Classe I

SIGNALISATION PARKING

						
400x200 K644.01	K644.02	K644.03	K644.04	K644.05	K644.06	K644.07
						
400x200 K644.08	K644.09	K644.10	K644.11	K644.12	K644.13	K644.14
						
400x200 K644.15	K644.16	K644.17	K644.18	K644.19	K644.20	K644.21
						
400x200 K644.22	K644.23	K644.24	K644.25	K644.26	K644.27	K644.28
						
400x200 K644.29	K644.30	K644.31	K644.32	K644.33	K644.34	K644.35
						
400x200 K644.36	K644.37	K644.50	K64A.MT			



Aluminium Type 2000 - Retroflecterend klasse I

Aluminium Type 2000 - Rétro réfléchissant Classe I

						
400x400 K645.26	K645.27	K645.28	K645.29	K645.30	K645.31	K645.32
						
400x400 K645.33	K645.34	K645.35	K645.36	K645.37	K64B.MT	

PARKINGSIGNALISATIE

Retroflecterend klasse I

Rétro réfléchissant Classe I



400x600

T2000	K646.E9a	K646.E9b	K646.E9c	K646.E9d	K646.E9e	K646.E9f
Dibond 3mm	K647.E9a	K647.E9b	K647.E9c	K647.E9d	K647.E9e	K647.E9f



400x600

T2000	K646.E9g	K646.E9h	K646.E9i	K646.41	K646.42	K646.39
Dibond 3mm	K647.E9g	K647.E9h	K647.E9i	K647.41	K647.42	K647.39



400x600

T2000	K646.F59	K646.40	K646.01	K646.02	K646.03	K646.05
Dibond 3mm	K647.F59	K647.40	K647.01	K647.02	K647.03	K647.05



400x600

T2000	K646.06	K646.07	K646.08	K646.09	K646.10	K646.11
Dibond 3mm	K647.06	K647.07	K647.08	K647.09	K647.10	K647.11



400x600

T2000	K646.12	K646.13	K646.14	K646.15	K646.16	K646.17
Dibond 3mm	K647.12	K647.13	K647.14	K647.15	K647.16	K647.17



400x600

T2000	K646.18	K646.19	K646.20	K646.21	K646.22	K646.23
Dibond 3mm	K647.18	K647.19	K647.20	K647.21	K647.22	K647.23



400x600

T2000	K646.24	K646.25	K646.26	K646.27	K646.28	K646.29
Dibond 3mm	K647.24	K647.25	K647.26	K647.27	K647.28	K647.29

SIGNALISATION PARKING

PARKINGSIGNALISATIE

Retroflecterend klasse I

Rétro réfléchissant Classe I

400x600					
T2000 K646.30	K646.31	K646.32	K646.33	K646.34	K646.35
Dibond 3mm K647.30	K647.31	K647.32	K647.33	K647.34	K647.35
400x600		600x400		400x200	
T2000 K646.36	K646.37	K646.50	K64C.MT	T2000 K6411.LP	
Dibond 3mm K647.36	K647.37	K647.50	K64D.MT	SB250 K5411.LP	
				Alu K4411.LP	
400x600					
T2000 K6415.AL	K6415.FL	K646.43			
Dibond 3mm K647.AL	K647.FL	K647.43			
SB250 K5415.AL					

Dibond 3mm

Dibond 3mm

340x110	340x110	340x110	340x110	340x110	340x110
Nt.refl. / Non réf. 9113.01	9113.02	9113.03	9113.04	9113.05	9113.06
Refl.KIJ / Réf.CIJ 91R3.01	91R3.02	91R3.03	91R3.04	91R3.05	91R3.06
340x110	340x110	340x110	340x110	340x110	340x110
Nt.refl. / Non réf. 9113.07	9113.08	9113.09	9113.10	9113.11	9113.12
Refl.KIJ / Réf.CIJ 91R3.07	91R3.08	91R3.09	91R3.10	91R3.11	91R3.12
340x110	340x110	340x110	340x110	340x110	340x110
Nt.refl. / Non réf. 9113.13	9113.14	9113.15	9113.16	9113.17	9113.18
Refl.KIJ / Réf.CIJ 91R3.13	91R3.14	91R3.15	91R3.16	91R3.17	91R3.18
340x110	340x110	340x110	340x110	340x110	340x110
Nt.refl. / Non réf. 9113.19	9113.20	9113.21	9113.22	9113.23	9113.24
Refl.KIJ / Réf.CIJ 91R3.19	91R3.20	91R3.21	91R3.22	91R3.23	91R3.24
340x110	340x110	340x110	340x110	340x110	340x110
Nt.refl. / Non réf. 9113.25	9113.26	9113.27	9113.28	9113.29	9113.30
Refl.KIJ / Réf.CIJ 91R3.25	91R3.26	91R3.27	91R3.28	91R3.29	91R3.30
340x110	340x110	340x110	340x110	340x110	340x110
Nt.refl. / Non réf. 9113.31	9113.32	9113.33	9113.34	9113.50	9113.MT
Refl.KIJ / Réf.CIJ 91R3.31	91R3.32	91R3.33	91R3.34	91R3.50	91R3.MT

Aluminium Type 2000 - Retroreflecterend Klasse I

Aluminium Type 2000 - Rétro réfléchissant Classe I

**P** Klanten

Clients **P**

**P** Uw tekst

Votre texte **P**

850x200	Pijl rechts / Flèche droite	Pijl links / Flèche gauche
PARKING	K648.01	K648.50
BEZOEKERS	K648.02	K648.51
VISITEURS	K648.03	K648.52
VISITEURS/BEZOEKERS	K648.04	K648.53
KLANTEN	K648.05	K648.54
CLIENTS	K648.06	K648.55
CLIENTS/KLANTEN	K648.07	K648.56
PERSENEEL	K648.08	K648.57
PERSONNEL	K648.09	K648.58
PERSONNEL/PERSENEEL	K648.10	K648.59
LEVERANCIERS	K648.11	K648.60
FOURNISSEURS	K648.12	K648.61
FOURNISSEURS/LEVERANCIERS	K648.13	K648.62
LEVERINGEN	K648.14	K648.63
LIVRAISONS	K648.15	K648.64

850x200	Pijl rechts / Flèche droite	Pijl links / Flèche gauche
UW TEKST / VOTRE TEXTE	K64E.MT	K64F.MT



SIGNALISATION PARKING

## Verboden te stationeren

## Défense de stationner

Retroreflecterend Klasse I

Rétro réfléchissant Classe I

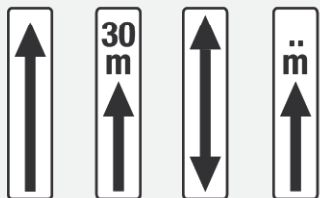

	100x400mm	Xa	Xc	Xd	XMT	400x200mm	400x200mm	400mm
Plat	K4410Xa	K4410Xc	K4410Xd	K4410XMT	K44311	K44312	K4101E3	
Plat met beugel diam. 51mm	K441BXa	K441BXC	K441BXD	K441BXMT	K44321	K44322		
Plat avec bride diam. 51mm								
T2000	K6410Xa	K6410Xc	K6410Xd	K6410XMT	K66011	K66012	K6101E3	
SB250	K5410Xa	K5410Xc	K5410Xd	K5410XMT	K54311	K54312	K7101E3	

### Sets: VERBODEN TE STATIONEREN - DEFENSE DE STATIONNER

### KRIJTSTIFT - MARQUEUR DE CRAIE



Alu plat NL	Type2000 NL	TypeSB250 NL
K3701N	K3702N	K3703N
-Bigfoot -Paal 40/40 1,5m -Krijtbord -Bord E3 Dia40cm -Xa-bord -4beugels K3307	-Bigfoot -Paal 40/40 1,5m -Krijtbord -Bord E3 Dia40cm -Xa-bord -6beugels K3305	-Bigfoot -Paal 40/40 1,5m -Krijtbord -Bord E3 Dia40cm -Xa-bord -3beugels K3306
Alu plat FR	Type2000 FR	TypeSB250 FR
K3701F	K3702F	K3703F
-Bigfoot -Poteau 40/40 1,5m -Panneau craie -Panneau E3 Dia40cm -Panneau-Xa -4brides K3307	-Bigfoot -Poteau 40/40 1,5m -Panneau craie -Panneau E3 Dia40cm -Panneau-Xa -6brides K3305	-Bigfoot -Poteau 40/40 1,5m -Panneau craie -Panneau E3 Dia40cm -Panneau-Xa -3brides K3306



5mm  
Wit / Blanc MARKER KW



56cm - 2,8kg  
Top: polyethyleen  
Voet : gerecycleerde pvc  
Niet-reflecterend

56cm - 2,8kg  
Pointe: polyéthylène  
Pied : pvc recyclé  
Non réfléchissant

K0056

PARKINGSIGNALISATIE

## Palen

## Poteaux

Lengte Longueur	Galva	Galva	Gelakt Peint	Gelakt Peint	Galva	Gelakt Peint
	Diam.51mm	Diam.76mm	Diam.51mm	Diam.76mm	40x40mm	40x40mm
100cm	K3111	K3211		K3221	K3311	K3321
150cm	K3112	K3212	K3122	K3222	K3312	K3322
200cm	K3113	K3213	K3123	K3223	K3313	K3323
250cm	K3114	K3214	K3124	K3224	K3314	K3324
300cm	K3115	K3215	K3125	K3225	K3315	K3325
350cm	K3116	K3216	K3126	K3226		
400cm	K3117	K3217	K3127	K3227		
450cm		K3218		K3228		



Paal met voetplaat  
Poteau avec platine

K3220

- Voetplaat / Platine: 500x500x12mm
- Hoogte / Largeur: 300cm
- Diameter: 76mm

Oranje (RAL2009)  
of grijs (RAL7043)

## Paaldoppen

## Calottes



Diam.	
40mm	K330A
51mm	K3101
76mm	K3201



Atm./Dim.	
40x40mm	K3301

## Voeten

## Pieds

### BIGFOOT



Gewicht / Poids
+/-25kg 780x400x120mm K3500

Voor paal / Pour poteau  
2x Ø43mm - Ø60mm - 40x40mm -  
60x60mm - 40x80mm kruis/croix

### MINIFOOT



Gewicht / Poids
15kg 400x400mm K3505

Voor paal 40x40mm  
Pour poteau 40x40mm

### GERECYCLEERD KUNSTSTOF MAT. SYNTHÉTIQUE RECYCLE



Gewicht / Poids
+/-8kg 270x270x500mm K3502

Voor paal diam. 76mm  
Pour poteau diam. 76mm

### ADAPTER ADAPTATEUR



K3503

Voor paal diam. 51mm  
Pour poteau diam. 51mm

### BETONVOETEN - PIEDS EN BETON



Gewicht / Poids	Diam.	
33kg	51mm	K3108
52kg	76mm	K3208

### GEGALVANISEERDE STALEN VOETPLAAT PLATINE EN ACIER GALVANISÉ

4 bevestigingsgaten - Voor paal diam. 51mm  
4 trous de fixation - Pour poteau diam. 51mm



200x200x10mm K3109B



Mogelijkheid tot uitvoeren van uw projecten.  
Possibilité de réaliser vos projets.

## Beugels

## Brides

Voor borden alu plat

Pour panneaux alu plat



Paal / poteau	
40x40mm	K3306
40x60mm	K3308
40x80mm	K3309



Paal / poteau	
40x40mm	K3307

Voor borden Type 2000

Beugels Ø51mm apart te bestellen  
Brides Ø51mm à commander séparément

Pour panneaux Type 2000



Dubbelzijdige beugel  
Bride double face



Muurbevestiging  
Fixation mur



Zijdelingse muuruitkraging  
Fixation en drapeau

Paal / poteau Ø		Paal / poteau Ø		Paal / poteau		Paal / poteau		Borden / panneaux	
51mm	K3104	51mm	K3151	40x40mm	K3305	60x60mm	K3407	○ & □	400mm K3131
76mm	K3204	76mm	K3251					○ & □	700mm K3141
								△	400mm K3132
								△	700mm K3142

Voor borden Type 250

Pour panneaux Type 250



Dubbelzijdige beugel  
Bride double face



Bordenbeugel voor tijdelijke signalisatie  
Bride pour signalisation temporaire



Paal / poteau Ø		Paal / poteau Ø		Paal / poteau		Muurbevestiging / Fixation mur	
51mm	K3105	51mm	K3152	40x40mm	K3306		40x40mm K3110
76mm	K3205	76mm	K3252			K3153	

Rail voor Type 250 beugels of spanning

Rail pour brides Type 250 ou collier



Per meter  
Le mètre

K3102

Voorzien van sterk hechtende VST-tape  
Fourni avec tape à haute adhérence - VST



Buis / Tuyau Ø	
12-22mm	4750
20-32mm	4751
25-40mm	4752
40-60mm	4753
60-80mm	4754
80-100mm	4755
100-120mm	4756
120-140mm	4757
140-160mm	4758
150-170mm	4759
190-210mm	475A

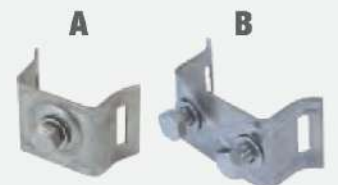

Bandimex montagebeugel RVS  
Support de montage Bandimex en acier inoxydable

met 1 bout / avec 1 boulon M8x16mm	met 2 bouten / avec 2 boulons M8x16mm
B28006A	B28006B

## Borden

## Panneaux

Hoe uw artikelcode samen te stellen

Comment composer votre code d'article.

1. Bepaal de vorm  
1. Déterminez la forme

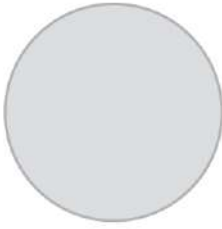

Voorbeeld Cirkel  
Exemple Circle



2. Kies het type  
2. Choisissez le type



Voorbeeld Type 2000  
Exemple Type 2000



3. Selecteer reflectieklasse en formaat  
3. Sélectionnez la classe de réflexion et format



Voorbeeld Retrorefl. KL. I - 700mm: K6102..  
Exemple Rétrorefl. CL. I - 700mm: K6102..

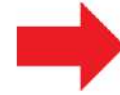

4. Combineer met de bordcode  
4. Combinez avec le code du panneau



Voorbeeld K6102C1  
Exemple K6102C1

Klasse I : 7 jaar garantie Classe I : 7 ans de garantie		Klasse II : High intensity Classe II : High intensity		Klasse III : Diamond grade Classe III : Diamond grade	
<b>Vinyl:</b> Retroreflecterend Kl. I	<b>Plat alu:</b> Retroreflecterend Kl. I	<b>T2000:</b> met alu rand: Retroreflecterend Kl. I - Kl. II - Kl. III	<b>SB250:</b> met dubbele alu rand, uit 1 stuk geperst & bevestigingsrail Retroreflecterend Kl. I - Kl. II - Kl. III		
<b>Vinyle:</b> Rétro réfléchissant Cl. I	<b>Alu plat:</b> Rétro réfléchissant Cl. I	<b>T2000:</b> bord en alu: Rétro réfléchissant Cl. I - Cl. II - Cl. III	<b>SB250:</b> à double bord en alu, pressé en 1 fois & rail de fixation Rétro réfléchissant Cl. I - Cl. II - Cl. III		



	VIN.	Plat Alu Alu Plat	Plat Alu MT* Alu Plat MT*	T2000 Kl.I T2000 Cl.I	T2000 Kl.I MT* T2000 Cl.I MT*	T2000 Kl.II T2000 Cl.II	T2000 Kl.III T2000 Cl.III	SB250 Kl.I SB250 Cl.I	SB250 Kl.II SB250 Cl.II	SB250 Kl.III SB250 Cl.III
400mm	K4A01..	K4101..	K4101MT	K6101..	K6101MT	K6A01..	K6K01..	K7101..	K7A01..	K7K01..
700mm	K4A02..	K4102..	K4102MT	K6102..	K6102MT	K6A02..	K6K02..	K7102..	K7A02..	K7K02..
900mm	K4A03..	K4103..	K4103MT	K6103..	K6103MT	K6A03..	K6K03..	K7103..	K7A03..	K7K03..

\* MT = Met tekst of eigen picto  
\* MT = Avec texte ou propre picto

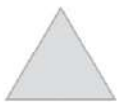

	VIN.	Plat Alu Alu Plat	Plat Alu MT* Alu Plat MT*	T2000 Kl.I T2000 Cl.I	T2000 Kl.I MT* T2000 Cl.I MT*	T2000 Kl.II T2000 Cl.II	T2000 Kl.III T2000 Cl.III	SB250 Kl.I SB250 Cl.I	SB250 Kl.II SB250 Cl.II	SB250 Kl.III SB250 Cl.III
400mm	K4B01..	K4201..	K4201MT	K6201..	K6201MT	K6B01..	K6L01..	K7201..	K7B01..	K7L01..
700mm	K4B02..	K4202..	K4202MT	K6202..	K6202MT	K6B02..	K6L02..	K7202..	K7B02..	K7L02..
900mm	K4B03..	K4203..	K4203MT	K6203..	K6203MT	K6B03..	K6L03..	K7203..	K7B03..	K7L03..
1100mm				K6204..	K6204MT	K6B04..	K6L04			

\* MT = Met tekst of eigen picto  
\* MT = Avec texte ou propre picto



	VIN.	Plat Alu Alu Plat	T2000 Kl.I T2000 Cl.I	T2000 Kl.II T2000 Cl.II	T2000 Kl.III T2000 Cl.III	SB250 Kl.I SB250 Cl.I	SB250 Kl.II SB250 Cl.II	SB250 Kl.III SB250 Cl.III
400mm	K4C01..	K4301..	K6301..	K6C01..	K6M01..	K7301..	K7C01..	K7M01..
700mm	K4C02..	K4302..	K6302..	K6C02..	K6M02..	K7302..	K7C02..	K7M02..
900mm	K4C03..	K4303..	K6303..	K6C03..	K6M03..	K7303..	K7C03..	K7M03..



## Borden

## Panneaux

### Klasse I - Retroreflecterend

### Classe I - Rétro réfléchissants



	Plat Alu Alu plat	T2000 T2000	SB250 SB250	Plat Alu MT* Alu plat MT*	T2000 MT* T2000 MT*	SB250 MT* SB250 MT*
400x400mm	K4414..	K6414..	K5414..	K4414MT	K6414MT	K5414MT
500x500mm		K6438..			K6438MT	
600x600mm	K4436..	K6436..		K4436MT	K6436MT	
700x700mm	K4420..	K6420..	K5420..	K4420MT	K6420MT	K5420MT



	Plat Alu Alu plat	T2000 T2000	SB250 SB250	Plat Alu MT* Alu plat MT*	T2000 MT* T2000 MT*	SB250 MT* SB250 MT*
100x400mm	K4410..	K6410..	K5410..	K4410MT	K6410MT	K5410MT
300x400mm	K4413..	K6413..	K5423..	K4413MT	K6413MT	K5413MT
400x100mm	K4410..	K6410..	K5440..	K4410MT	K6410MT	K5410MT
400x200mm	K4411..	K6411..	K5411..	K4411MT	K6411MT	K5411MT
400x300mm	K4413..	K6413..	K5413..	K4413MT	K6413MT	K5413MT
400x600mm	K4415..	K6415..	K5415..	K4415MT	K6415MT	K5415MT
400x700mm	K4419..	K6419..	K5422..	K4419MT	K6419MT	K5419MT
600x400mm	K4415..	K6415..	K5418..	K4415MT	K6415MT	K5415MT
600x900mm	K4416..	K6416..	K5416..	K4416MT	K6416MT	K5416MT
700x200mm	K4417..	K6417..	K5417..	K4417MT	K6417MT	K5417MT
700x400mm	K4419..	K6419..	K5419..	K4419MT	K6419MT	K5419MT
900x600mm	K4416..	K6416..	K5421..	K4416MT	K6416MT	K5416MT
1100x300mm	K4426..	K6426..	K5426..	K4426MT	K6426MT	K5426MT
1100x700mm	K4427..	K6427..	K5427..	K4427MT	K6427MT	K5427MT
1200x150mm	K4428..	K6428..	K5428..	K4428MT	K6428MT	K5428MT
1200x250mm	K4429..	K6429..	K5429..	K4429MT	K6429MT	K5429MT

\* = Met tekst  
\* = Avec texte

Andere afmetingen op aanvraag  
Autres dimensions sur demande



Indien u een blanco bord wenst dient u één van de volgende letters toe te voegen aan de artikelcode.  
Si vous désirez un panneau vierge il est essentiel d'ajouter une des lettres suivantes au code de l'article.

B : Blauw / Bleu  
W : Wit / Blanc  
GE : Geel / Jaune  
O : Oranje / Orange  
GR : Groen / Vert  
R : Rood / Rouge

Vb./Ex. : K6410B = 100x400 - Blanco Blauw / Bleu

Voorzijde  
Front

Achterzijde  
Dos



Alu plat



Alu type 2000



Alu type 250

## Borden pijlvorm

## Panneaux en flèche

### Klasse I - Retroreflecterend

### Classe I - Rétro réfléchissants

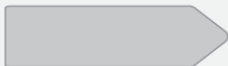

	Plat Alu Alu plat	T2000 Blanco	SB250 Blanco	Plat Alu MT* Alu plat MT*	T2000 MT* T2000 MT*	SB250 MT* SB250 MT*
850x200mm	K4508..	K6508..	K5508..	K4508MT	K6508MT	K5508MT
1000x200mm			K5514			K5514MT
1150x200mm	K4509..	K6509..	K5509..	K4509MT	K6509MT	K5509MT
1250x300mm	K4511..	K6511..	K5511..	K4511MT	K6511MT	K5511MT
1300x200mm	K4510..	K6510..		K4510MT	K6510MT	
1500x300mm	K4504..	K6504..	K5504..	K4504MT	K6504MT	K5504MT
1750x300mm	K4512..	K6512..	K5512..	K4512MT	K6512MT	K5512MT
2000x300mm	K4513..	K6513..	K5513..	K4513MT	K6513MT	K5513MT

\* = Met tekst  
\* = Avec texte

Andere afmetingen op aanvraag  
Autres dimensions sur demande

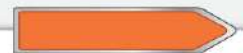

Indien u een blanco bord wenst dient u één van de volgende letters toe te voegen aan de artikelcode.  
Si vous désirez un panneau vierge il est essentiel d'ajouter une des lettres suivantes au code de l'article.

B : Blauw / Bleu  
W : Wit / Blanc  
GE : Geel / Jaune  
O : Oranje / Orange  
GR : Groen / Vert  
R : Rood / Rouge

Vb./Ex. : K6508O = 850x200 - Blanco Oranje / Orange

# WEGSIGNALISATIE

# SIGNALISATION ROUTIERE

## Gevaarsborden

## Panneaux de danger

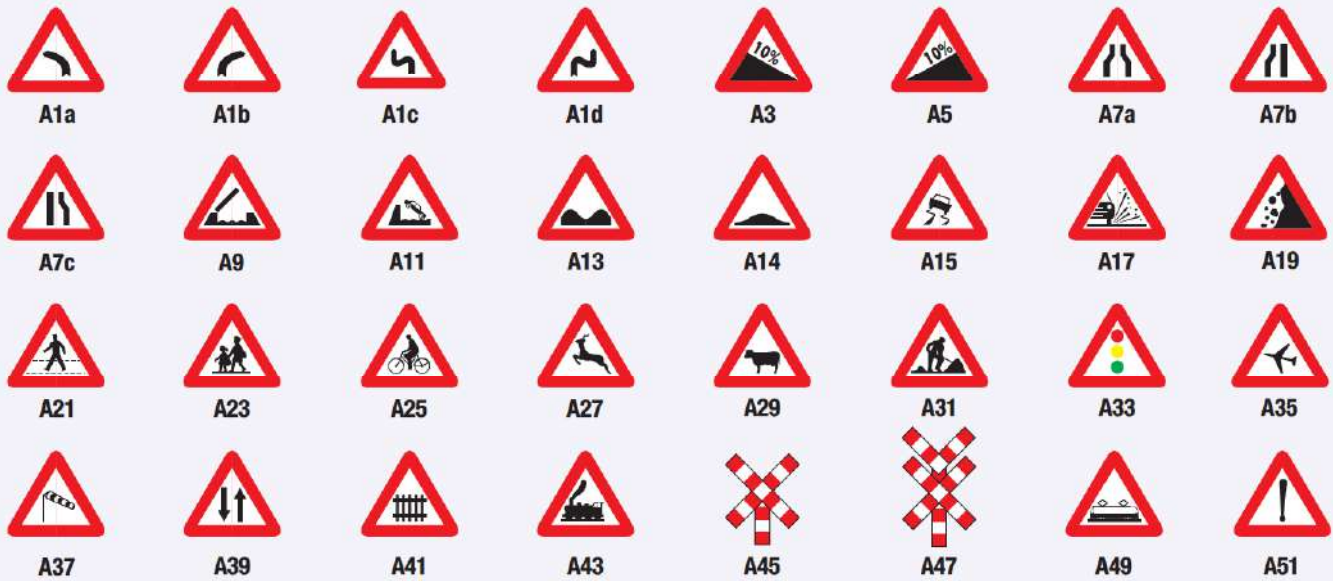

## Voorrangsborden

## Panneaux relatifs à la priorité



## Verbodsborden

## Panneaux d'interdiction



# WEGSIGNALISATIE

# SIGNALISATION ROUTIERE

## Gebodsborden

## Panneaux d'obligation

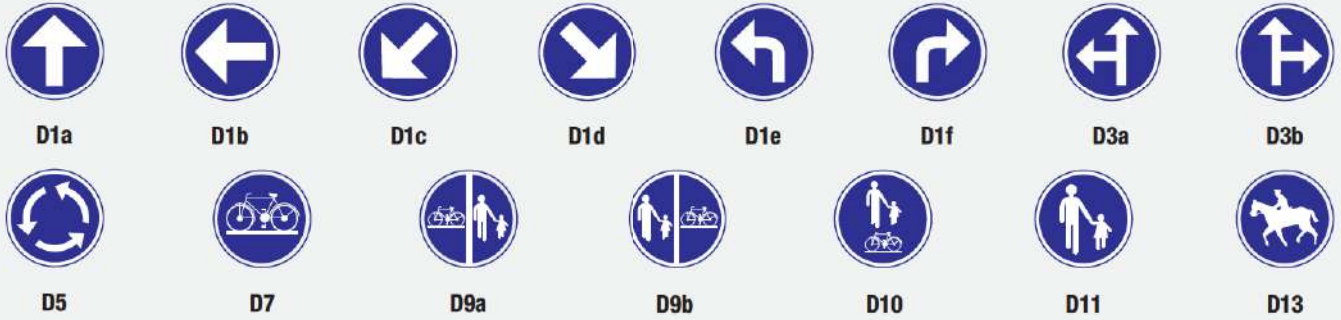

## Stilstaan en parkeren

## Panneaux relatifs à l'arrêt et au stationnement



## Zoneborden

## Panneaux à validité zonale

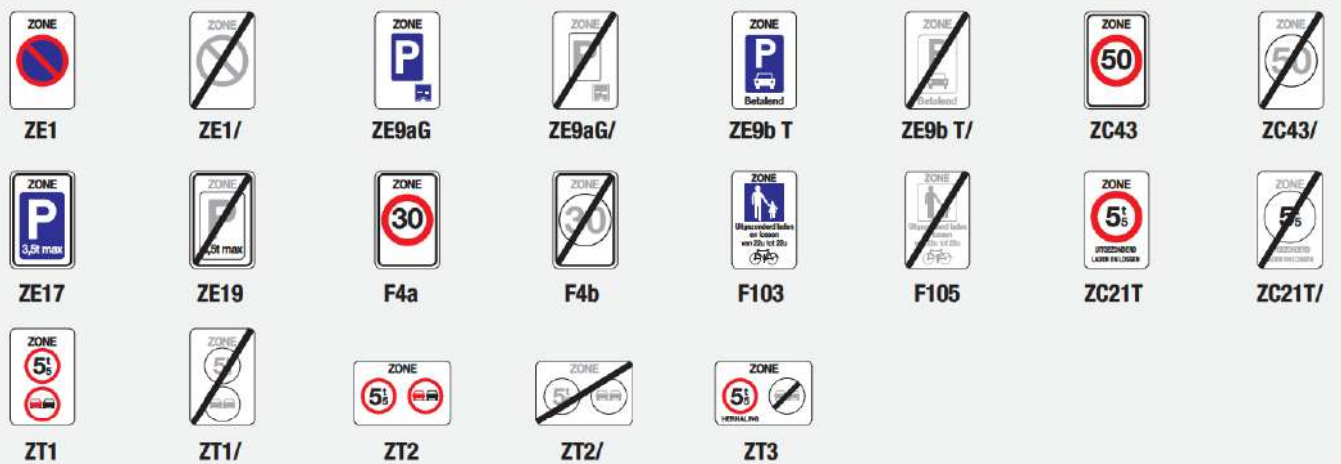

## Onderborden

## Panneaux additionnels

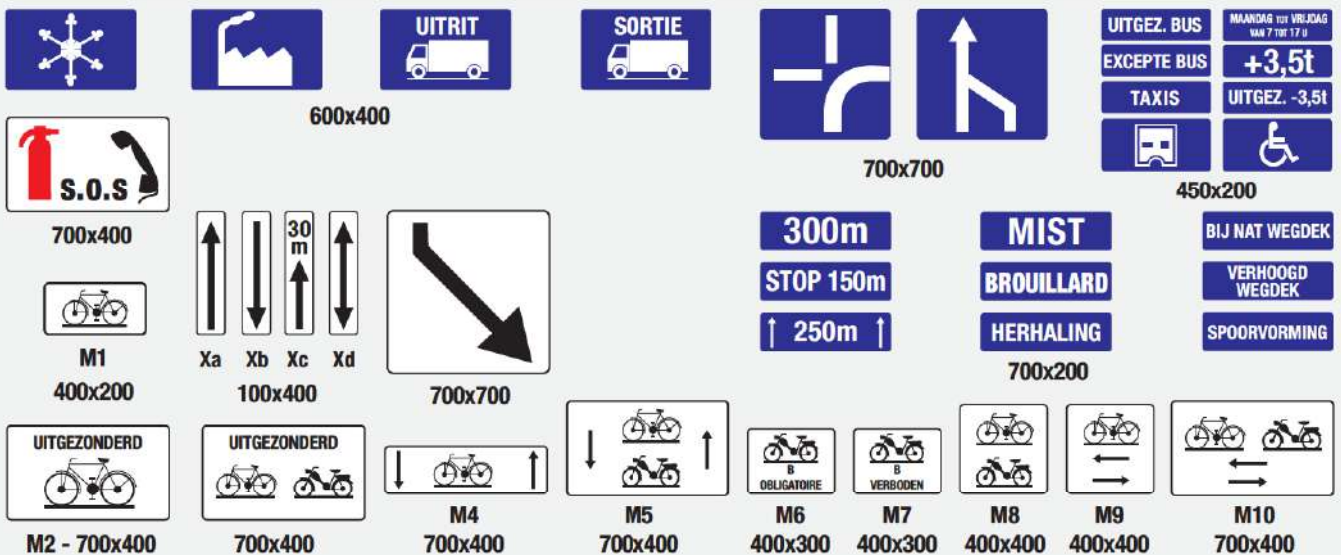

# WEGSIGNALISATIE

# SIGNALISATION ROUTIERE

Aanwijzingsborden

Panneaux d'indication

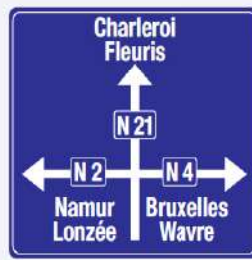
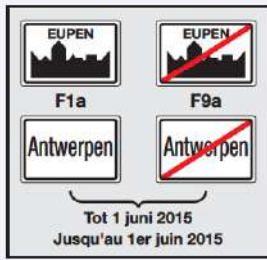

F25

F27



F5



F7



F8



F9



F11



F12a



F12b



F13



F14



F17



F19



F21



F23a



F23b



F23c



F23d



F29



F31



F33a



F33b



F41



F43



F34a



F34b1



F35



F45



F45b



F45L



F45R



F47



F49



F50



F51a



F51b



F53



F55



F56



F59



F61



F62



F63



F65



F67



F69



F71



F73



F75



F77



F87



F97a



F97b



F98



F107



F109



F89



F91



F99a



F99b



F99c



F101a



F101b



F101c





- Kunststof
- Reflectoren in de tussenstukken
- Met uitsparing voor stang
- Matière synthétique
- Réflecteurs dans les parties centrales
- Avec encoche pour barre

Tussenstukken Éléments droits	Geel Jaune	Zwart Noir
5cm-500x420mm	K1502	K1501
7,5cm-500x485mm	K1752	K1751

Afrondingen Éléments arrondis	Geel Jaune	Zwart Noir
5cm-220x420mm	K2502	K2501
7,5cm-250x485mm	K2752	K2751



- 4 bevestigingen per tussenstuk
- 2 bevestigingen per afronding
- 4 fixations par élément droit
- 2 fixations par élément arrondi



- Stang ter versteviging
- Verlengt levensduur
- Barre de renforcement
- Prolonge la durée de vie

	1m	1,5m	2m	Lopende meter Mètre courant
Ankerbout M12 met 1 sluitring Ancre boulon M12 avec 1 rondelle	100mm	B67006		
Asfaltbout M10 met 1 sluitring + plug Boulon asphalte M10 avec 1 rondelle + cheville	105mm	B67002		
Voor drempel 5cm Pour ralentisseur 5cm				K3103
Voor drempel 7,5cm Pour ralentisseur 7,5cm	K3111	K3112	K3113	



- Rubber
- 220mm diam. - 40mm dikte
- Caoutchouc
- 220mm diam. - épaisseur 40mm

Geel/Zwart Jaune/Noir	Blauw/Zwart Bleu/Noir	Wit/Zwart Blanc/Noir	Groen/Zwart Vert/Noir	Geel Jaune	Bevestiging Fixation
K05900	K05901	K05902	K05903	K05904	K0591

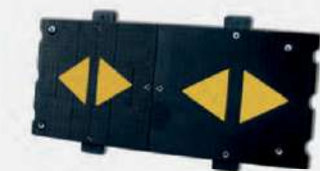

K05040

Rubber Caoutchouc	
500x500x50mm	K05020
1200x500x60mm	K05040
1700x500x60mm	K05050



K05040



K05022

K05020

K05021

Afronding voor K0502 Élément arrondi pour K0502	Rubber Caoutchouc
500x250x50mm-mannelijk/mâle	K05021
500x250x50mm-vrouwelijk/femelle	K05022



K0582

Rubber / Caoutchouc	
1700x1700x60mm	K0581
2200x1700x60mm	K0582



K0581

Toegangshellingen

Rampes d'accès

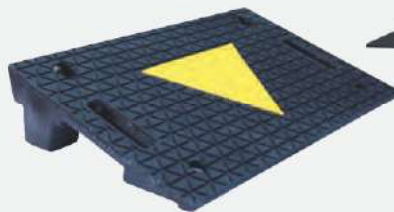

Rubber / Caoutchouc	
500x320x80mm	K0598
500x320x100mm	K0599



Verhoogstuk voor K0598 - K0599  
Maximum 2 stuks gebruiken

Adaption hauteur pour K0598 - K0599  
Maximum 2 pièces à utiliser

Rubber / Caoutchouc	
500x320x20mm	K0592

Stoatkussen

Coussin butoir



Met reflecterende strook  
Avec bande réfléchissante

Rubber / Caoutchouc	
870x152x102mm	K0595
1820x152x102mm	K0596
600x150x115mm	K0597



K0595

K0596

Meer stootbescherming?

Plus de choix  
en protection collision?



Pag. 243



Pag. 250

Afbakeningsrondjes

Plots de chaussée



• Diam. 120mm  
• zonder flap

• Diam. 120mm  
• sans drapeau

	Geel	Wit
Zonder reflector Sans réflecteur	KK0G	KK0W
1 zijde gele reflectoren Réflecteurs jaunes 1 côté	KK1G	KK1W
2 zijden gele reflectoren Réflecteurs jaunes 2 côtés	KK2G	KK2W



• Diam. 120mm  
• Flap zonder reflector

• Diam. 120mm  
• Drapeau sans réflecteur

	Geel	Wit
Zonder reflector Sans réflecteur	KK0FG	
1 zijde gele reflectoren Réflecteurs jaunes 1 côté	KK1FG	KK1FW
2 zijden gele reflectoren Réflecteurs jaunes 2 côtés	KK2FG	KK2FW



• Diam. 120mm  
• Flap met reflector

• Diam. 120mm  
• Drapeau avec réflecteur

	Geel
2 zijden gele reflectoren Réflecteurs jaunes 2 côtés	KK2FRG

# KABEL- & SLANGBESCHERMING

# PROTECTION CABLES & TUYAUX

## Binnengebruik

## Usage intérieur

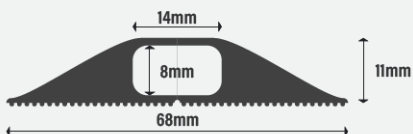

TYPE STANDARD	Zwart / Noir	Doorschijnend / Translucide
3m	C103.01	C203.01
9m	C109.01	C209.01

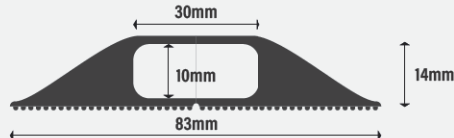

TYPE B	Zwart / Noir	Doorschijnend / Translucide
3m	C113.01	C213.01
9m	C119.01	C219.01

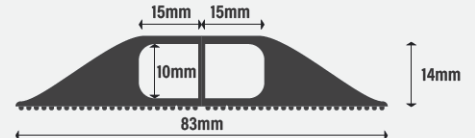

TYPE BNCI	Zwart / Noir
3m	C123.01
9m	C129.01

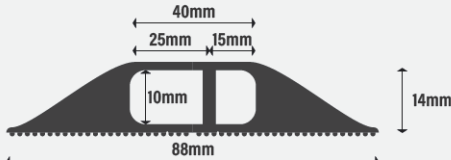

TYPE BNC2	Zwart / Noir
3m	C133.01
9m	C139.01

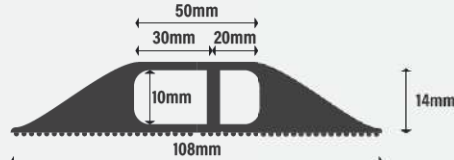

TYPE BNC3	Zwart / Noir
4,5m	C144.01



## Met gele waarschuwingsstrip

## Avec bande jaune d'avertissement

### Binnengebruik

### Usage intérieur

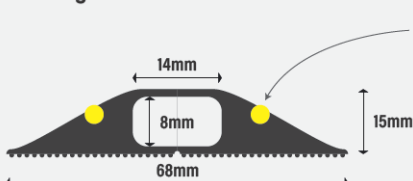

TYPE HAZ1	Zwart / Noir
3m	C303.01
9m	C309.01

Waarschuingsstrip  
Bande d'avertissement

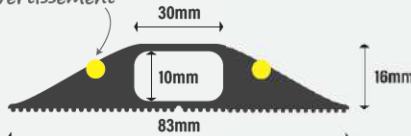

TYPE HAZ2	Zwart / Noir
3m	C313.01
9m	C319.01

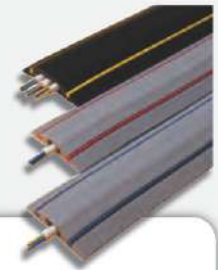

Andere modellen en kleuren op aanvraag.  
Autres modèles et couleurs sur demande.

## Cable safe safety hook

## Cable safe safety hook

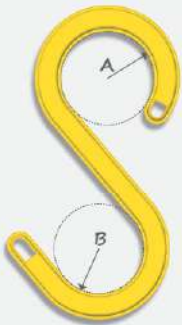

	Lengte Largeur	ØA	ØB	Maximum gewicht Poids maximum	Kleur Couleur
CS6W	160mm	29mm	29mm	40kg	☐
CS6Y	160mm	29mm	29mm	40kg	☐
CS6GITD	160mm	29mm	29mm	40kg	☐
CS9W	230mm	45mm	70mm	55kg	☐
CS9Y	230mm	45mm	70mm	55kg	☐
CS9GITD	230mm	45mm	70mm	55kg	☐
CS12W	310mm	54mm	89mm	190kg	☐
CS12Y	310mm	54mm	89mm	190kg	☐
CS12GITD	310mm	54mm	89mm	190kg	☐
CS15W	380mm	64mm	114mm	300kg	☐
CS15Y	380mm	64mm	114mm	300kg	☐
CS15GITD	380mm	64mm	114mm	300kg	☐



# KABEL- & SLANGBESCHERMING

Industrieel binnen- en buitengebruik

# PROTECTION CABLES & TUYAUX

Utilisation industrielle intérieure et extérieure

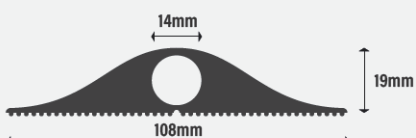

TYPE A Zwart / Noir  
9m C459.01

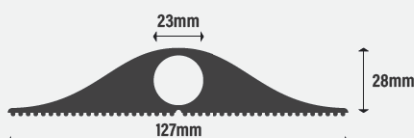

TYPE F Zwart / Noir  
4,5m C404.01  
9m C409.01

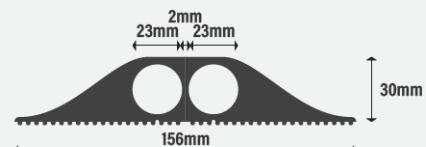

TYPE FF Zwart / Noir  
4,5m C414.01

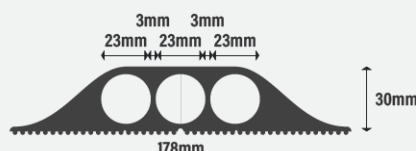

TYPE FF Zwart / Noir  
4,5m C424.01

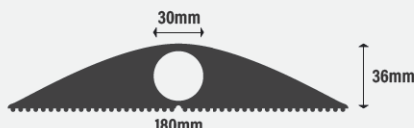

TYPE G Zwart / Noir  
4,5m C434.01

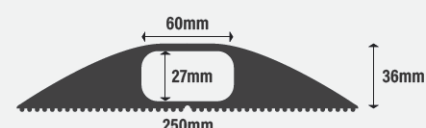

TYPE H Zwart / Noir  
1,5m C441.01

## Verkeersdrempel met gele waarschuwingsstrip

## Ralentisseur avec bande jaune d'avertissement

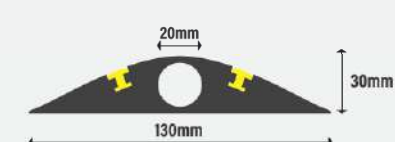

TYPE TTC/1 Zwart-Geel / Noir-Jaune  
4,5m C504.01

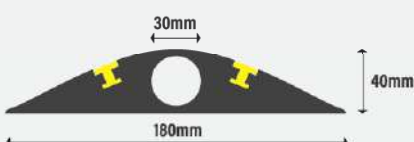

TYPE TTC/2 Zwart-Geel / Noir-Jaune  
4,5m C514.01

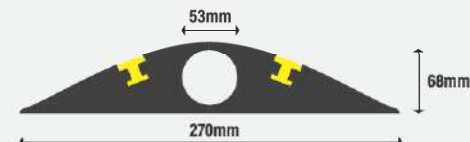

TYPE TTC/3 Zwart-Geel / Noir-Jaune  
1,5m C521.01

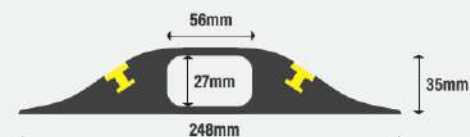

TYPE TTC/4 Zwart-Geel / Noir-Jaune  
1,5m C531.01



## Kabelbescherming

## Protection cables

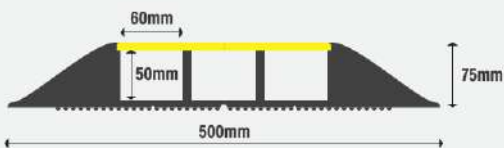

900x500x75mm K051

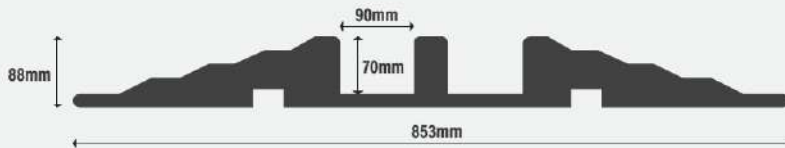

853x300x88mm K052



# STOOTBANDEN

POLYURETHAAN

# AMORTISSEURS DE CHOC

POLYURETHANE

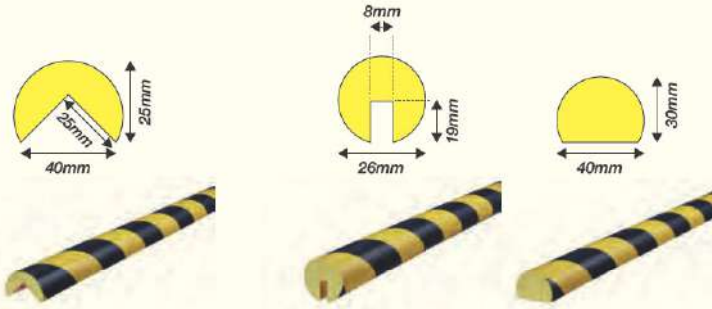

Magneetstrip  
Bande magnétique



Installatie tot -10 °C  
Installation chez jusqu'à -10 °C



Verwijderbaar/Herbruikbaar  
Amovible/Réutilisable

Zelfklevend / Autocollante	Type A	Type B	Type C
Geel / Zwart Jaune / Noir	1mtr 3751.01 37G1.01 37L1.01 37J1.01 5mtr 3761.01	3752.01 3762.01	3753.01 3763.01
Rood / Wit Rouge / Blanc	1mtr 3751.02 37G1.02 37L1.02 37J1.02 5mtr 3761.02	3752.02 3762.02	3753.02 3763.02
Wit Blanc	1mtr 3751.03 37G1.03 37L1.03 37J1.03 5mtr 3751.03	3752.03 3762.03	3753.03 3763.03
Zwart Noir	1mtr 3751.04 37G1.04 37L1.04 37J1.04 5mtr 3751.04	3752.04 3762.04	3753.04 3763.04
FLUO Geel / Zwart FLUO Jaune / Noir	1mtr 37A1.05 37G1.05 37L1.05 37J1.05 5mtr 3761.05	37A2.05 3762.05	37A3.05 3763.05
Fotoluminescerend / Zwart Photoluminescent / Noir	1mtr 37B1.06 5mtr	37B2.06	37B3.06

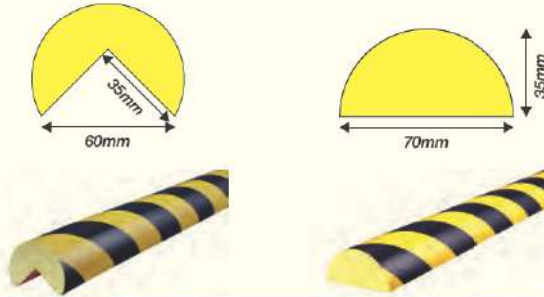

Zelfklevend / Autocollante	Type A+	Type C+
Geel / Zwart Jaune / Noir	1mtr 375K.01	375L.01
Rood / Wit Rouge / Blanc	1mtr 375K.02	375L.02
Wit Blanc	1mtr 375K.03	375L.03
Zwart Noir	1mtr 375K.04	375L.04
Rood / Wit Reflecterend Rouge / Blanc Réfléchissant	1mtr 37CK.07	37CL.07
Geel / Zwart Reflecterend Jaune / Noir Réfléchissant	1mtr 37HK.08	37HL.08
Fotoluminescerend / Zwart Photoluminescent / Noir	1mtr	375L.05
FLUO Geel / Zwart FLUO Jaune / Noir	1mtr 37AK.05	

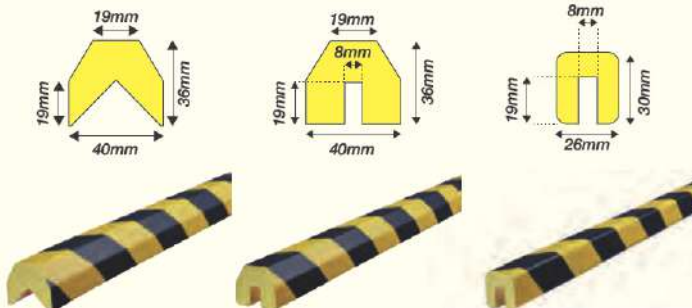

Zelfklevend / Autocollante	Type AA	Type BB	Type G
Geel / Zwart Jaune / Noir	1mtr 3756.01 5mtr 3766.01	3757.01 3767.01	375A.01 376A.01
Rood / Wit Rouge / Blanc	1mtr 3756.02 5mtr 3766.02	3757.02 3767.02	375A.02 376A.02
Wit Blanc	1mtr 3756.03 5mtr 3766.03	3757.03 3767.03	375A.03 376A.03
Zwart Noir	1mtr 3756.04 5mtr 3766.04	3757.04 3767.04	375A.04 376A.04



ROOD / WIT - GEEL/ZWART - reflecterend - Beschikbaar in Type A+, C+ en H+  
ROUGE / BLANC - JAUNE/NOIR - réfléchissant - Disponible en Type A+, C+ et H+

# STOOTBANDEN

POLYURETHAAN

# AMORTISSEURS DE CHOC

POLYURETHANE

AMORTISSEURS DE CHOC

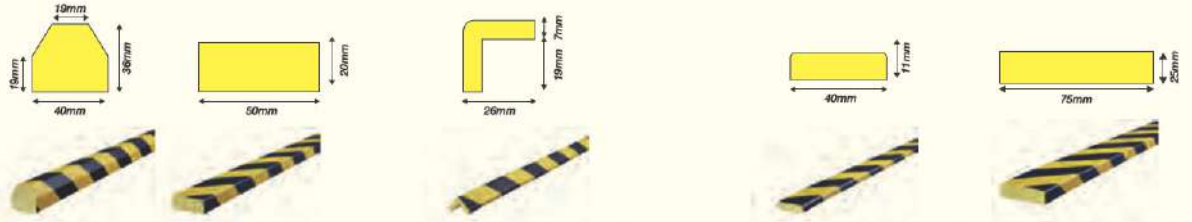

Zelfklevend / Autocollante	Type CC	Type D	Type E	Type F	Type S
Geel / Zwart Jaune / Noir	1 mtr 3758.01 5 mtr 3768.01	3754.01 3764.01	3755.01 3765.01	3759.01 3769.01	3751.01
Rood / Wit Rouge / Blanc	1 mtr 3758.02 5 mtr 3768.02	3754.02 3764.02	3755.02 3765.02	3759.02 3769.02	3751.02
Wit Blanc	1 mtr 3758.03 5 mtr 3768.03	3754.03 3764.03	3755.03 3765.03	3759.03 3769.03	3751.03
Zwart Noir	1 mtr 3758.04 5 mtr 3768.04	3754.04 3764.04	3755.04 3765.04	3759.04 3769.04	3751.04

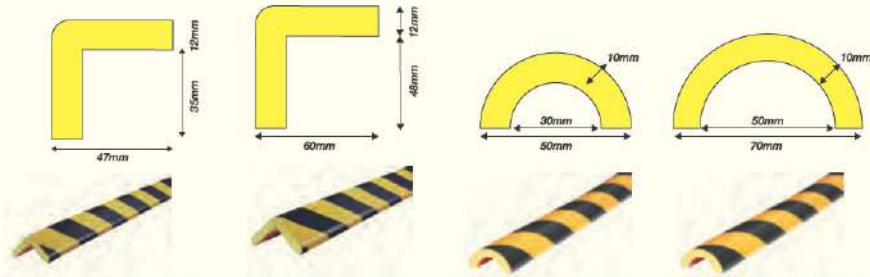

Zelfklevend / Autocollante	Type H	Type H+	Type R30	Type R50
Geel / Zwart Jaune / Noir	1 mtr 375C.01 5 mtr 376C.01	375H.01	375E.01 376E.01	375F.01
Rood / Wit Rouge / Blanc	1 mtr 375C.02 5 mtr 376C.02	375H.02	375E.02 376E.02	375F.02
Wit Blanc	1 mtr 375C.03 5 mtr 376C.03	375H.03	375E.03 376E.03	375F.03
Zwart Noir	1 mtr 375C.04 5 mtr 376C.04	375H.04	375E.04 376E.04	375F.04
Rood / Wit Reflecterend Rouge / Blanc Réfléchissant	1 mtr 5 mtr	37CH.07		
Geel / Zwart Reflecterend Jaune / Noir Réfléchissant	1 mtr 5 mtr	37HH.08		



	Type B+	Type W
Geel / Zwart Jaune / Noir	1 mtr 375M.01 5 mtr 375M.04	375N.01 376N.01
Zwart Noir	1 mtr 375M.04 5 mtr 375M.04	375N.04 376N.04
Fluo Geel / Zwart Fluo Jaune / Noir	1 mtr 37AM.05 5 mtr 37AM.05	37AN.05 376N.05

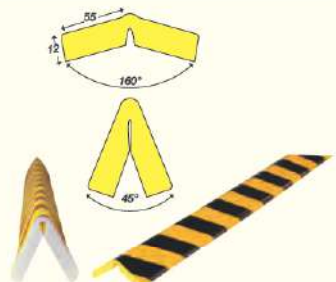

Zelfklevend / Autocollante	Type H+ FLEX
Geel / Zwart Jaune / Noir	1 mtr 37VH.01
Fluo Geel / Rood Fluo Jaune / Rouge	1 mtr 37WH.09

- Magneetstrip**  
Bande magnétique
- Installatie tot -10 °C**  
Installation chez jusqu'à -10 °C
- Verwijderbaar / Herbruikbaar**  
Amovible / Réutilisable

STOOTBANDEN

# STOOTBANDEN

Met RVS-muurplaten

Polyurethaan - Bevestigingen inbegrepen

# AMORTISSEURS DE CHOC

Avec plaques murales inox

Polyuréthane - Fixations incluses

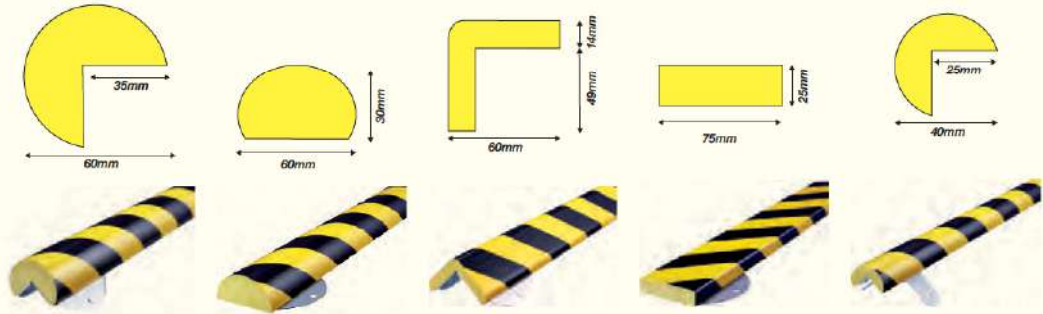

	Type A+	Type C+	Type H+	Type S	Type A
Geel / Zwart Jaune / Noir	0.5 mtr 1 mtr	37MK.01 37DK.01	37ML.01 37DL.01	37MH.01 37DH.01	37ML.01 37DL.01 37D1.01
Rood / Wit Reflecterend Rouge / Blanc Réfléchissant	0.5 mtr 1 mtr	37FK.07 37FL.07	37FH.07	37EI.05	
FLUO Geel / Zwart FLUO Jaune / Noir	0.5 mtr 1 mtr	37PK.05 37EK.05	37PL.05 37EL.05	37PH.05 37EH.05	37PI.05
Geel / Zwart Reflecterend Jaune / Noir Réfléchissant	0.5 mtr 1 mtr	37KK.08 37KL.08	37KH.08		

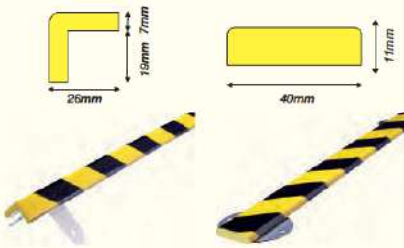

	Type E	Type F
Geel / Zwart Jaune / Noir	0.5 mtr 1 mtr	37D5.01 37D9.01



## Stootherken

## Coins amortisseurs



	Type A - Zelfklevend / Autocollante		Type E - Zelfklevend / Autocollante		Type H - Zelfklevend / Autocollante	
	ZWART/NOIR	WIT/BLANC	ZWART/NOIR	WIT/BLANC	ZWART/NOIR	WIT/BLANC
2D	3771.01	377G.03	3773.01	377J.03	3775.01	377L.03
3D	3772.01	377H.03	3774.01	377K.03	3776.01	377M.03

## Muurbescherming

## Protection murale



Muurbeschermer in schuim / Mousse de protection murale  
1500x1000x10mm 3785.01

## Kolombescherming

## Protection colonne



- Hoogte 1100mm
- Polyethyleen
- Hauteur 1100mm
- Polyéthylène

Diam.	Balk / Poteau	
620mm	160x160mm	K038.A
620mm	210x210mm	K038.B
620mm	260x260mm	K038.C



- Hoogte 450mm
- Breedte 160mm
- Polyethyleen
- Hauteur 450mm
- Largeur 160mm
- Polyéthylène

Rack	
80mm	K04001
90mm	K04002
100mm	K04003

Geen extra bevestigingen nodig  
Pas de fixation nécessaires



400mm 600mm 1000mm

Balk / Poteau	diam.	diam.
	75-100mm	100-125mm
400mm	K04720	K04730
600mm	K04700	K04710
1000mm	K04740	K04750



L - profiel - staal  
Profile - L - acier

U - profiel - staal  
Profile - U - acier

HxBxD / HxLxP	
L 400x180x180mm	K045
U 400x245x200mm	K046



## Hoekbescherming

## Protection coin

Geschikt voor binnen- en buitengebruik

Pour usage intérieur et extérieur



Plat profiel - Polyethyleen  
Profil plat - Polyéthylène



L - Profiel - Polyethyleen  
Profilé - L - Polyéthylène

Plat-	600x250mm-BxH/LxH	K041
L-	600x250x150mm-HxBxD/HxLxP	K042



DIBOND 3mm	Geel - Zwart Jaune - Noir	Rood - Wit Rouge - Blanc	Met uw eigen tekst en/of symbolen Avec votre propre texte et/ou symboles
500x50x50mm	K048.11	K048.12	K0481.MT
1000x50x50mm	K048.21	K048.22	K0482.MT
500x100x100mm	K048.31	K048.32	K0483.MT
1000x100x100mm	K048.41	K048.42	K0484.MT

## Veiligheidsreling DELTA

d-flexx

## Rampe de sécurité DELTA

Op maat gemaakte opstelling mogelijk - Geleverd met bevestigingsmaterialen - Geschikt voor binnen- en buitengebruik - Flexibel bij aanrijding  
Composition sur mesure possible - Livrée avec fixations - Pour usage intérieur et extérieur - Flexible en cas de collision

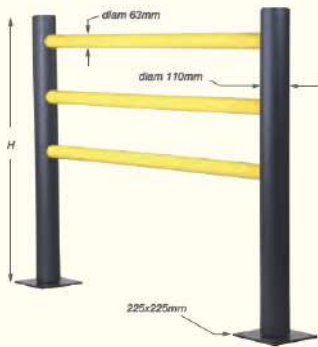

	3 balken / poutres		4 balken / poutres	
	H:	1200mm	1200mm	1600mm
Hoeksteun 90° / Support coin 90°	K08610	K08614A	K08614B	
Verbindingssteun / Support connexion	K08620	K08624A	K08624B	
Eindsteun / Support finition	K08630	K08634A	K08634B	
T-verbinding / Connecteur T	K08660	K08664A	K08664B	
X-verbinding / Connecteur X	K08670	K08674A	K08674B	
Vrijstaande paal	K08690			
Mobiele grondplaat	K086SP			
	<b>Balken / Poutres</b>	<b>3 st / pcs</b>	<b>4 st / pcs</b>	
	150mm	K08640	K08644	
	prijs/m / prix/m	K08650	K08654	



## Veiligheidsreling FOXTROT

d-flexx

## Rampe de sécurité FOXTROT

Geleverd met bevestigingsmaterialen - Geschikt voor binnen- en buitengebruik - Flexibel bij aanrijding  
Livrée avec fixations - Pour usage intérieur et extérieur - Flexible en cas de collision



	H:	1200mm
L: 1000mm	K08710	
L: 1500mm	K08720	
L: 2000mm	K08730	



## Verkeersbarrières CHARLIE en HOTEL

d-flexx

## Barrières traffic CHARLIE et HOTEL

Op maat gemaakte opstelling mogelijk - Geleverd met bevestigingsmaterialen - Geschikt voor binnen- en buitengebruik - Flexibel bij aanrijding  
Composition sur mesure possible - Livrée avec fixations - Pour usage intérieur et extérieur - Flexible en cas de collision



CHARLIE	Palen / Poteaux	516mm
	Eindsteun / Support finition	K08110
	Verbindingssteun / Support connexion	K08120
CHARLIE	Balk / Poutre	1 st / pcs
	930mm	K08130
	prijs/m / prix/m	K08140

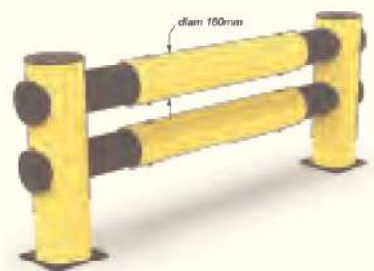

HOTEL	Palen / Poteaux	706mm
	Eindsteun / Support finition	K08150
	Verbindingssteun / Support connexion	K08160
HOTEL	Balken / Poutres	2 st / pcs
	930mm	K08170
	prijs/m / prix/m	K08180



## Veiligheidsbarrière GOLF

**d-flexx**

## Barrière de sécurité GOLF

Meedraaiende eindsteun voor een hogere impact absorptie - Geleverd met bevestigingsmaterialen - Geschikt voor binnen- en buitengebruik  
Support finition tournante pour une absorption d'impact plus élevée - Livrée avec fixations - Pour usage intérieur et extérieur

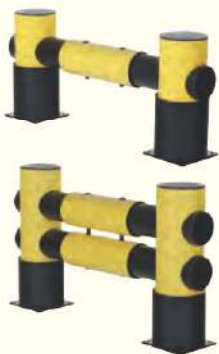

Enkele rail / Rail seul		H:	516mm
L:	1100mm		K08200
L:	2500mm		K08210
Dubbele rail / Rail double		H:	760mm
L:	1100mm		K08200
L:	2500mm		K08210



## Dock gate NOVEMBER

**d-flexx**

## Dock gate NOVEMBER

Voor een betere veiligheid rond los- en laadkaaien - Geleverd met bevestigingsmaterialen - Geschikt voor binnen- en buitengebruik  
Pour améliorer la sécurité dans les espaces de chargement - Livrée avec fixations - Pour usage intérieur et extérieur



		H:	585mm
L:	2750mm		K04781
L:	3050mm		K04782



## Verkeersbarrière ECHO

**d-flexx**

## Barrière traffic ECHO

Op maat gemaakte opstelling mogelijk - Geleverd met bevestigingsmaterialen - Geschikt voor binnen- en buitengebruik  
Composition sur mesure possible - Livrée avec fixations - Pour usage intérieur et extérieur



Palen / Poteaux		1200mm
Eindsteun / Poteau d'extrémité		K08310
Centraal / Intermédiaire		K08320
Hoek 90° links / Coin 90° gauche		K08330
Hoek 90° rechts / Coin 90° droite		K08340

Balken / Poutres		3+1st / pcs
	1510mm	K08350
prijs/m / prix/m		K08360



Palen / Poteaux		1200mm
Eindsteun / Poteau d'extrémité		K08510
Centraal / Intermédiaire		K08520

Balken / Poutres		2+2 st / pcs
	1500mm	K08530
prijs/m / prix/m		K08540



## Veiligheidsreling KILO

**d-flexx**

## Rampe de sécurité KILO

Geleverd met bevestigingsmaterialen - Geschikt voor binnen- en buitengebruik  
Livrée avec fixations - Pour usage intérieur et extérieur



		H:	1200mm
L:	1000mm		K08740
L:	1500mm		K08750
L:	2000mm		K08760



Deuren OSCAR en JULIET

**d-flexx**

Portes OSCAR et JULIET

In combinatie met DELTA of ECHO - Geleverd met bevestigingsmaterialen - Geschikt voor binnen- en buitengebruik  
 Combinez avec système DELTA ou ECHO - Livrée avec fixations - Pour usage intérieur et extérieur

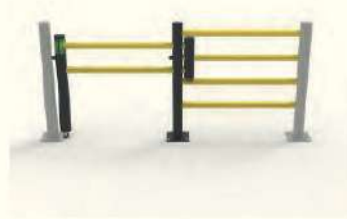

Schuifdeur / Porte coulissante OSCAR	DELTA	DELTA (4)
H:	1200mm	1200mm
L: 1000mm	K08691	K086914A
L: 1200mm	K08692	K086924A
L: 1500mm	K08693	K086934A

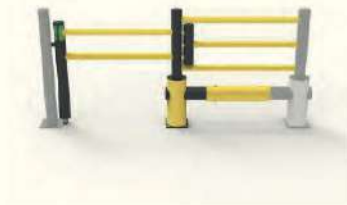

Schuifdeur / Porte coulissante OSCAR	ECHO
H:	1200mm
L: 1000mm	K08371
L: 1200mm	K08372
L: 1500mm	K08373

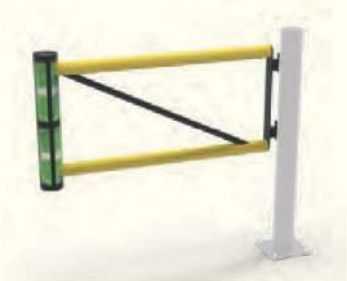

Klapdeur / Porte battante JULIET	H:	1200mm
L: 1000mm	K08680	
L: 1200mm	K08681	
L: 1500mm	K08682	
L: 1750mm	K08683	
L: 2000mm	K08684	

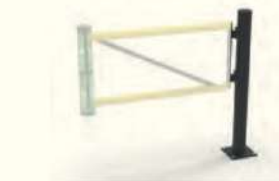

Palen / Poteaux DELTA	H:	1200mm
Eindsteun / Poteau d'extrémité	K08631	
"T" (3-way)	K08661	
Hoek 90° links / Coin 90° gauche	K08611	
Hoek 90° rechts / Coin 90° droite	K08612	
Centraal / Intermédiaire	K08621	



Palen / Poteaux ECHO	H:	1200mm
Eindsteun / Poteau d'extrémité	K08311	
"T" (3-way)	K08321	
Hoek 90° links / Coin 90° gauche	K08331	
Hoek 90° rechts / Coin 90° droite	K08341	



Grondbescherming MIKE

**d-flexx**

Barrière trottoir MIKE

Geleverd met bevestigingsmaterialen - Geschikt voor binnen- en buitengebruik  
 Livrée avec fixations - Pour usage intérieur et extérieur



H:	140mm
L: 500mm	K04771
L: 1000mm	K04772
L: 1300mm	K04773
L: 1500mm	K04774
L: 2000mm	K04775



Mobiele grondplaat

**d-flexx**

Platine mobile

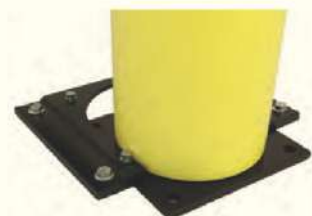

K086SP

Geschikt voor / Pour	
BRAVO - CHARLIE - ECHO - HOTEL - LIMA	K083SP
DELTA - FOXROT	K086SP



K083SP



**PIKT-O-NORM**

## Veiligheidspaal BRAVO

**d-flexx**

## Poteau de sécurité BRAVO

Hoge impact absorptie - Geleverd met bevestigingsmaterialen - Geschikt voor binnen- en buitengebruik  
Absorption à haute impact - Livré avec fixations - Pour usage intérieur et extérieur

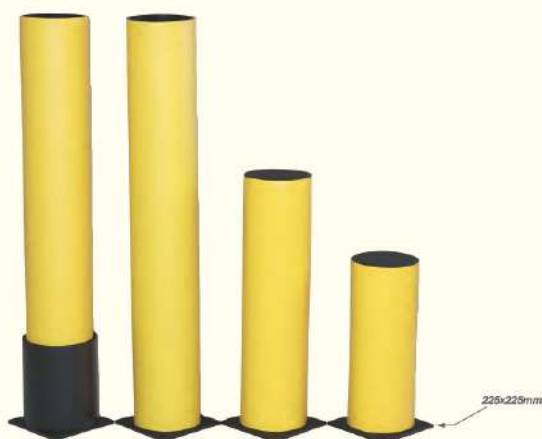

H:	Ø	
516mm	200mm	K08810
760mm	200mm	K08820
1200mm	200mm	K08830
1200mm	225mm	K08840



## Beschermingsbarrières

## Barrières protection

Geschikt voor binnen- en buitengebruik - Exclusief bevestigingsmaterialen  
\*K03A is enkel geschikt voor binnengebruik

Pour usage intérieur et extérieur - Fixations non incluses  
\*K03A est seulement pour usage intérieur



Afmetingen-BxH Dimensions-LxH	Gegalvaniseerd + gepoedercoat staal Acier galvanisé + thermolacqué	Polyurethaan Polyuréthane
375x350mm	K0341	K1341
750x350mm	K0342	K1342
1000x350mm	K0343	K1343
750x600mm	K0344	K1344
1000x600mm	K0345	K1345
750x1200mm	K0346	K1346
1000x1200mm	K0347	K1347
8x Grondbevestiging / 8x Ancre sol	B67016	B67015



Polyurethaan  
Polyuréthane



Afmetingen-BxH Dimensions-LxH	Gepoedercoat staal* Acier thermolacqué*	Gepoedercoat staal met bord Acier thermolacqué avec plaque
375x350mm	K03A1	
750x350mm	K03A2	K03C2
1000x350mm	K03A3	K03C3
750x600mm	K03A4	K03C4
1000x600mm	K03A5	K03C5
750x1200mm	K03A6	
1000x1200mm	K03A7	
8x Grondbevestiging / 8x Ancre sol	B67012	B67012



Gepoedercoat staal\*  
Acier thermolacqué\*



Gepoedercoat staal met bord  
Acier thermolacqué avec plaque

Gebruik uw beschermingsbarrières als signalisatiedrager.  
Opmaak door te geven bij bestelling.

Utilisez vos barrières de protection comme porteur de signalisation.  
Lay-out à donner à la commande.

Voor breedte Pour largeur	Dibond 2mm Recto	Dibond 2mm R/V
375mm	K03D2MT	K03E2MT
750mm	K03D3MT	K03E3MT
1000mm	K03D4MT	K03E4MT

	Vinyl met laminaat Vinyile avec laminat
Voor/Pour K03C2	K03F2MT
Voor/Pour K03C3	K03F3MT
Voor/Pour K03C4	K03F4MT
Voor/Pour K03C5	K03F5MT



Kabelbinders inbegrepen  
Colliers inclus



## Beschermingsbarrières

## Barrières protection

Geschikt voor binnen- en buitengebruik - Exclusief bevestigingsmaterialen

Pour usage intérieur et extérieur - Fixations non incluses

Afmetingen-BxH Dimensions-LxH	Gegalvaniseerd + gepoedercoat staal Acier galvanisé + thermolaqué
600x600x350mm	K0351
600x600x600mm	K0352
600x600x1200mm	K0353



Afmetingen-BxH Dimensions-LxH	Gegalvaniseerd + gepoedercoat staal Acier galvanisé + thermolaqué	Polyurethaan Polyuréthane
400mmx76mm dia	K0361	
400mmx80mm dia		K1361
800mmx76mm dia	K0362	
800mmx80mm dia		K1362
1200mmx76mm dia	K0363	
1200mmx80mm dia		K1363
Bevestigingsset Set fixations	B67012	B67013



Afmetingen-HxDiam. Dimensions-HxDiam.	Gegalvaniseerd + gepoedercoat staal Acier galvanisé + thermolaqué	Polyurethaan Polyuréthane
1200x76mm	K0371	
1200x159mm	K0372	
1600x76mm	K0373*	
1600x159mm	K0374*	
1000x90mm		K1371
1000x159mm		K1372
1000x273mm		K1373
*om te betonnen / à bétonner		
Bevestigingsset Set fixations	B67014	B67013



## Veiligheidsreling

## Rampe de sécurité

Stalen bescherming voor rekken, productielijnen, magazijnen....  
Exclusief bevestigingsmaterialen

Protection en acier pour rayons, lignes de production, magasins....  
Fixations non incluses

	INDOOR		OUTDOOR
		Gepoederlakt Thermolaqué	Gegalvaniseerd + gepoederlakt Galvanisé + thermolaqué
Hoeksteun / Support coin	500mm	K060	K070
Hoeksteun / Support coin	1000mm	K061	K071
Verbindingssteun / Support connexion	500mm	K062	K072
Verbindingssteun / Support connexion	1000mm	K063	K073
Eindsteun / Support de finition	500mm	K064	K084
Eindsteun / Support de finition	1000mm	K065	K085
Balk / Poutre	1000mm	K066	K076
Balk / Poutre	1200mm	K067	K077
Balk / Poutre	1350mm	K068	K078
Balk / Poutre	1500mm	K069	K079

Grondbevestiging Galva / Ancre sol Galva B67017



80x160mm

100x100mm

200x200mm

B67017

# AFSLUITING

## Netten



- 50m per rol
- 50m le rouleau

	Oranje Orange
1mH-5,5kg	K032A
1mH-12kg	K032D



- Polyethyleen
- 100m per rol
- Polyéthylène
- 100m le rouleau

	Rood Rouge	Geel Jaune	Groen Vert	Blauw Bleu
300mm H	K032B01	K032B02	K032B03	K032B04



- Steun voor afbakeningsnet
- Support pour clôtures de chantier

1,19m H | K0329



- Stootkap voor piket
- Hard PP
- Haken voor linten, ketting, lampen, netten
- Voor piket van 8 tot 20mm

- Capuchon pour piquet
- PP dur
- Crochets pour rubans, chaînes, lampes, clôtures
- Pour piquet de 8 à 20mm



| K032C



- Stootkap voor piket
- Soepele Kunststof
- Capuchon pour piquet
- Mat. synthétique souple

6-12mm	377A.01
12-16mm	377C.01

Assortiment kettingen raadpleegbaar op pagina 220  
Assortiment chaînes à consulter page 220

## Bareel

## Barrière



2000x1000x1000mm | K0339

- |                            |                             |
|----------------------------|-----------------------------|
| • Klasse III reflectie     | • Réflexion classe III      |
| • Gegalvaniseerd           | • Galvanisée                |
| • 2 planken 2000x150x1,5mm | • 2 planches 2000x150x1,5mm |
| • Versterkte achterzijde   | • Derrière renforcé         |
| • Lampen niet inbegrepen   | • Lampes non-incluses       |



Telescopische barrières en PVC planken - pag. 221  
Barrières télescopiques et planches PVC - pag. 221

# AFSLUITING

## Harmonicahekken



- Metaal
- 1000mm hoogte
- Uitrekbaar tot 4000mm
- Gewicht 16kg
- Witte reflectie voorzijde
- Zonder wielen

K0330

# VERROUILLAGE

## Barrières harmonica



- Staal
- Uitrekbaar tot 3,6 of 4m

- 1050mm hoogte
- Op poten, met wielen of muurbevestiging

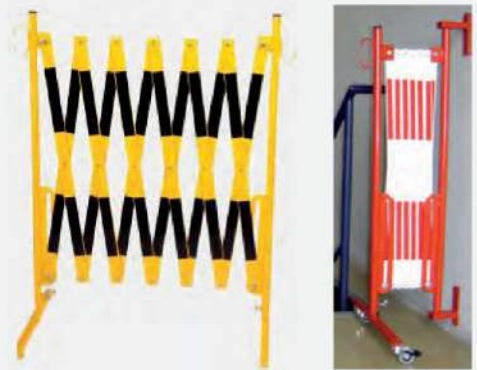

- Acier
- Extensibile jusqu'à 3,6 ou 4m

- Hauteur 1050mm
- Sur pieds, avec roulettes ou fixation murale

Op poten Sur pieds	Rood/Wit Rouge/Blanc	Geel/Zwart Jaune/Noir
3,6m	K033A01	K033A02
4,0m	K033B01	K033B02

Op poten en één zijde met wielen Sur pieds avec roulettes à une coté	Rood/Wit Rouge/Blanc	Geel/Zwart Jaune/Noir
3,6m	K033C01	K033C02
4,0m	K033D01	K033D02

Muurbevestiging met wielen Fixation murale avec roulettes	Rood/Wit Rouge/Blanc	Geel/Zwart Jaune/Noir
3,6m	K033E01	K033E02
4,0m	K033F01	K033F02

## Opvulbare hekken



- Hoge dichtheid polyethyleen
- Ledig 6kg
- Gevuld 36kg
- Polyéthylène haute densité
- Vide 6kg
- Lestée 36kg

	Geel Jaune	Rood Rouge	Zwart Noir
1000x1000mm	K0333	K0334	K0336

## Barrières à lester



- Hoge dichtheid polyethyleen
- Ledig 4,6kg
- Gevuld 12,6kg
- Polyéthylène haute densité
- Vide 4,6kg
- Lestée 12,6kg

	Rood Rouge
1500x1000mm	K0335

# AFSLUITING

# VERROUILLAGE

## Separatoren

## Séparateurs



- Opvulbaar
- Eenvoudig stapelbaar
- Gewicht ledig: 6,8kg
- Gewicht gevuld: 40kg
- Remplissable
- Facile à empiler
- Poids vide: 6,8kg
- Poids lesté: 40kg

BxHxD LxHxP	Wit Blanc	Rood Rouge	Geel Jaune	Zwart Noir
1000x500x400mm	K033H1	K033H2	K033K3	K033K4

## Hoogtebegrenzer

## Avertisseur de hauteur



- Forex 5mm
- Voorzien van 2 boringen diam. 6mm
- Niet reflecterend
- Bevestigingen niet inbegrepen
- Forex 5mm
- Prévu de 2 trous diam. 6mm
- Non-réfléchissant
- Fixations non-inclus



	Geel/Zwart Jaune/Noir	Rood/Wit Rouge/Blanc
1000x400x5mm-Recto	3784.01	3784.02
1000x400x5mm-R/V	3788.01	3788.02
1000x600x5mm-Recto	3786.01	3786.02
1000x600x5mm-R/V	3789.01	3789.02

Hoogtebegrenzer Limiteur de hauteur		
ø140 mm	1000mm	K04761
	1500mm	K04762
	2000mm	K04763



Voorzie uw zebraorden van een pictogram of extra informatie.  
Prévoyez votre panneau zèbre d'un picto ou d'information supplémentaire.

	Geel/Zwart Jaune/Noir	Rood/Wit Rouge/Blanc
1000x400x5mm-Recto	3784.MTG	3784.MTR
1000x400x5mm-R/V	3788.MTG	3788.MTR
1000x600x5mm-Recto	3786.MTG	3786.MTR
1000x600x5mm-R/V	3789.MTG	3789.MTR

Raadpleeg ons gamma bevestigingsmaterialen op pagina 180  
Consultez notre gamme de matériaux fixation à la page 180

# OPVUWBARE SIGNALISATIE

# SIGNALISATION PLIABLE

## Opvouwbare driehoeken

## Triangles pliables

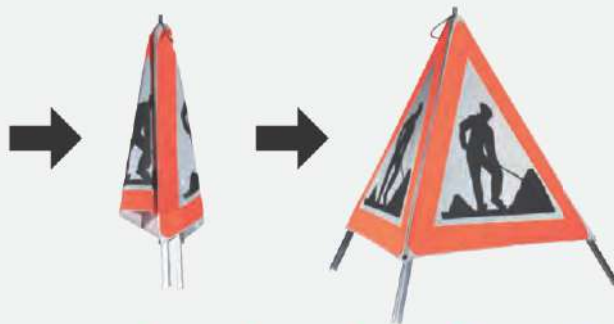

- Zeer stevige structuur
- Folie hoge kwaliteit
- 3 zijden voorzien van picto
- Geleverd met hoes
- Structure très solide
- Bache haute qualité
- Picto sur 3 côtés
- Livré avec pochette

700mm	406001	406005	406006	406002	406003	406004
700mm-Ref./Réfl.KI/ClI	404001	404005	404006	404002	404003	
900mm	407001	407005	407006	407002	407003	407004
900mm-Ref./Réfl.KI/ClI	408001	408005	408006	408002	408003	



Een opvouwbare driehoek nodig met een andere picto of eigen ontwerp? Prijzen op aanvraag.

Besoin d'un triangle de signalisation pliable avec un autre picto ou votre propre dessin? Prix sur demande.

## Gevarendriehoeken

## Triangles danger



Voor - Devant



Achter - Arrière

- Gelakt aluminium
- Niet reflecterend
- Inklapbare voet 540mm

- Aluminium laqué
- Non-réfléchissant
- Pied basculante 540mm



## Plooibare bakens

## Balises pliantes

- Polypropyleen
- 240x620mm
- Bekleefbaar opp. 180x300mm
- Recto/Verso uitvoering
- Gewicht 0,85kg

- Polypropylène
- 240x620mm
- Surface utilisable 180x300mm
- Version Recto/Verso
- Poids 0,85kg



Schrijf uw eigen boodschap, uitwisbaar

Écrivez votre propre message, effaçable



Baken - Met afwisbare laminaat  
Balise - Avec laminat effaçable

4030.ML



Marker - Zwart  
Marqueur - Noir

MARKERZ



Afbakeningsmanneltje  
Bonhomme barrière

780x1030x26mm 4051.00

## WERFBORDEN



	PP	VIN.	FOREX 3mm
400x250	1723.A7	1733.A7	
600x400			1755.A7
900x600			1756.A7



	PP
400x300	1723.C3



	PP	VIN.
400x250	1723.B3	1733.B3



	PP
400x250	1723.H5



	PP	VIN.
400x250	1723.79	1733.79



	PP	VIN.	FOREX 3mm
400x250	1723.40	1733.40	
600x400			1755.40



	PP
400x250	1723.70



	PP
400x250	1723.71



	PP	VIN.
400x250	1723.06	1733.06



	PP
400x250	1723.D6



	PP	VIN.
400x250	1723.B7	1733.B7



	PP	VIN.
400x250	1723.23	1733.23



	PP
400x250	1723.65



	PP	Dibond 3mm
600x400	1726.M2	1716.M2



	PP	FOREX 3mm	Dibond 3mm	VIN.
400x300	1723.E7			
500x350	1725.E7	1755.E7	1715.E7	1735.E7
650x500	1726.E7	1756.E7	1716.E7	
1000x650	1727.E7	1757.E7	1717.E7	



	PP	Dibond 3mm
400x300	1723.F8	
500x350	1725.F8	1715.F8
650x500	1726.F8	1716.F8
1000x650		1717.F8



	PP	FOREX 3mm	Dibond 3mm
300x420	1725.E9	1755.E9	1715.E9
500x650	1726.E9		1716.E9



	PP	FOREX 3mm	Dibond 3mm
300x420	1725.J9	1755.J9	1715.J9
500x650	1726.J9		1716.J9



Alle werfborden zijn mogelijk met eigen teksten, logo en pictogrammen naar keuze. Reeds vanaf 1 stuk verzorgen wij uw eigen ontwerp op diverse formaten en materialen.

Tous les panneaux de chantier sont possibles avec vos propres textes, logo et pictogrammes. Nous fabriquons, à partir d'une pièce votre propre lay-out sur divers matériaux en différentes dimensions.

Voorbeeld - Exemple

## Werfmarkeringen

## Traceurs de chantier

PROMARKER niet fluorescerend - 12 maanden

PROMARKER non fluorescent - 12 mois

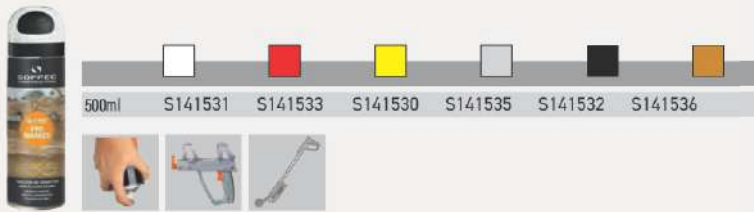

S MARK wit en fluorescerend - 6 maanden

S MARK blanc et fluorescent - 6 mois

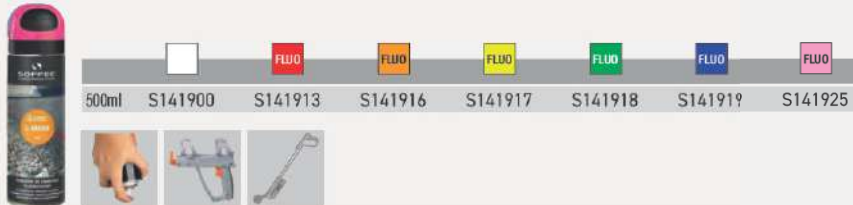

FLUO TP sterk fluorescerend - 12 maanden

FLUO TP très fluorescent - 12 mois

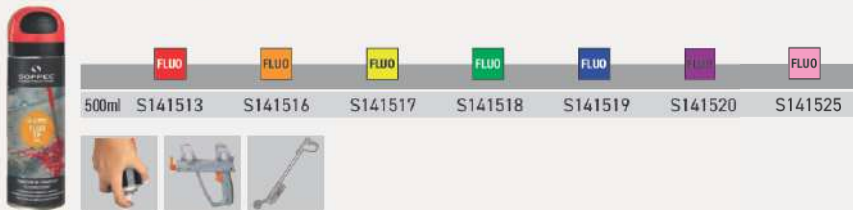

FLUO TP HYDRO sterk fluorescerend - op waterbasis - 6 maanden

FLUO TP HYDRO très fluorescent - à base d'eau - 6 mois

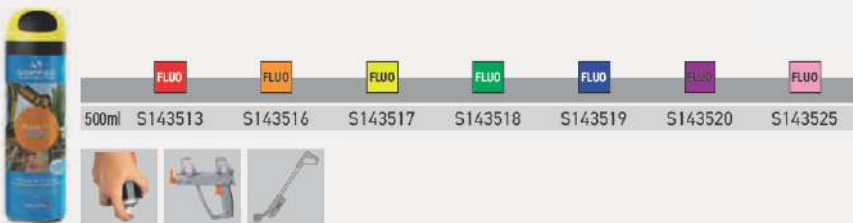

## Evenementmarkeringen

## Marquage événementiel

TEMPO MARKER kortstondig fluorescerend - op krijtbasis - 1 maand

TEMPO MARKER temporairement fluorescent - à base de craie - 1 mois

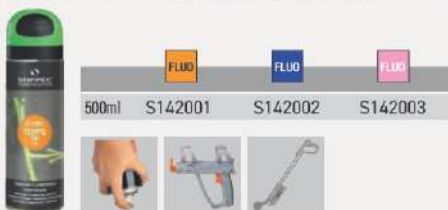

TEMPO TP wit en tijdelijk fluorescerend - 2 maanden

TEMPO TP blanc et temporairement fluorescent - 2 mois

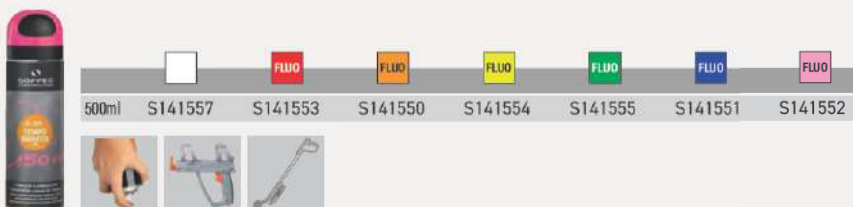



Markeerpistool  
Poignée de marquage

S432447



Markeerstang  
Canne de marquage

S441617

## Multidirectionele spuitbus 360°

## Traceur multidirectionnel 360°

IDEAL SPRAY fluorescerend - 12 maanden

IDEAL SPRAY fluorescent - 12 mois



	FLUO	FLUO	FLUO	FLUO	FLUO	FLUO	FLUO
500ml	S19004	S19005	S19002	S19001	S19006	S19003	S19000



## Tijdelijke maskering

## Masquage provisoire

MASKER SIGN grijs - weerbestendig - verwijderbaar met droge doek

MASKER SIGN gris - résistant aux intempéries - éliminer avec chiffon sec



500ml	S142107
-------	---------



## Afbakeningslinten

## Rubans de balisage

CAUTION WET PAINT CAUTION WET PAINT CAUTION WET PAINT CAUTION WET PAINT CAUTION WET PAINT CAUTION WET PAINT

75mmx300m - 70 Micron  
K8022

## Markering bosbeheer

## Traceurs forestier

STANDARD MARKER niet fluorescerend - 1 tot 2 jaar  
STANDARD MARKER non fluorescent - 1 à 2 ans

HYDRO MARK niet fluorescerend - 1 tot 2 jaar  
HYDRO MARK non fluorescent - 1 à 2 ans

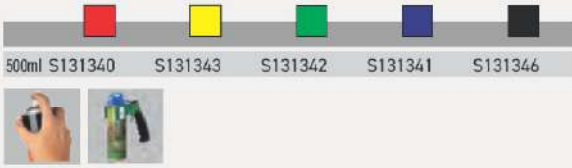

STRONG MARKER niet fluorescerend - 4 tot 6 jaar

STRONG MARKER non fluorescent - 4 à 6 ans

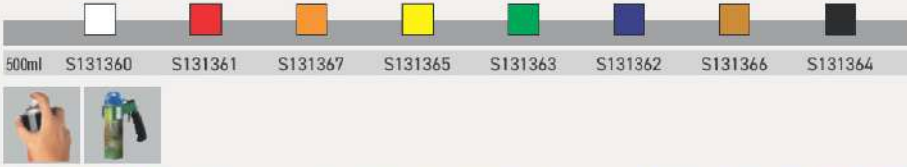

FLUO MARKER wit en fluorescerend - 1 tot 2 jaar

FLUO MARKER blanc et fluorescent - 1 à 2 ans

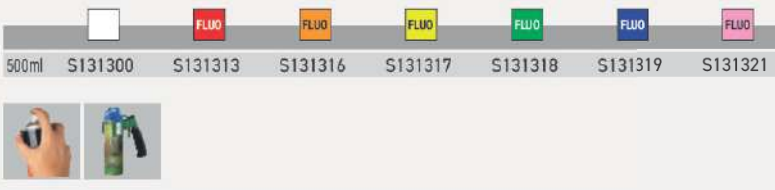

FLASH MARKER sterk fluorescerend - 12 maanden

FLASH MARKER très fluorescent - 12 mois

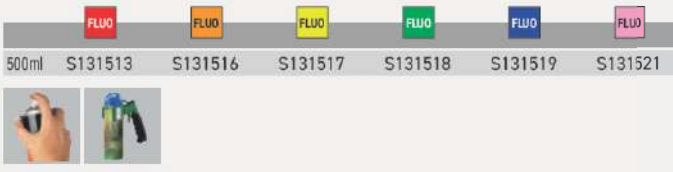

HYDRO MARK FLUO fluorescerend - 6 tot 12 maanden

HYDRO MARKER FLUO fluorescent - 6 à 12 mois





Markeerpistool  
Poignée de marquage

S432442

MARQUAGES

## Vloermarkering

## Marquage au sol

### TRACING - Buitengebruik - Standaard

### TRACING - Usage extérieur - Standard



Afhankelijk van de dikte van de lijnen en de dekking is 500ml voldoende voor 25 tot 75 meter  
En fonction de l'épaisseur des lignes et la couverture, 500ml est suffisant pour 25 à 75 mètres

500ml	S151600	S151604	S151602	S151605	S151601	S151603



MARKERINGEN

# MARKERINGEN

# MARQUAGES

## Vloermarkeringen

## Marquages au sol

### TRACING PLUS - Binnengebruik - Duurzaam

### TRACING PLUS - Usage intérieur - Durable

Afhankelijk van de dikte van de lijnen en de dekking is 750ml voldoende voor 50 tot 150 meter  
 En fonction de l'épaisseur des lignes et la couverture, 750ml est suffisant pour 50 à 150 mètres



## Markeringswagen

## Chariot de marquage



Voor Tracing en Tracing Plus  
 Lijnbreedte 50 - 120mm  
 Pour Tracing et Tracing Plus  
 Largeur ligne 50 - 120mm

SMK1005

### SJABLONEN OP PAGINA'S 263 EN 264



### POCHOIRS SUR PAGES 263 EN 264

## Veiligheidsmarkeringen

## Marquages sécurité

### Reflect Light - reflecterend - 6-12 maanden

### Reflect Light - réfléchissant - 6-12 mois



500ml S18000



### Photo Light - fotoluminescerend - DIN 67510

### Photo Light - photoluminescent - DIN 67510

Oneindige herhaling van het fotoluminescerende effect  
 Gedurende enkele uren zichtbaar zonder lichtbron (tot 8 uur)

Répétition indéfinie de l'effet photoluminescent  
 Visible plusieurs heures sans source lumineuse (jusqu'à 8 heures)



500ml S18100





S451600 S451601 S451602 S451604 S451605

## Krijt

## Craies

### MARKERINGSKRUIT

### CRAIES DE MARQUAGE

metaal - hout - papier - steen - asfalt - plastic

métal - bois - papier - pierre - asphalte - plastique



S42115 S42112 S42116 S42113 S42130

## MARKEERKOORD

## CORDEAU TRACEUR



PLASTIC / PLASTIQUE  
100 m  
1,5mm

S421515

Voor een snelle en duidelijke markering van uw bouwsites of industriële projecten.

Pour un marquage rapide et claire de vos sites de construction ou projets industriels.





Cijferhoogte Hauteur chiffres	PVC 1 mm		DIBOND 2mm		DIBOND 2mm - met opstaand randje / a bord relevé		
	50mm	75mm	100mm	150mm	200mm	300mm	500mm
0	5811.00	5812.00	5813.00	5814.00	5815.00	5817.00	5819.00
1	5811.01	5812.01	5813.01	5814.01	5815.01	5817.01	5819.01
2	5811.02	5812.02	5813.02	5814.02	5815.02	5817.02	5819.02
3	5811.03	5812.03	5813.03	5814.03	5815.03	5817.03	5819.03
4	5811.04	5812.04	5813.04	5814.04	5815.04	5817.04	5819.04
5	5811.05	5812.05	5813.05	5814.05	5815.05	5817.05	5819.05
6	5811.06	5812.06	5813.06	5814.06	5815.06	5817.06	5819.06
7	5811.07	5812.07	5813.07	5814.07	5815.07	5817.07	5819.07
8	5811.08	5812.08	5813.08	5814.08	5815.08	5817.08	5819.08
9	5811.09	5812.09	5813.09	5814.09	5815.09	5817.09	5819.09
Set 0-9	58S1.10	58S2.10	58S3.10	58S4.10	58S5.10	58S7.10	58S9.10

A	5811.0A	5812.0A	5813.0A	5814.0A	5815.0A	5817.0A	5819.0A
B	5811.0B	5812.0B	5813.0B	5814.0B	5815.0B	5817.0B	5819.0B
C	5811.0C	5812.0C	5813.0C	5814.0C	5815.0C	5817.0C	5819.0C
D	5811.0D	5812.0D	5813.0D	5814.0D	5815.0D	5817.0D	5819.0D
E	5811.0E	5812.0E	5813.0E	5814.0E	5815.0E	5817.0E	5819.0E
F	5811.0F	5812.0F	5813.0F	5814.0F	5815.0F	5817.0F	5819.0F
G	5811.0G	5812.0G	5813.0G	5814.0G	5815.0G	5817.0G	5819.0G
H	5811.0H	5812.0H	5813.0H	5814.0H	5815.0H	5817.0H	5819.0H
I	5811.0I	5812.0I	5813.0I	5814.0I	5815.0I	5817.0I	5819.0I
J	5811.0J	5812.0J	5813.0J	5814.0J	5815.0J	5817.0J	5819.0J
K	5811.0K	5812.0K	5813.0K	5814.0K	5815.0K	5817.0K	5819.0K
L	5811.0L	5812.0L	5813.0L	5814.0L	5815.0L	5817.0L	5819.0L
M	5811.0M	5812.0M	5813.0M	5814.0M	5815.0M	5817.0M	5819.0M
N	5811.0N	5812.0N	5813.0N	5814.0N	5815.0N	5817.0N	5819.0N
O	5811.0O	5812.0O	5813.0O	5814.0O	5815.0O	5817.0O	5819.0O
P	5811.0P	5812.0P	5813.0P	5814.0P	5815.0P	5817.0P	5819.0P
Q	5811.0Q	5812.0Q	5813.0Q	5814.0Q	5815.0Q	5817.0Q	5819.0Q
R	5811.0R	5812.0R	5813.0R	5814.0R	5815.0R	5817.0R	5819.0R
S	5811.0S	5812.0S	5813.0S	5814.0S	5815.0S	5817.0S	5819.0S
T	5811.0T	5812.0T	5813.0T	5814.0T	5815.0T	5817.0T	5819.0T
U	5811.0U	5812.0U	5813.0U	5814.0U	5815.0U	5817.0U	5819.0U
V	5811.0V	5812.0V	5813.0V	5814.0V	5815.0V	5817.0V	5819.0V
W	5811.0W	5812.0W	5813.0W	5814.0W	5815.0W	5817.0W	5819.0W
X	5811.0X	5812.0X	5813.0X	5814.0X	5815.0X	5817.0X	5819.0X
Y	5811.0Y	5812.0Y	5813.0Y	5814.0Y	5815.0Y	5817.0Y	5819.0Y
Z	5811.0Z	5812.0Z	5813.0Z	5814.0Z	5815.0Z	5817.0Z	5819.0Z
Set A-Z	58A1.AZ	58A2.AZ	58A3.AZ	58A4.AZ	58A5.AZ	58A7.AZ	58A9.AZ



hoogte letters / hauteur lettres 160mm



Plaat / plaque	1000x300mm	1000x300mm	700x300mm	700x300mm
DIBOND 2mm	581H.23	581H.MT	581J.25	581E.MT

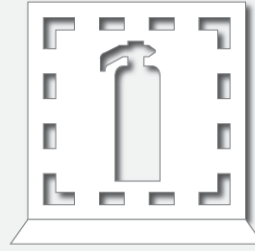

Plaat / Plaque	DIBOND 2mm	Plaat / Plaque	DIBOND 2mm	Plaat / Plaque	DIBOND 2mm	Plaat / Plaque	DIBOND 2mm
750x1000	581M.11	1000x1000	581N.14	1000x1000	581N.19	1000x1000	581N.20



Plaat / Plaque	DIBOND 2mm	Plaat / Plaque	DIBOND 2mm	Plaat / Plaque	DIBOND 2mm	Plaat / Plaque	DIBOND 2mm
1000x1000	581N.12	1000x1000	581N.13	1000x1000	581N.15	1000x1000	581N.16

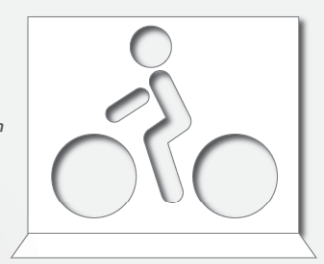
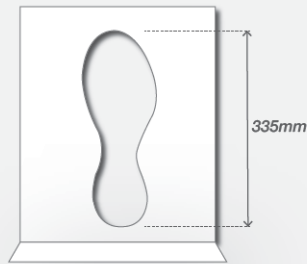
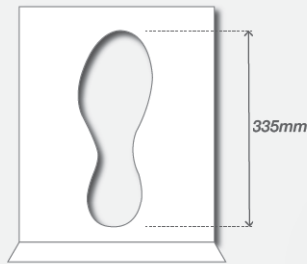
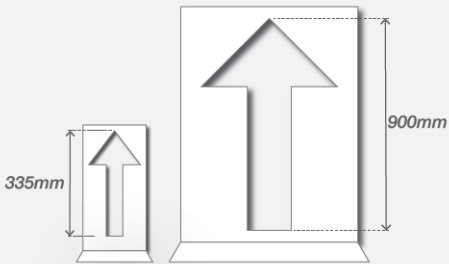

Plaat / Plaque	DIBOND 2mm	Plaat / Plaque	DIBOND 2mm	Plaat / Plaque	DIBOND 2mm	Plaat / Plaque	DIBOND 2mm
200x400	581A.15	200x400	581A.31	200x400	581A.32	1000x750	581M.18
750x1000	581M.15						

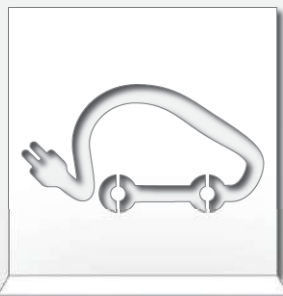

Plaat / Plaque	DIBOND 2mm	Plaat / Plaque	DIBOND 2mm	Plaat / Plaque	DIBOND 2mm
1000x1000	581N.11	1000x100	581P.33	1000x100	581Q.34



**1-ABC-123**

Wij vervaardigen een sjabloon van uw ontwerp of tekst.  
Nous produisons un pochoir de votre dessin ou texte.

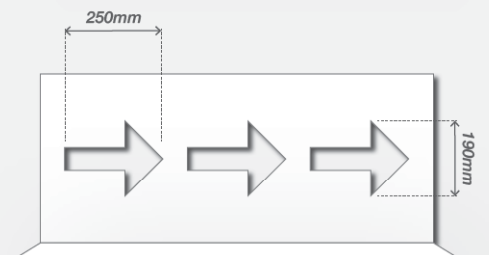

Plaat / Plaque	DIBOND 2mm
1000x300	581H.30

## Cijfers en letters op vel

## Chiffres et lettres sur feuille

Vinyl Autocollant	9x13mm 110/vel 110/feuille	14x19mm 54/vel 54/feuille	22,2x38mm 12/vel 12/feuille	21x56mm 12/vel 12/feuille	38x89mm 6/vel 6/feuille
Geel/Zwart Jaune/Noir	MP127A ↓ MP127Z	MP019A ↓ MP019Z	MP038A ↓ MP038Z	MP056A ↓ MP056Z	MP089A ↓ MP089Z
Rood/Wit Rouge/Blanc	MP127ARW ↓ MP127ZRW	MP019ARW ↓ MP019ZRW	MP038ARW ↓ MP038ZRW	MP056ARW ↓ MP056ZRW	MP089ARW ↓ MP089ZRW
Geel/Zwart Jaune/Noir	MP1270 ↓ MP1279	MP0190 ↓ MP0199	MP0380 ↓ MP0389	MP0560 ↓ MP0569	MP0890 ↓ MP0899
Rood/Wit Rouge/Blanc	MP1270RW ↓ MP1279RW	MP0190RW ↓ MP0199RW	MP0380RW ↓ MP0389RW	MP0560RW ↓ MP0569RW	MP0890RW ↓ MP0899RW



### Set van 26 vellen - Per vel identieke letters Set de 26 feuilles - Par feuille lettres identiques

Vinyl Autocollant	9x13mm 110/vel 110/feuille	14x19mm 54/vel 54/feuille	22,2x38mm 12/vel 12/feuille	21x56mm 12/vel 12/feuille	38x89mm 6/vel 6/feuille
Geel/Zwart Jaune/Noir	SET127AB	SET019AB	SET038AB	SET056AB	SET089AB
Rood/Wit Rouge/Blanc	SET127ABRW	SET019ABRW	SET038ABRW	SET056ABRW	SET089ABRW



### Set van 25 vellen Cijfer 1 tot en met 5 - Telkens 3 vellen Cijfer 6 tot en met 0 - Telkens 2 vellen

### Set de 25 feuilles Chiffre 1 jusqu'à 5 - Chaque fois 3 feuilles Chiffre 6 jusqu'à 0 - Chaque fois 2 feuilles

Vinyl Autocollant	9x13mm 110/vel 110/feuille	14x19mm 54/vel 54/feuille	22,2x38mm 12/vel 12/feuille	21x56mm 12/vel 12/feuille	38x89mm 6/vel 6/feuille
Geel/Zwart Jaune/Noir	SET127	SET019	SET038	SET056	SET089
Rood/Wit Rouge/Blanc	SET127RW	SET019RW	SET038RW	SET056RW	SET089RW

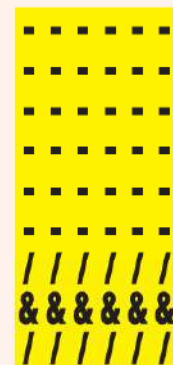
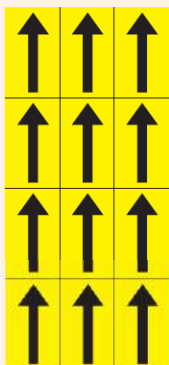

	G1/Zw Jne/Noir	Rd/Wt Rge/Blanc
9x13mm	MP127PYL	MP127PYLRW
14x19mm	MP019PYL	MP019PYLRW
22,2x38mm	MP038PYL	MP038PYLRW
21x56mm	MP056PYL	MP056PYLRW
38x89mm	MP089PYL	MP089PYLRW

	G1/Zw Jne/Noir	Rd/Wt Rge/Blanc
22,2x38mm	MP038.10	MP038.10RW

	G1/Zw Jne/Noir	Rd/Wt Rge/Blanc
14x19mm	MP019TEK	MP019TEKRW

## Teksten op transfert

## Textes sur transfert

Vinyl Vinyle	200mm	400mm	600mm	800mm
Zwart Noir	43T0A → 43T0Z	43U0A → 43U0Z	43V0A → 43V0Z	43W0A → 43W0Z
	43T00 → 43T09	43U00 → 43U09	43V00 → 43V09	43W00 → 43W09
Wit Blanc	43T1A → 43T1Z	43U1A → 43U1Z	43V1A → 43V1Z	43W1A → 43W1Z
	43T10 → 43T19	43U10 → 43U19	43V10 → 43V19	43W10 → 43W19
Geel Jaune	43T2A → 43T2Z	43U2A → 43U2Z	43V2A → 43V2Z	43W2A → 43W2Z
	43T20 → 43T29	43U20 → 43U29	43V20 → 43V29	43W20 → 43W29
Rood Rouge	43T3A → 43T3Z	43U3A → 43U3Z	43V3A → 43V3Z	43W3A → 43W3Z
	43T30 → 43T39	43U30 → 43U39	43V30 → 43V39	43W30 → 43W39
Blauw Bleu	43T4A → 43T4Z	43U4A → 43U4Z	43V4A → 43V4Z	43W4A → 43W4Z
	43T40 → 43T49	43U40 → 43U49	43V40 → 43V49	43W40 → 43W49
Grijs Gris	43T5A → 43T5Z	43U5A → 43U5Z	43V5A → 43V5Z	43W5A → 43W5Z
	43T50 → 43T59	43U50 → 43U59	43V50 → 43V59	43W50 → 43W59



Eenvoudige applicatie  
Application facile

## Uitgekaptte cijfers en letters

## Chiffres et lettres découpées

Vinyl Vinyle	50mm	70mm	100mm
Rood Rouge	913A.A → 913A.Z	9133.A → 9133.Z	913B.A → 913B.Z
	913A.00 → 913A.09	9133.00 → 9133.09	913B.00 → 913B.09
Zwart Noir	913A.AZW → 913A.ZZW	9133.AZW → 9133.ZZW	913B.AZW → 913B.ZZW
	913A.00ZW → 913A.09ZW	9133.00ZW → 9133.09ZW	913B.00ZW → 913B.09ZW
Wit Blanc	913A.AWT → 913A.ZWT	9133.AWT → 9133.ZWT	913B.AWT → 913B.ZWT
	913A.00WT → 913A.09WT	9133.00WT → 9133.09WT	913B.00WT → 913B.09WT



## Magnetische cijfers en letters

## Chiffres et lettres magnétiques

Magneet 0,6mm Magnète 0,6mm	27x60mm	38x89mm	80x160mm	120x240mm	200x200mm
Geel/Zwart Jaune/Noir	M801A ↓ M801Z	M811A ↓ M811Z	M821A ↓ M821Z	M831A ↓ M831Z	M841A ↓ M841Z
	M802A ↓ M802Z	M812A ↓ M812Z	M822A ↓ M822Z	M832A ↓ M832Z	M842A ↓ M842Z
Geel/Zwart Jaune/Noir	M8010 ↓ M8019	M8110 ↓ M8119	M8210 ↓ M8219	M8310 ↓ M8319	M8410 ↓ M8419
	M8020 ↓ M8029	M8120 ↓ M8129	M8220 ↓ M8229	M8320 ↓ M8329	M8420 ↓ M8429





Zonder bevestiging / Sans fixation				Magnetische bevestiging / Fixation magnétique (0,9mm)	
PVC	dikte/épaisseur	Wit / Blanc	Geel / Jaune	Wit / Blanc	Geel / Jaune
150x150mm	1mm	43651.MT	43652.MT	43M51.MT	43M52.MT
200x200mm	1mm	43291.MT	43292.MT	43M91.MT	43M92.MT
300x300mm	1,5mm	43631.MT	43632.MT	43M31.MT	43M32.MT
400x400mm	1,5mm	43641.MT	43642.MT	43M41.MT	43M42.MT

Tekstkleur naar keuze  
Couleur texte à choix

## 3D - 4D pictogrammen

## Pictogrammes 3D - 4D

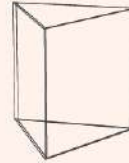

Tekstkleur naar keuze  
Couleur texte à choix

3D Zonder bevestiging / Sans fixation				Magnetische bevestiging / Fixation magnétique (0,9mm)	
PVC	dikte/épaisseur	Wit / Blanc	Geel / Jaune	Wit / Blanc	Geel / Jaune
150x200mm	1mm	43C51.MT	43C52.MT	43D51.MT	43D52.MT

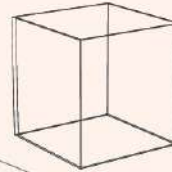

Tekstkleur naar keuze  
Couleur texte à choix

4D Zonder bevestiging / Sans fixation				Magnetische bevestiging / Fixation magnétique (0,9mm)	
PVC	dikte/épaisseur	Wit / Blanc	Geel / Jaune	Wit / Blanc	Geel / Jaune
150x150mm	1mm	43E51.MT	43E52.MT	43F51.MT	43F52.MT

## Insteekhoezen

## Pochettes

Voor formulieren die niet nat of vuil mogen worden

Pour formulaires qui doivent rester secs ou propres



A4-hoes  
PP 1,5mm drager  
of magneetstrip  
  
Pochette A4  
Fond PP 1,5mm  
ou bande magnétique

Formulier langs boven in te steken  
Formulaire à introduire par le dessus



PP		Magneetstrip / Bande magnétique	
	Wit / Blanc	Geel / Jaune	
A3 (297x420mm)			J104
A4 (210x297mm)	J100	J10A	J102
A5 (150x210mm)	J103		J101

## Barcodes - vloerlabels op maat

## Code-barres - labels de sol sur mesure

- Op maat van de klant
- Diverse materialen en formaten
- Sur mesure du client
- Divers matériaux et dimensions



# MAGAZIJNSIGNALISATIE

# SIGNALISATION MAGASIN

## Cijfers en letters groot formaat

## Chiffres et lettres grand format

Alle borden zijn voorzien van een beschermlaminaat  
Tekst / getallen op te geven bij bestelling

Tous les panneaux sont prévus d'un laminat  
Texte / chiffres à communiquer à la commande

PP 1,5mm	Wit Blanc	Geel Jaune	Blauw Bleu	Rood Rouge
210x297mm	43221.MT	43222.MT	43223.MT	43224.MT
297x420mm	432A1.MT	432A2.MT	432A3.MT	432A4.MT
300x300mm	432C1.MT	432C2.MT	432C3.MT	432C4.MT
400x400mm	43251.MT	43252.MT	43253.MT	43254.MT
600x600mm	432B1.MT	432B2.MT	432B3.MT	432B4.MT



Dibond 3mm	Wit Blanc	Geel Jaune	Blauw Bleu	Rood Rouge
210x297mm	43421.MT	43422.MT	43423.MT	43424.MT
297x420mm	434A1.MT	434A2.MT	434A3.MT	434A4.MT
300x300mm	434C1.MT	434C2.MT	434C3.MT	434C4.MT
400x400mm	43451.MT	43452.MT	43453.MT	43454.MT
600x600mm	434B1.MT	434B2.MT	434B3.MT	434B4.MT

Magneet 0,85mm Magnète 0,85mm	Wit Blanc	Geel Jaune	Blauw Bleu	Rood Rouge
210x297mm	43521.MT	43522.MT	43523.MT	43524.MT
297x420mm	435A1.MT	435A2.MT	435A3.MT	435A4.MT
300x300mm	435C1.MT	435C2.MT	435C3.MT	435C4.MT
400x400mm	43551.MT	43552.MT	43553.MT	43554.MT
600x600mm	435B1.MT	435B2.MT	435B3.MT	435B4.MT

Vinyl Vinyile	Wit Blanc	Geel Jaune	Blauw Bleu	Rood Rouge
210x297mm	43321.MT	43322.MT	43323.MT	43324.MT
297x420mm	433A1.MT	433A2.MT	433A3.MT	433A4.MT
300x300mm	433C1.MT	433C2.MT	433C3.MT	433C4.MT
400x400mm	43351.MT	43352.MT	43353.MT	43354.MT
600x600mm	433B1.MT	433B2.MT	433B3.MT	433B4.MT

## Palletmarkeringen

## Marquages palettes



Per 10 / Par 10	VIN.	Per 10 / Par 10	VIN.	Per 10 / Par 10	VIN.	Per 100 / Par 100	VIN.	Per 100 / Par 100	VIN.
200x200mm	433L.01	300x200mm	433T.01	300x300mm	433X.01	Ø 90mm	433S.01	90mm	433P.01



Bekijk ons uitgebreid Permaroute® en Permastripe® assortiment op pag. 278. Andere vormen en afmetingen zijn mogelijk op aanvraag

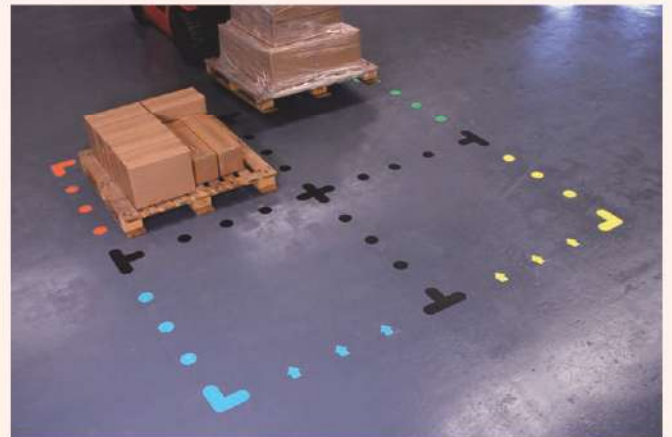

Regardez notre gamme Permaroute® et Permastripe® complète à la pag. 278. Autres formes et dimensions sont possibles sur demande

## Tijdelijke vloermarkeringen

## Marquages temporaires

Tijdelijke vloermarkeringen met een grote keuze aan sjablonen en tapes

Marquages sol temporaires avec un grand choix en pochoirs et tapes



Pag. 260-261



Pag. 263-264



Pag. 277

Volgens het 5S-principe

Basé sur la principe 5S

Standaardhaken en accessoires

Crochets et accessoires standards



T-voet 60° met tape  
B29100



Rvs ophanghaak lang  
B29001



Rvs ophanghaak enkel  
B29002



Rvs ophanghaak tussenstop  
B29003



Rvs ophanghaak dubbel  
B29004



Rvs emmerhouder  
B29005



Rvs ophangbak  
B29006



Borstelkleem  
B29007



Rvs ophanghaak extra lang  
B29008

## Op maat gemaakte ophangsystemen

De haken en ophangmodules worden door ons in 3D geprint, volledig op maat gemaakt. Deze zijn uiterst robuust en veel goedkoper dan metalen haken bijvoorbeeld.



## Ongelimeerd ontwerp

Alles is mogelijk! Van de grootte van het bord tot de bedrukking, de haken en bevestigingssysteem en de aan te leveren producten. Dankzij een full colour digitale bedrukking heeft u de vrijheid het bord volledig zelf samen te stellen qua achtergronden, tekst, schaduwen, pictogrammen, logo's, ...



## All-in-one

Wij kunnen u de borden leveren inclusief de op te hangen artikelen en dit aan een competitieve prijs. Denk hierbij bijvoorbeeld aan PBM's, LOTO-materiaal (Masterlock®), schoonmaakartikelen, magneetborden, ...

## Rangement sur mesure

Les crochets et autres supports sont produit chez nous par impression en 3D, complètement sur mesure. Les produits sont extrêmement robustes en beaucoup moins chers que des crochets en métal par exemple.

## Désign sans limite

Tout est possible! Les dimensions du panneau, l'impression, les crochets, les fixations et même les outils. Grâce à une impression digitale en full color vous avez la liberté de composer votre panneau avec fond, texte, silhouettes, pictogrammes, logos... à choix.

## Tout-en-un

Nous pouvons fournir les panneau avec les outils inclus à un prix compétitif. Il s'agit par exemple des EPI, matériel LOTO (Masterlock®), équipement de nettoyage, tableau magnétique, etc.

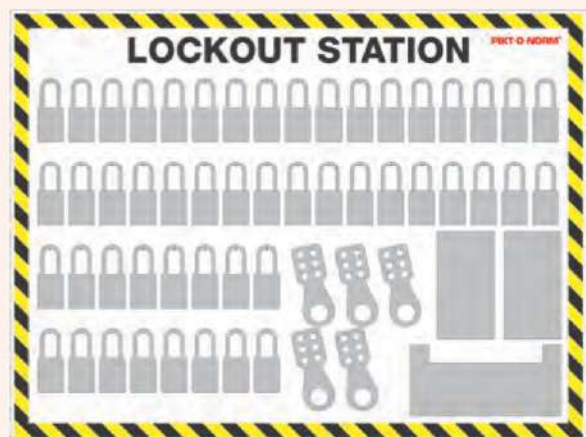

## Montage mogelijkheden

Het paneel wordt geleverd met boringen voor het op te hangen materiaal. De haken kunnen eenvoudig en snel met een inbussleutel aangebracht worden.

Voor de bevestiging van het bord kan voor boringen of rails geopteerd worden.



## Possibilités de montage

Le panneau est livré prépercé pour arranger les outils. Les crochets sont facilement et rapidement placés avec l'aide d'un clé Allen. Pour la fixation du panneau même vous avez l'option de forages ou rails.

Contacteer ons voor een offerte op maat!  
Contactez-nous pour un devis sur mesure!

## Etiketten

## Etiquettes

Voorgesneden etiketten - Per stuk - Beschrijfbaar met permanente marker  
Etiquettes précoupées - A la pièce - Inscriptible à marqueur permanent

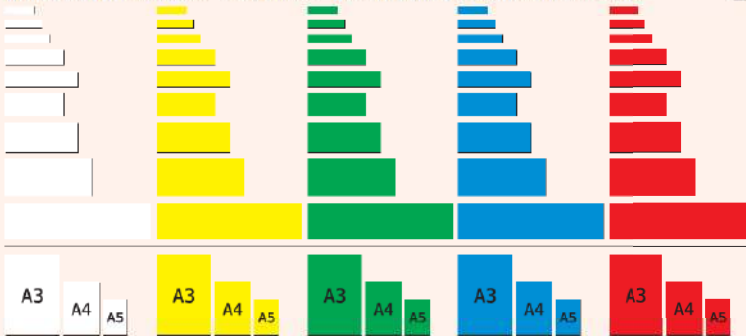

Magneet 0,6mm Magnète 0,6mm	Wit Blanc	Geel Jaune	Groen Vert	Blauw Bleu	Rood Rouge
40x10mm	M101.00	M201.01	M201.02	M201.03	M201.04
50x10mm	M102.00	M202.01	M202.02	M202.03	M202.04
60x15mm	M103.00	M203.01	M203.02	M203.03	M203.04
80x20mm	M104.00	M204.01	M204.02	M204.03	M204.04
100x20mm	M105.00	M205.01	M205.02	M205.03	M205.04
80x30mm	M106.00	M206.01	M206.02	M206.03	M206.04
100x40mm	M107.00	M207.01	M207.02	M207.03	M207.04
120x50mm	M108.00	M208.01	M208.02	M208.03	M208.04
200x50mm	M109.00	M209.01	M209.02	M209.03	M209.04
210x148mm	M10A.00	M20A.01	M20A.02	M20A.03	M20A.04
210x297mm	M10B.00	M20B.01	M20B.02	M20B.03	M20B.04
297x420mm	M10C.00	M20C.01	M20C.02	M20C.03	M20C.04

## Rollen

## Rouleaux



Magneetfolie - Per rol - Beschrijfbaar met permanente marker  
Film magnétique - Par rouleau - Inscriptible à marqueur permanent

Magneet 0,85mm Magnète 0,85mm	20mm	30mm	40mm	50mm
15mtr	M402.00	M404.00	M405.00	M406.00

## Rollen C-profiel

## Rouleaux Profile-C

Magneetfolie C-profiel - Per rol - Voor het inschuiven van eigen labels  
Film magnétique profile-C - Par rouleau - Pour glisser vos propres étiquettes

Magneet 1mm Magnète 1mm	10mm	15mm	20mm	25mm	30mm	40mm	50mm
50mtr	M300.00	M301.00	M302.00	M303.00	M304.00	M305.00	M306.00





**Mogelijkheid tot levering en personalisatie van uw inschuiflabels.**  
**Il est possible de fournir et personnaliser vos étiquettes à glisser.**



Pag 267

Om een oppervlak magnetisch te maken - Zelfklevende achterzijde - Witte voorzijde  
 Pour rendre magnétique une surface - Dos autocollante - Face blanc



	0,2mm	0,3mm	0,55mm
12mmx30mtr	M501.00		
35mmx5mtr		M503.00	
35mmx25mtr		M504.00	
210x297mm			M505.00
297x420mm			M506.00

## Magnetische symbolen

## Symboles magnétiques

Symbolen voor aanduidingen op plannen, roosters, schema's..... - Per vel.  
 Symboles pour marquages sur des plans, horaires, diagrammes..... - Par feuille.

Vorm / Forme	Aantal per vel Quantité par feuille	White	Red	Blue	Green	Yellow	Orange	Black	
□	10x10mm	90	M601.01	M601.02	M601.03	M601.04	M601.05	M601.06	M601.07
	15x15mm	36	M602.01	M602.02	M602.03	M602.04	M602.05	M602.06	M602.07
▭	25x15mm	35	M603.01	M603.02	M603.03	M603.04	M603.05	M603.06	M603.07
	20x10mm	72	M604.01	M604.02	M604.03	M604.04	M604.05	M604.06	M604.07
○	Diam.14mm	36	M605.01	M605.02	M605.03	M605.04	M605.05	M605.06	M605.07
	Diam.20mm	20	M606.01	M606.02	M606.03	M606.04	M606.05	M606.06	M606.07
➔	30x15mm	24	M607.01	M607.02	M607.03	M607.04	M607.05	M607.06	M607.07
	15x10mm	40	M608.01	M608.02	M608.03	M608.04	M608.05	M608.06	M608.07
△	16x16x16mm	91	M609.01	M609.02	M609.03	M609.04	M609.05	M609.06	M609.07



Andere maten en kleuren  
 op aanvraag.  
 Autres dimensions et  
 couleurs sur demande.

## Papieren vellen

## Feuilles papier

Papieren magnetische vellen voor inktjet en laser printer - Maak uw eigen teksten, logo's,.....magnetisch.  
 Feuilles papier magnétiques pour imprimante inktjet et laser - Magnétisez vos propres textes, logo's.....



Wit / Blanc 0,3mm	Per stuk / La pièce
A4	M701.01
A3	M702.01



Andere formaten op aanvraag.  
 Autres dimensions sur demande.

## Magnetische pictogrammen

## Pictogrammes magnétiques



Al onze pictogrammen kunnen uitgevoerd worden op magneetfolie.  
 Tous nos pictogrammes sont également livrables dans une version magnétique.

# VEILIGHEIDSZEGELS

# SCELLES DE SECURITE

## Kabelbinders

## Serre-câble



Breedte: 3,6mm  
Largeur: 3,6mm

Lengte: 200mm  
Longueur: 200mm

Transp.										
Transp.	8124.01	8124.02	8124.03	8124.04	8124.05	8124.06	8124.07	8124.08	8124.09	8124.10



Tang voor kabelbinders  
Pince pour colliers de serrage

J542

## Beschrijfbare kabelbinders

## Serre-câble écritable

Beschrijfbaar met viltstift - niet uitwisbaar  
Ecriture au marqueur fin - ineffaçable

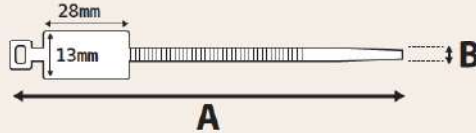

100st/pcs

A	B	Ø	Kg	
220mm	4,8mm	54mm	22,2	J53607
270mm	4,8mm	65mm	22,2	J53707
300mm	4,8mm	76mm	22,2	J53807



Marker - Zwart  
Marqueur - Noir

MARK.02

## Zegels

## Scellés

### TWIGGY SEAL

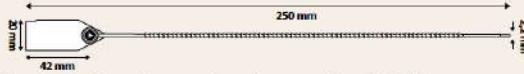

Afm.: 250mm - Diam: 2,2mm - Standaard olopende nummering - Gepersonaliseerd tot 20 kar.  
Dim.: 250mm - Diam: 2,2mm - Numérotation standard montante - Personnalisé jusqu'à 20 car.

Enkel nr./Seul no.	1000st/pcs	J50607	J50601	J50604	J50602	J50603	J50606	J50605	J50609	J50608	J50610
Geperson./Person.	5000st/pcs	JA0607	JA0601	JA0604	JA0602	JA0603	JA0606	JA0605	JA0609	JA0608	JA0610



### ADJUST SEAL

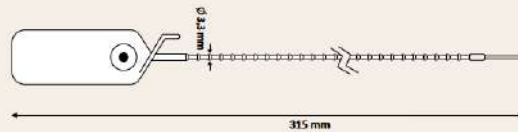

Afm.: 315mm - Diam: 3,3mm - Standaard olopende nummering - Gepersonaliseerd tot 20 kar.  
Dim.: 315mm - Diam: 3,3mm - Numérotation standard montante - Personnalisé jusqu'à 20 car.

Enkel nr./Seul no.	1000st/pcs	J50407	J50401	J50404	J50402	J50403	J50406	J50405	J50409	J50408	J50410
Geperson./Person.	5000st/pcs	JA0407	JA0401	JA0404	JA0402	JA0403	JA0406	JA0405	JA0409	JA0408	JA0410

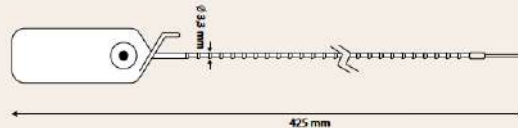

Afm.: 425mm - Diam: 3,3mm - Standaard olopende nummering - Gepersonaliseerd tot 20 kar.  
Dim.: 425mm - Diam: 3,3mm - Numérotation standard montante - Personnalisé jusqu'à 20 car.

Enkel nr./Seul no.	1000st/pcs	J50507	J50501	J50504	J50502	J50503	J50506	J50505	J50509	J50508	J50510
Geperson./Person.	5000st/pcs	JA0507	JA0501	JA0504	JA0502	JA0503	JA0506	JA0505	JA0509	JA0508	JA0510

# VEILIGHEIDSEZGELS

# SCELLES DE SECURITE

## SIMPLE SEAL

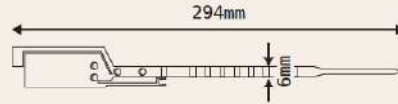

Afm.: 294mm - Breedte: 6mm - Standaard oplopende nummering - Gepersonaliseerd tot 20 kar.  
 Dim.: 294mm - Largeur: 6mm - Numérotation standard montante - Personnalisé jusqu'à 20 car.

Enkel nr./Seul no. 1000st/pcs	J50307	J50301	J50304	J50302	J50303	J50306	J50308
Geperson./Person. 5000st/pcs	JA0307	JA0301	JA0304	JA0302	JA0303	JA0306	JA0308



## LONG SEAL

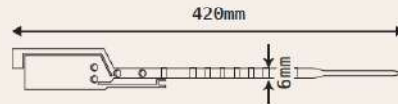

Afm.: 420mm - Breedte: 6mm - Standaard oplopende nummering - Gepersonaliseerd tot 20 kar.  
 Dim.: 420mm - Largeur: 6mm - Numérotation standard montante - Personnalisé jusqu'à 20 car.

Enkel nr./Seul no. 1000st/pcs	J51207	J51201	J51204	J51202	J51203	J51206	J51208
Geperson./Person. 5000st/pcs	JA1207	JA1201	JA1204	JA1202	JA1203	JA1206	JA1208



## JUPITER SEAL

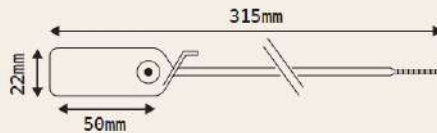

Afm.: 315mm - Diam: 2mm - Standaard oplopende nummering - Gepersonaliseerd tot 20 kar.  
 Dim.: 315mm - Diam: 2mm - Numérotation standard montante - Personnalisé jusqu'à 20 car.

Enkel nr./Seul no. 1000st/pcs	J51907	J51901	J51904	J51902	J51903	J51906	J51905	J51908
Geperson./Person. 5000st/pcs	JA1907	JA1901	JA1904	JA1902	JA1903	JA1906	JA1905	JA1908



## LABELRINGSEAL

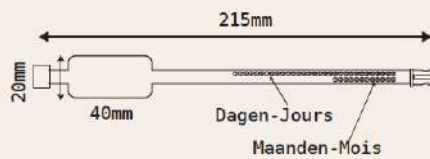

Afm.: 215mm - Breedte: 7mm - Standaard oplopende nummering - Gepersonaliseerd tot 20 kar.  
 Dim.: 215mm - Largeur: 7mm - Numérotation standard montante - Personnalisé jusqu'à 20 car.

Enkel nr./Seul no. 1000st/pcs	J50707	J50701	J50704	J50702	J50703	J50706	J50708
Geperson./Person. 5000st/pcs	JA0707	JA0701	JA0704	JA0702	JA0703	JA0706	JA0708

Afm.: 260mm - Breedte: 7mm - Standaard oplopende nummering - Gepersonaliseerd tot 20 kar.  
 Dim.: 260mm - Largeur: 7mm - Numérotation standard montante - Personnalisé jusqu'à 20 car.

Enkel nr./Seul no. 1000st/pcs	J51707	J51701	J51704	J51702	J51703	J51706	J51708
Geperson./Person. 5000st/pcs	JA1707	JA1701	JA1704	JA1702	JA1703	JA1706	JA1708

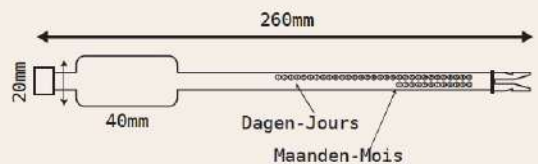

# VEILIGHEIDSZEGELS

# SCELLES DE SECURITE

## CABLE SEAL

Afm.: 180mm - Diam: 1,5mm - Standaard olopende nummering - Gepersonaliseerd tot 20 kar.  
 Dim.: 180mm - Diam: 1,5mm - Numérotation standard montante - Personnalisé jusqu'à 20 car.

					
Enkel nr./Seul no. 500st/pcs	J50201	J50204	J50202	J50203	J50208
Geperson./Person. 1000st/pcs	JA0201	JA0204	JA0202	JA0203	JA0208





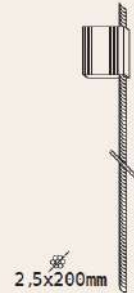

Afm.: 200mm - Diam: 2,5mm - Standaard olopende nummering - Gepersonaliseerd tot 20 kar.  
 Dim.: 200mm - Diam: 2,5mm - Numérotation standard montante - Personnalisé jusqu'à 20 car.

					
Enkel nr./Seul no. 500st/pcs	J51301	J51304	J51302	J51303	J51308
Geperson./Person. 1000st/pcs	JA1301	JA1304	JA1302	JA1303	JA1308





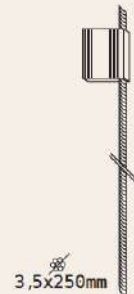

Afm.: 250mm - Diam: 3,5mm - Standaard olopende nummering - Gepersonaliseerd tot 20 kar.  
 Dim.: 250mm - Diam: 3,5mm - Numérotation standard montante - Personnalisé jusqu'à 20 car.

					
Enkel nr./Seul no. 500st/pcs	J51501	J51504	J51502	J51503	J51508
Geperson./Person. 1000st/pcs	JA1501	JA1504	JA1502	JA1503	JA1508



Afm.: 250mm - Diam: 5mm - Standaard olopende nummering - Gepersonaliseerd tot 20 kar.  
 Dim.: 250mm - Diam: 5mm - Numérotation standard montante - Personnalisé jusqu'à 20 car.

					
Enkel nr./Seul no. 500st/pcs	J51601	J51604	J51602	J51603	J51608
Geperson./Person. 1000st/pcs	JA1601	JA1604	JA1602	JA1603	JA1608



## BALLOONSEAL



Afm.: 215mm - Breedte: 9,5mm - Standaard olopende nummering - Gepersonaliseerd tot 16 kar.  
 Dim.: 215mm - Largeur: 9,5mm - Numérotation standard montante - Personnalisé jusqu'à 16 car.

Enkel nr./Seul no. 1000st/pcs	J50811
Geperson./Person. 1000st/pcs	JA0811



# VEILIGHEIDSZEGELS

# SCELLES DE SECURITE

## NEW FORKSEAL

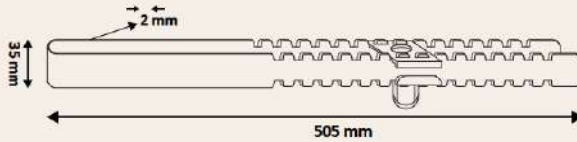

Afm.: 505mm - Gepersonaliseerd tot 20 kar.  
Dim.: 505mm - Personnalisé jusqu'à 20 car.

Enkel nr./Seul no. 25st/pcs	J51811
Geperson./Person. 500st/pcs	JA1811

## TWISTSEAL

Afm. draad: 150mm - Standaard olopende nummering - Gepersonaliseerd tot 20 kar.  
Dim. câble: 150mm - Numérotation standard montante - Personnalisé jusqu'à 20 car.

Enkel nr./Seul no. 1000st/pcs	J52107	J52101	J52104	J52102	J52103	J52106	J52110
Geperson./Person. 5000st/pcs	JA2107	JA2101	JA2104	JA2102	JA2103	JA2106	JA2110

## NEPTUNE SEAL

Standaard olopende nummering - Gepersonaliseerd tot 20 kar.  
Numérotation standard montante - Personnalisé jusqu'à 20 car.

Dubbel nr./No. double 250st/pcs	J51007	J51001
Geperson./Person. 1000st/pcs	JA0907	JA0901

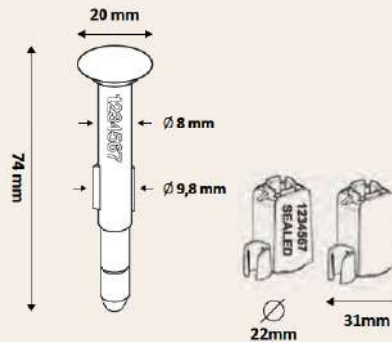

## PLOMBEX

Diam.: 9mm  
Diam.: 9mm

1000st/pcs	J52007	J52001	J52004	J52002	J52003	J52005	J52008



## GEPAARDE VERZINKTE VERZEGELDRAAD FIL PERLE GALVANISE A PLOMBER



LOODTANG 10mm  
PINCE A PLOMBER 10mm

Bundel/Paquet 200mm	1000st/pcs	J533
Bundel/Paquet 300mm	1000st/pcs	J534
Bundel/Paquet 400mm	1000st/pcs	J535
Bobijn/Bobine 200gr		J532
Bobijn/Bobine 1kg		J531

Neutraal/Neutre 1st/pc	J530
Geperson./Person. 1st/pc	JA30



## Tapes & markeringsbanden

## Rubans adhésifs & bandes de marquages

### Gekleurde tapes - Rol van 33m

### Rubans colorés - Rouleau de 33m

Breedte/Largeur										
25mm	TA1001	TA1002	TA1003	TA1004	TA1005	TA1006	TA1007	TA1008	TA1009	TA1010
50mm	TA2001	TA2002	TA2003	TA2004	TA2005	TA2006	TA2007	TA2008	TA2009	TA2010
75mm	TA2101	TA2102	TA2103	TA2104	TA2105	TA2106	TA2107	TA2108	TA2109	TA2110
100mm	TA4001	TA4002	TA4003	TA4004	TA4005	TA4006	TA4007	TA4008	TA4009	TA4010

### Band van 1000mm

### Bande de 1000mm

Breedte/Largeur				
50mm	3730.01L	3730.01R	3730.02L	3730.02R
100mm	3731.01L	3731.01R	3731.02L	3731.02R
250mm	3732.01L	3732.01R	3732.02L	3732.02R

### Reflecterend - Band van 1000mm

### Réfléchissants - Bande de 1000mm

Breedte/Largeur				
50mm	37R0.01L	37R0.01R	37R0.02L	37R0.02R
100mm	37R1.01L	37R1.01R	37R1.02L	37R1.02R
250mm	37R2.01L	37R2.01R	37R2.02L	37R2.02R
300mm	37R3.01L	37R3.01R	37R3.02L	37R3.02R
400mm	37R4.01L	37R4.01R	37R4.02L	37R4.02R
500mm	37R5.01L	37R5.01R	37R5.02L	37R5.02R

### Reflecterend Klasse I - Rol van 10m

### Réfléchissant Classe I - Rouleau de 10m

Breedte/Largeur							
25mm	TA1901	TA1902	TA1A03	TA1A04	TA1A05	TA1A06	TA1A08
50mm	TA1601	TA1602	TA1403	TA1404	TA1405	TA1406	TA1408
100mm	TA1701	TA1702	TA1503	TA1504	TA1505	TA1506	TA1508
150mm	TA1801	TA1802	TA1803	TA1804	TA1805	TA1806	TA1808
200mm	TA1C01	TA1C02	TA1D03	TA1D04	TA1D05	TA1D06	TA1D08

### Reflecterend Klasse I - Band van 1000mm

### Réfléchissant Classe I - Bande de 1000mm

Breedte/Largeur				
20mm	TAR2.01	TAR2.02	TAR2.03	TAR2.04
40mm	TAR4.01	TAR4.02	TAR4.03	TAR4.04
60mm	TAR6.01	TAR6.02	TAR6.03	TAR6.04

### Retroreflecterend Klasse I - Rol van 45,7m

### Retrorefléchissant Classe I - Roule de 45,7m

Breedte/Largeur							
50mm	TA5003	TA5004	TA5005	TA5006	TA5007	TA5008	TA5101

### Fotoluminescerend - Rol van 10m

### Photoluminescent - Rouleau de 10m

Breedte/Largeur			
20mm	SG030		
40mm	SG031		
50mm	SG036	SG033B	SG133
80mm	SG032		



### Gekleurde voet-/handafdrukken - per paar

### Empreintes de pieds et mains colorées - par paire

	Vin. 300mm		Vin. 200mm	
		SV3301		SV3311
		SV3302		SV3312
		SV3303		SV3313
		SV3304		SV3314
		SV3305		SV3315

## Vloermarkering niet-permanent

## Marquage au sol non permanent

### Gekleurde tapes - Rol van 33m

### Rubans colorés - Rouleau de 33m

Breedte/Largeur										
25mm	TA1201	TA1202	TA1207		TA1203	TA1204	TA1205	TA1206	TA1208	TA1209
50mm	TA1301	TA1302	TA1307	TA1310	TA1303	TA1304	TA1305	TA1306	TA1308	TA1309
75mm	TA1101	TA1102	TA1107		TA1103	TA1104	TA1105	TA1106	TA1108	TA1109
100mm	TA2201	TA2202	TA2207		TA2203	TA2204	TA2205	TA2206	TA2208	TA2209



Tape applicator  
Applicateur rubans  
6801

## Vloermarkering permanent

## Marquage au sol permanent

### PERMAROUTE® & PERMASTRIBE®

Een compleet gamma voor indoor-belijningen en magazijnaanduidingen. De snelle applicatie staat toe om op zeer korte tijd nieuwe inrichtingen te markeren. De hoge kleefkracht en het stevige materiaal, 1mm dikte bij de PermaStripe® en 0,7mm dikte bij de PermaRoute®, zorgen voor een zeer hoogwaardig product.

### PERMAROUTE® & PERMASTRIBE®

Une gamme complète pour le marquage de lignes à l'intérieur et indications pour magasins. L'application rapide permet de marquer à court terme de nouveaux aménagements. L'adhésif solide à haute résistance, 1mm d'épaisseur pour le PermaStripe® et 0,7mm pour le PermaRoute®, donne un produit de très haute qualité.

#### PERMAROUTE® - Rol van 30m

Breedte/Largeur								FLUO		
25mm	TR0001	TR0003	TR0004	TR0005	TR0006	TR0008	TR0009	TR0010	TR0002	TR0007
50mm	TR1001	TR1003	TR1004	TR1005	TR1006	TR1008	TR1009	TR1010	TR2002	TR2007
75mm	TR1101	TR1103	TR1104	TR1105	TR1106	TR1108	TR1109	TR1110	TR2102	TR2107
100mm	TR1201	TR1203	TR1204	TR1205	TR1206	TR1208	TR1209	TR1210	TR2202	TR2207

#### PERMAROUTE® - Roule de 30m

#### PERMAROUTE® - Hoek van 90°

Breedte/Largeur								FLUO
50mm	TH1001	TH1003	TH1004	TH1005	TH1006	TH1008	TH1009	TH1010
75mm	TH1101	TH1103	TH1104	TH1105	TH1106	TH1108	TH1109	TH1110
100mm	TH1201	TH1203	TH1204	TH1205	TH1206	TH1208	TH1209	TH1210

#### PERMAROUTE® - Coin 90°

#### PERMASTRIBE® - Rol van 30m

Breedte/Largeur								FLUO		
50mm	TS1001	TS1003	TS1004	TS1005	TS1006	TS1008	TS1009	TS1010	TS2002	TS2007
75mm	TS1101	TS1103	TS1104	TS1105	TS1106	TS1108	TS1109	TS1110	TS2102	TS2107
100mm	TS1201	TS1203	TS1204	TS1205	TS1206	TS1208	TS1209	TS1210	TS2202	TS2207

#### PERMASTRIBE® - Roule de 30m

#### PERMASTRIBE® - Hoek van 90°

Breedte/Largeur								FLUO
50mm	TJ1001	TJ1003	TJ1004	TJ1005	TJ1006	TJ1008	TJ1009	TJ1010
75mm	TJ1101	TJ1103	TJ1104	TJ1105	TJ1106	TJ1108	TJ1109	TJ1110
100mm	TJ1201	TJ1203	TJ1204	TJ1205	TJ1206	TJ1208	TJ1209	TJ1210

#### PERMASTRIBE® - Coin 90°

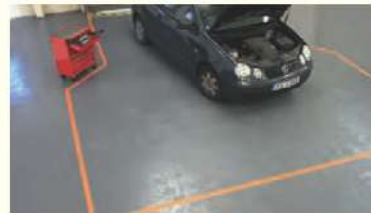

Applicator voor / Appicateur pour PermaStripe®  
6802



Roller / Rouleur  
J205

Verzeker u van een perfecte voorbereiding en afwerking.  
Assurez-vous d'une préparation et finition parfaite.

	1000ml	500ml	140ml
Cleaner / Nettoyant	2m <sup>2</sup>	TA912	
Primer / Apprêt	5m <sup>2</sup>		
Primer / Apprêt	2,5m <sup>2</sup>	TA910	TA913
Edge fix tube / Tube fixation bord	35m		TA911



Mogelijkheid tot plaatsen van uw belijningsprojecten.  
Possibilité de placement de vos projets de marquage de lignes.













# TAPES

# BANDES

## Palletmarkeringen







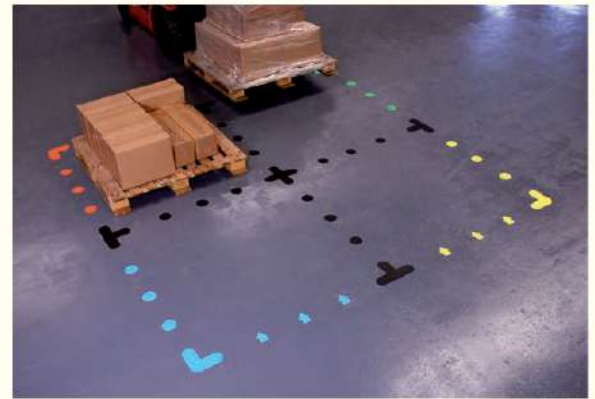



## Marquages palettes

### PERMAROUTE®

Stuk Pièce					
	90mm	90mm	300x300mm	300x200mm	200x200mm
	TL1004	TK1004	TN1004	TQ1004	TU1004
	TL1009	TK1009	TN1009	TQ1009	TU1009
	TL1008	TK1008	TN1008	TQ1008	TU1008
	TL1003	TK1003	TN1003	TQ1003	TU1003
	TL1005	TK1005	TN1005	TQ1005	TU1005
	TL1006	TK1006	TN1006	TQ1006	TU1006
	TL1001	TK1001	TN1001	TQ1001	TU1001
	TL1010	TK1010	TN1010	TQ1010	TU1010

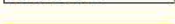
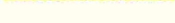

### PERMASTRIFE®

Stuk Pièce					
	90mm	90mm	300x300mm	300x200mm	200x200mm
	TV1004	TW1004	TX1004	TY1004	TZ1004
	TV1009	TW1009	TX1009	TY1009	TZ1009
	TV1008	TW1008	TX1008	TY1008	TZ1008
	TV1003	TW1003	TX1003	TY1003	TZ1003
	TV1005	TW1005	TX1005	TY1005	TZ1005
	TV1006	TW1006	TX1006	TY1006	TZ1006
	TV1001	TW1001	TX1001	TY1001	TZ1001
	TV1010	TW1010	TX1010	TY1010	TZ1010















Andere vormen en afmetingen op aanvraag.  
Autres formes et dimensions sur demande.

## Magazijnaanduidingen

## Indications magasins

### PERMAROUTE®

Stuk Pièce			Paar Paire		
	345x540mm	560x525mm		90x240mm	57x104mm
	TD1004	TI1004		TO1004	TT1004
	TD1009	TI1009		TO1009	TT1009
	TD1008	TI1008		TO1008	TT1008
	TD1003	TI1003		TO1003	TT1003
	TD1005	TI1005		TO1005	TT1005
	TD1006	TI1006		TO1006	TT1006
	TD1001	TI1001		TO1001	TT1001
	TD1010	TI1010		TO1010	TT1010



## Antislip tapes

## Bandes antidérapantes

### STANDAARD - Rol van 18,3m

### STANDARD - Rouleau de 18,3m

Breedte/Largeur	■	■	■	■	■	■	■	■	■	FLUO	TRSP	■	■
25mm	TA7001	TA7002	TA7003	TA7004	TA7005	TA7006	TA7007	TA7008	TA7009	TA7010	TA7011	TA7012	
50mm	TA7101	TA7102	TA7103	TA7104	TA7105	TA7106	TA7107	TA7108	TA7109	TA7110	TA7111	TA7112	
75mm	TA7201	TA7202	TA7203	TA7204	TA7205	TA7206	TA7207	TA7208	TA7209	TA7210	TA7211	TA7212	
100mm	TA7301	TA7302	TA7303	TA7304	TA7305	TA7306	TA7307	TA7308	TA7309	TA7310	TA7311	TA7312	



### STRONG - Rol van 18,3m

Verhoogde antislip waarde met groffe korrel

### STRONG - Rouleau de 18,3m

Valeur antidérapante augmentée à grain rugueux

Breedte/Largeur	■	■	■	■
25mm	TA8001	TA8002	TA8003	TA8004
50mm	TA8101	TA8102	TA8103	TA8104
75mm	TA8201	TA8202	TA8203	TA8204
100mm	TA8301	TA8302	TA8303	TA8304



Alle tapes hebben een identieke sterke lijmlaag.  
De STRONG-versie heeft een groffere korrel en de SUPERSTRONG-versie een extra groffe korrel.

Toutes les bandes ont un adhésif puissant identique.  
La version STRONG a un grain plus rugueux et la version SUPERSTRONG un grain extra rugueux.

### SUPERSTRONG - Rol van 18,3m

Zéér hoge antislip waarde met extra groffe korrel

### SUPERSTRONG - Rouleau de 18,3m

Valeur antidérapante très élevée à grain extra rugueux

Breedte/Largeur	■	■
25mm	TAS001	TAS005
50mm	TAS101	TAS105
75mm	TAS201	TAS205
100mm	TAS301	TAS305



### FOTOLUMINESCEREND

### PHOTOLUMINESCENTE

Type (Lengte/longueur)	■	■	■	■	■
Breedte/Largeur	STANDARD (18,3m)		SUPER (15m)		PREMIUM (15m)
25mm	TAP001	TAP002			
50mm	TAP101	TAP102	TAP103	TAP111	TAP121
75mm	TAP201	TAP202			
100mm	TAP301	TAP302			



### SOFT GRIP - Rol van 18,3m

Antislip voor gebruik op ladders, hendels, leuningen. Tevens toepasbaar als antislip op boten, in zwembaden, douches, enz... is iets minder grof dan de AquaSafe.

### SOFT GRIP - Rouleau de 18,3m

Antidérapant pour usage sur échelles, manivelles, rampes. Egalement à utiliser comme antidérapant sur des bateaux, dans des piscines, douches, etc... à grain moins rugueux que l'AquaSafe.

STANDAARD / STANDARD	■	■	STRONG	■
Breedte/Largeur	■	■	■	■
25mm	TAE001	TAE002	TAF001	TAF002
50mm	TAE101	TAE102	TAF101	TAF102
75mm	TAE201	TAE202	TAF201	TAF202
100mm	TAE301	TAE302	TAF301	TAF302

Verhoogde antislip waarde  
Valeur antidérapante augmentée



### CUSHION GRIP - Rol van 18,3m

Antislip voor gebruik op hendels, leuningen. Heeft een comfortabeler raakgevoel dan de Soft grip.

### CUSHION GRIP - Rouleau de 18,3m

Antidérapant pour usage sur manivelles, rampes. Touche plus confortable que le Soft grip.

Breedte/Largeur	■
25mm	TAC001
50mm	TAC101
75mm	TAC201
100mm	TAC301



### MATERIAL GRIP - Rol van 18,3m

Ideaal voor het op plaats houden van toestellen, laptops, enz...

### MATERIAL GRIP - Rouleau de 18,3m

Idéal pour le maintien en place d'instruments, ordinateurs portables, etc...

Breedte/Largeur	■	■
25mm	TAM001	TAN002
50mm	TAM101	TAN102
75mm	TAM201	TAN202
100mm	TAM301	TAN302



### SAFETY GRIP - Rol van 18,3m

Gebruik op metalen roosters, traanplaten, metalen trappen, brandladders, enz... Kan op zijn plaats gehamerd worden.

### SAFETY GRIP - Rouleau de 18,3m

Usage sur grilles, escaliers-métalliques, tôles gaufrées, larmées, etc... Peut être martelé en place.

Breedte/Largeur	■	■	■
25mm	TAH001	TAH002	TAH003
50mm	TAH101	TAH102	TAH103
75mm	TAH201	TAH202	TAH203



Hamer in rubber / Marteau en caoutchouc  
J201

## Antislip tegels

## Dalles antidérapantes

### STANDAARD

### STANDARD

Afm./Dim.													
140x40	TC11.01	TC11.02	TC11.03	TC11.04	TC11.05	TC11.06	TC11.07	TC11.08	TC11.09	TC11.10	TC11.11	TC11.12	TC11.13
610x150	TC12.01	TC12.02	TC12.03	TC12.04	TC12.05	TC12.06	TC12.07	TC12.08	TC12.09	TC12.10	TC12.11	TC12.12	TC12.13
ø25mm	TC13.01	TC13.02	TC13.03	TC13.04	TC13.05	TC13.06	TC13.07	TC13.08	TC13.09	TC13.10	TC13.11	TC13.12	TC13.13
ø50mm	TC14.01	TC14.02	TC14.03	TC14.04	TC14.05	TC14.06	TC14.07	TC14.08	TC14.09	TC14.10	TC14.11	TC14.12	TC14.13
ø75mm	TC15.01	TC15.02	TC15.03	TC15.04	TC15.05	TC15.06	TC15.07	TC15.08	TC15.09	TC15.10	TC15.11	TC15.12	TC15.13
ø100mm	TC16.01	TC16.02	TC16.03	TC16.04	TC16.05	TC16.06	TC16.07	TC16.08	TC16.09	TC16.10	TC16.11	TC16.12	TC16.13



Standaard / Standard

### FOTOLUM + REFL. / PHOTOLUM. + REFL.

Met fotoluminescerende en reflecterende strip  
A bande photoluminescente et réfléchissante



Afm./Dim.	
610x150	TC18.01

### REFLECTERENDE STRIP / BANDE REFLECH.

Met reflecterende strip  
A bande réfléchissante



Afm./Dim.	
140x40	TC17.01

### WAARSCHUWING / AVERTISEMENT

Andere teksten mogelijk op aanvraag.  
Autres textes possibles sur demande.



Afm./Dim.		
610x150	TC19.01	TC19.02

### STRONG



Afm./Dim.			
610x150	TC22.01	TC22.02	TC22.05

### SUPERSTRONG



Extra groffe korrel  
Grain extra rugueux

Afm./Dim.	
610x150	TC32.01



Elke toepassing is anders, gebruik de gepaste tape. Zorg altijd voor een prope, vetvrije en droge ondergrond. Chaque application est différente. Utilisez l'antislip adéquat. La surface doit être propre, sèche et sans matières grasses.

## Antislip voeten

## Pieds antislip

### STANDAARD

### STANDARD



MOD. A



MOD. B



MOD. C

Per paar / La paire													
Mod. A (240mm)	TC41.01	TC41.02	TC41.03	TC41.04	TC41.05	TC41.06	TC41.07	TC41.08	TC41.09	TC41.10	TC41.11	TC41.12	TC41.13
Mod. B (280mm)	TC42.01	TC42.02	TC42.03	TC42.04	TC42.05	TC42.06	TC42.07	TC42.08	TC42.09	TC42.10	TC42.11	TC42.12	TC42.13
Mod. C (104mm)	TC43.01	TC43.02	TC43.03	TC43.04	TC43.05	TC43.06	TC43.07	TC43.08	TC43.09	TC43.10	TC43.11	TC43.12	TC43.13



Tevens beschikbaar in AquaSafe en Permaroute®.  
Egalement disponible en AquaSafe et Permaroute®.

## Tapes - Chemicaliën bestendig

## Bandes - Résistant aux produits chimiques

STANDARD - Rol van 18,3m

STANDARD - Rouleau de 18,3m

Breedte/Largeur	
25mm	TAV001
50mm	TAV101
75mm	TAV201
100mm	TAV301

STRONG - Rol van 18,3m

Verhoogde antislip waarde met groffe korrel

Breedte/Largeur	
25mm	TAW001
50mm	TAW101
75mm	TAW201
100mm	TAW301

SUPERSTRONG - Rol van 18,3m

Zéér hoge antislip waarde met extra groffe korrel

Breedte/Largeur	
25mm	TAX001
50mm	TAX101
75mm	TAX201
100mm	TAX301



STRONG - Rouleau de 18,3m  
Valeur antidérapante augmentée à grain rugueux

SUPERSTRONG - Rouleau de 18,3m  
Valeur antidérapante très élevée à grain extra rugueux

## Tapes - Marine

## Bandes - Marine

STANDARD - Rol van 18,3m

Voor gebruik in de scheepvaart  
Zoutbestendig

STANDARD - Rouleau de 18,3m

Pour les applications marines  
Matériel résistant au sel

Breedte/Largeur				
25mm	TAZ001	TAZ003	TAZ004	TAZ006
50mm	TAZ101	TAZ103	TAZ104	TAZ106
75mm	TAZ201	TAZ203	TAZ204	TAZ206
100mm	TAZ301	TAZ303	TAZ304	TAZ306



### VERPAKKINGSTAPE

Vanaf 72 rollen met eigen tekst en/of logo  
Zelfklevende PP - 48mmx66meter / Rol



### RUBAN ADHÉSIF D'EMBALLAGE

A partir de 72 rouleaux avec votre propre texte et/ou logo  
PP adhésif - 48mmx66mètres / Rouleau

## AquaSafe - Tapes

## Bandes - AquaSafe

Voor gebruik in vochtige ruimtes zoals:  
douches, zwembaden, enz...

Pour usage dans des endroits humides comme:  
douches, piscines, etc...

STANDAARD - Rol van 18,3m

STANDARD - Rouleau de 18,3m

Breedte/Largeur	■	□	■	■	TRSP
25mm	TAA001	TAA002	TAA003	TAA004	TAA005
50mm	TAA101	TAA102	TAA103	TAA104	TAA105
75mm	TAA201	TAA202	TAA203	TAA204	TAA205
100mm	TAA301	TAA302	TAA303	TAA304	TAA305

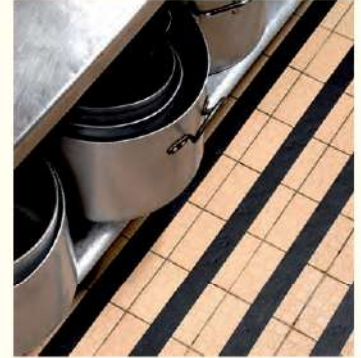

## AquaSafe - Tegels

## Dalles - AquaSafe

STANDAARD

STANDARD

Afm./Dim.	■	□	TRSP	■	■
140x140	TF11.01	TF11.03	TF11.04	TF11.07	TF11.08
610x150	TF12.01	TF12.03	TF12.04	TF12.07	TF12.08
ø25mm	TF13.01	TF13.03	TF13.04		
ø50mm	TF14.01	TF14.03	TF14.04		
ø75mm	TF15.01	TF15.03	TF15.04		
ø100mm	TF16.01	TF16.03	TF16.04		



## AquaSafe - Voeten

## Pieds - AquaSafe

Per paar / La paire	■	□	TRSP
Mod. A (240mm)	TF41.01	TF41.03	TF41.04
Mod. B (280mm)	TF42.01	TF42.03	TF42.04
Mod. C (104mm)	TF43.01	TF43.03	TF43.04

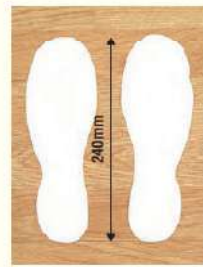

MOD. A



MOD. B



MOD. C

## Aluminium bodemplaat

## Plaque aluminium

Aluminium platen voorzien van een standaard antisliptape. Voor gebruik op plaatsen die geen tape toelaten. Te bevestigen met vijzen, gaten van Ø 6mm, vijzen niet inbegrepen.  
Plaques en aluminium prévus d'un antidérapant standard. Pour utilisation à des endroits qui ne permettent pas de bande. A fixer avec vis, Ø 6mm, vis non-incluses.



635x115mm	TG1601	TG1602
-----------	--------	--------

635x120x45mm	TG1701	TG1702
--------------	--------	--------



Voor oneffen ondergronden  
Pour surfaces irrégulières

## Afbakeningslinten

## Rubans de balisage

### STANDAARD

### STANDARD

Rol van/Rouleau de 500m	Breedte/Largeur de 70mm
STANDARD 30 Micron	K1001
STANDARD 30 Micron	K1002
Rol van/Rouleau de 100m	Breedte/Largeur de 70mm
MAXITAPE 100 Micron	K1006
MAXITAPE 100 Micron	K1009
Rol van/Rouleau de 25m	Breedte/Largeur de 20mm
Oranje afbakeningslint	K1010

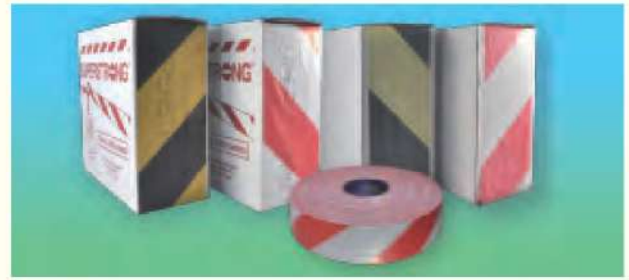

### NOODGEVAL-LINTEN

75mmx300m - 70 Micron

### RUBANS CAS D'URGENCE

75mmx300m - 70 Micron

	K8003
	K8004
	K8005
	K8006
	K8007
	K8008
	K8009
	K8010
	K8011
	K8023
	K8021

	K8020
	K8012
	K8013
	K8014
	K8015
	K8016
	K8017
	K8018
	K8019
	K8024

### Dispenser afbakeningslint Dispenser ruban de balisage



K1201

### GEPERSONALISEERD LINT RUBAN PERSONNALISE

75mmx300m (Rol - Rouleau)



Vanaf 16 rollen met eigen tekst en/of logo. A partir de 16 rouleaux avec votre propre texte et/ou logo.

### Ondergronds waarschuwingslint

40mmx250m-100 Micron

### Rubans d'avertissement sous-terrain

40mmx250m -100 Micron

	K8101
	K8105
	K8102
	K8108

	K8103
	K8106
	K8104
	K8107

<b>Acryl:</b> 70% meer weerbaarheid dan glas UV-stabiel Licht gewicht Schokbestendig	<b>Acrylique:</b> 70 % plus résistant que le verre UV stabil Poids léger A l'épreuve des chocs	<b>Polycarbonaat:</b> Bijna onbreekbaar UV-stabiel Licht gewicht Niet ontvlambaar	<b>Polycarbonate:</b> Presque incassable UV stabil Poids léger Non-inflammable	<b>Inox:</b> Bijna onbreekbaar UV-stabiel Bestand tegen hoge temperaturen Bestand tegen chemische producten	<b>Inox:</b> Presque incassable UV stabil Résistant aux températures élevées Résistant aux produits chimiques
--	--	---	--	---	---



**Binnen- en buitengebruik**  
Bevestiging voor paal diam. 50 - 85mm inbegrepen

**Usage intérieur et extérieur**  
Fixation pour poteau 50 - 85mm diam. incluse

Afmetingen Dimensions	Zichtwijdte Rayon	Acryl Acrylique	Polycarbonaat Polycarbonate
600mm Diam.	9-15m	TMAC60	TMPC60
800mm Diam.	15-22m	TMAC80	TMPC80
600x400mm BxH/LxH	9-15m	TMAC4060	TMPC4060
800x600mm BxH/LxH	15-22m	TMAC6080	TMPC6080
1000x800mm BxH/LxH	22-27m	TMAC8010	TMPC8010
1200x1000mm BxH/LxH	27-32m	TMAC1001	



**Met geïntegreerd verwarmingselement**  
**Buitengebruik**  
Bevestiging voor paal diam. 50 - 85mm inbegrepen

**Avec élément de chauffage intégré**  
**Usage extérieur**  
Fixation pour poteau 50 - 85mm diam. incluse

Afmetingen Dimensions	Zichtwijdte Rayon	Acryl Acrylique	Polycarbonaat Polycarbonate
600x400mm BxH/LxH	9-15m	TMHAC4060	TMHPC4060
800x600mm BxH/LxH	15-22m	TMHAC6080	TMHPC6080
1000x800mm BxH/LxH	22-27m	TMHAC80100	TMHPC80100
1200x1000mm BxH/LxH	27-32m	TMHAC100120	



**Anti-condensatiespiegel met speciale coating**  
**Buitengebruik**  
Bevestiging voor paal diam. 50 - 85mm inbegrepen

**Miroir anti-condensation avec couche spéciale**  
**Usage extérieur**  
Fixation pour poteau 50 - 85mm diam. incluse



Afmetingen Dimensions	Zichtwijdte Rayon	Inox
600mm Diam.	9-15m	TMBINOX60
800mm Diam.	15-22m	TMBINOX80
600x400mm BxH/LxH	9-15m	TMBINOX4060
800x600mm BxH/LxH	15-22m	TMBINOX6080

## Palen & Toebehoren

## Poteaux & Accessoires

### Palen Poteaux

Lengte Longueur	Galva	Galva
	Diam. 51mm	Diam. 76mm
2500mm	K3114	K3214
3000mm	K3115	K3215
3500mm	K3116	K3216
4000mm	K3117	K3217

### Paaldoppen Calottes

Diam. Diam.	
51mm	K3101
76mm	K3201



### Haakse bevestigingsarm met dop Bras en drapeau avec calotte

Lengte Longueur	Diam 76mm
600mm	WH60
400mm	WH76



### Bevestigingsarm vork Bras support fourche

Lengte Longueur	Diam 60mm
960mm	WHX2



### Paalvoeten Pieds d'encrage

Diam. Diam.	Gew. Poids	Beton
51mm	33kg	K3108
76mm	52kg	K3208



Bevestigen op een paal met max ø80mm  
A fixer sur un poteau de max ø80mm

## Industriële spiegels

## Miroirs industriels



Afmetingen Dimensions	Zichtw. Rayon	ACRYL ACRYL.	POLYCARBONAAT POLYCARBONATE
500mm Diam.	5-7m	TMIAAC50	TMIPC50
600mm Diam.	9-15m	TMIAAC60	TMIPC60
800mm Diam.	15-22m	TMIAAC80	TMIPC80
600x400mm BxH/LxH	9-15m	TMIAAC406	TMIPC406
800x600mm BxH/LxH	15-22m	TMIAAC608	TMIPC608

Binnen- en tijdelijk buitengebruik  
Bevestiging voor paal diam. 50 - 85mm inbegrepen

Usage intérieur et extérieur temporaire  
Fixation pour poteau 50 - 85mm diam. incluse

Afmetingen Dimensions	Zichtw. Rayon	ACRYL ACRYL.
500mm Diam.	5-7m	USTMI50
600mm Diam.	9-15m	USTMI60
600x400mm BxH/LxH	5-7m	USTMI406
600x800mm BxH/LxH	9-15m	USTMI608
800x1000mm BxH/LxH	15-22m	USTMI801



Binnen- en buitengebruik  
Bevestiging voor paal diam. 50 - 85mm inbegrepen

Usage intérieur et extérieur  
Fixation pour poteau 50 - 85mm diam. incluse

Afmetingen Dimensions	Zichtw. Rayon	ACRYL ACRYL.
500x300mm BxH/LxH	5-7m	CP3050
600x400mm BxH/LxH	7-12m	CP4060
900x600mm BxH/LxH	12-25m	CP6090

Binnengebruik  
Muurbevestiging inbegrepen

Usage intérieur  
Fixation murale incluse



Inox spiegelplaat resistent tot 350°C  
Miroir inox résistant jusqu'à 350°C

Afmetingen Dimensions	Zichtw. Rayon	INOX INOX
450x600mm BxH/LxH	9-15m	INOXHF4560
600mm diam.	9-15m	INOXHF60

Binnengebruik  
Muurbevestiging inbegrepen

Usage intérieur  
Fixation murale incluse

## Achteruitkijkspiegels

## Rétroviseurs

Afmetingen Dimensions	Zichtw. Rayon	ACRYL ACRYL.
250mm	1-2m	TRANS25*
450mm	1-2m	TRANS45
650mm	9-15m	TRANS60
800mm	15-20m	TRANS80

\*voor plaatsing op vorklift / pour placement sur chariot élévateur



Binnengebruik  
Muurbevestiging inbegrepen

Usage intérieur  
Fixation murale incluse

Afmetingen Dimensions	Zichtw. Rayon	ACRYL ACRYL.
600mm	9-15m	EXPLOR60
800mm	15-20m	EXPLOR80



Binnen- en buitengebruik  
Muurbevestiging inbegrepen

Usage intérieur et extérieur  
Fixation murale incluse

**Bewakingspiegels**

**Miroirs de surveillance**

Afmetingen Dimensions	Zichtw. Rayon	ACRYL ACRYL.
350mm Diam.	1-4m	SM35
500mm Diam.	5-7m	SM50
600mm Diam.	9-15m	SM60
800mm Diam.	15-22m	SM80
600x400mm BxH/LxH	9-15m	SM4060
800x600mm BxH/LxH	15-22m	SM6080



**Binnen- en buitengebruik**  
Telescopische arm 300 - 500mm inbegrepen

**Usage intérieur et extérieur**  
Bras télescopique 300 - 500mm inclus



Afmetingen Dimensions	Zichtw. Rayon	ACRYL ACRYL.
300mm Diam.	1-4m	ECUS30
400mm Diam.	1-5m	ECUS40
500mm Diam.	5-7m	ECUS50
600mm Diam.	9-15m	ECUS60
700mm Diam.	12-17m	ECUS70
800mm Diam.	15-22m	ECUS80

**Binnen- en buitengebruik**  
Telescopische arm 300 - 500mm inbegrepen

**Usage intérieur et extérieur**  
Bras télescopique 300 - 500mm inclus



Afmetingen Dimensions	Zichtw. Rayon	ACRYL ACRYL.
300mm Diam.	1-4m	ECRS30
400mm Diam.	1-5m	ECRS40
500mm Diam.	5-7m	ECRS50
600mm Diam.	9-15m	ECRS60
700mm Diam.	12-17m	ECRS70
800mm Diam.	15-22m	ECRS80
600x400mm BxH/LxH	1-5m	ECRS4060
800x600mm BxH/LxH	9-15m	ECRS6080

**Binnengebruik**  
Telescopische arm 300 - 500mm inbegrepen

**Usage intérieur**  
Bras télescopique 300 - 500mm inclus

Afmetingen Dimensions	Zichtw. Rayon	ACRYL ACRYL.
400x300mm BxH/LxH	1-4m	IPAC3040
1000x300mm BxH/LxH	1-8m	IPAC3010
600x400mm BxH/LxH	1-6m	IPAC4060
1000x500mm BxH/LxH	1-8m	IPAC5010
800x600mm BxH/LxH	1-6m	IPAC6080
1000x750mm BxH/LxH	1-10m	IPAC7510



**Binnengebruik**  
Aluminium frame inbegrepen

**Usage intérieur**  
Cadre en aluminium inclus

**Palen & Toebehoren**

**Poteaux & Accessoires**

**Palen  
Poteaux**

Lengte Longueur	Galva Diam. 51mm	Galva Diam. 76mm	Rood Diam. 51mm
2500mm	K3114	K3214	K3172
3000mm	K3115	K3215	K3173
3500mm	K3116	K3216	K3174
4000mm	K3117	K3217	K3175

**Paaldoppen  
Calottes**

Diam. Diam.	
51mm	K3101
76mm	K3201



**Paalvoeten  
Pieds d'encrage**

Diam. Diam.	Gew. Poids	Beton Beton
51mm	33kg	K3108
76mm	52kg	K3208



**Haakse bevestigingsarm met dop  
Bras en drapeau avec calotte**

Lengte Longueur	Diam 76mm
600mm	WH60
400mm	WH76



**Bevestigingsarm vork  
Bras support fourche**

Lengte Longueur	Diam 60mm
960mm	WHX2



Bevestigen op een paal met max ø80mm  
A fixer sur un poteau de max ø80mm

Afmetingen Dimensions	Zichtw. Rayon	ACRYL ACRYL.
500x300mm BxH/LxH	1m	CM3050
600x400mm BxH/LxH	1m	CM4060
900x600mm BxH/LxH	1m	CM6090



**Binnengebruik**  
Telescopische arm 300 - 500mm inbegrepen

**Usage intérieur**  
Bras télescopique 300 - 500mm inclus

Afmetingen Dimensions	ACRYL ACRYL.	Met LED Avec LED
250mm Diam.	INSP25	INSPL25
350mm Diam.	INSP35	INSPL35
400x200mm BxH/LxH	INSP2040	TNSPL2040



**Binnen- en tijdelijk buitengebruik**  
3-delige telescopische arm 400 - 1100mm inbegrepen

**Usage intérieur et extérieur temporaire**  
Bras télescopique 400 - 1100mm, en 3 pièces, inclus

## Winkelspiegels

## Miroirs de magasin

Afmetingen Dimensions	Zichtw. Rayon	ACRYL ACRYL.	POLYCARBONAAT POLYCARBONATE
600mm	90°	10-15m	BMPC60360
800mm	90°	15-20m	
1000mm	90°	25-30m	
600mm	180°	10-15m	
800mm	180°	15-20m	
1000mm	180°	25-30m	
Ø600mm	360°	16-20m	
Ø800mm	360°	21-30m	
Ø900mm	360°	30-40m	
Ø1000mm	360°	40-50m	
Ø1250mm	360°	50-60m	



**Binnengebruik**  
Voor rechtstreekse plafondbevestiging of met ketting

**Usage intérieur**  
Pour placement plafond direct ou avec chaînes

**Kettingen voor spiegels - 360°**  
**Chaînes pour miroirs - 360°**



Voor formaat spiegels Pour dimension miroirs	Langte ketting Longueur chaîne	
500-1000mm	1000mm	BM100K
1250mm	2500mm	BM125K

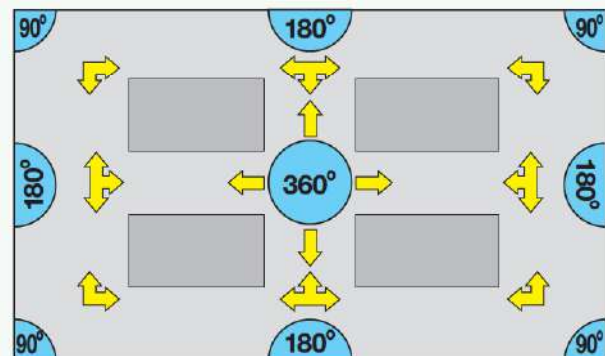

Levenslange PELI-garantie op de behuizing

**YOU BREAK IT, WE REPLACE IT... FOREVER™**

Garantie PELI à vie sur le chassis

- gr** gewicht met batterijen  
poids avec piles
- 00 LUMENS** lichthoeveelheid  
quantite lumineuse
- 000m** straalafstand  
portee faisceau
- batterijen (\*= niet inbegrepen)  
batteries (\* = non-incluses)
- oplaadbare batterij  
batterie rechargeable

- EX** Zone 0: zeker gevaar - danger certain  
Zone 1: mogelijk gevaar - danger possible
- IPX4** waterbestendig  
resiste a l'eau
- IPX7** waterdicht (tot 30min)  
étanche (jusqu'à 30min)
- LED of Xenon  
LED ou Xenon
- kleur**  
couleur

**VB3**

**VB3**

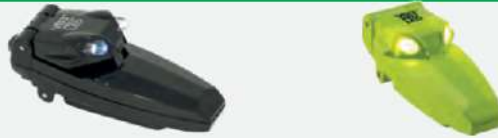

ref.nr. ref.n°	Omschrijving Description	<b>gr</b>	<b>&lt;CM&gt;</b>	<b>00 LUMENS</b>	<b>000m</b>				
2220	Versabrite® 3 Zone 1	30gr	8,9cm	9	12m	2CR2032	LED	Zone 1	
2220	Versabrite® 3 Zone 1	30gr	8,9cm	9	12m	2CR2032	LED	Zone 1	

**L1 LED**

**L1LED**



ref.nr. ref.n°	Omschrijving Description	<b>gr</b>	<b>&lt;CM&gt;</b>	<b>00 LUMENS</b>	<b>000m</b>				
1930	L1	30gr	6,7cm	12	17m	4LR44	LED	-	
1930	L1 Zone 0	30gr	6,7cm	12	17m	4LR44	LED	Zone 0	

**Mitylite**

**Mitylite**



ref.nr. ref.n°	Omschrijving Description	<b>gr</b>	<b>&lt;CM&gt;</b>	<b>00 LUMENS</b>	<b>000m</b>				
1904	Mitylite® Vervanglamp Lampe de rechange						Xenon		
1965	Mitylite® Zone 0	50gr	13,9cm	34	51m	2AAA	LED	Zone 0	

3310

3310



3310PL



3310ELS



3315

ref.nr.  
ref.n°

Omschrijving  
Description



3310

3310PL



180gr

15,6cm

234-28

164m

3AA

LED

-

Photo Lum

3310ELS

3310 Emergency Lighting Station



180gr

15,6cm

234-28

164m

3AA

LED

-

Photo Lum

33150

3315 Zone 0



180gr

15,6cm

138

164m

3AA

LED

Zone 0

■

Stealthlite

Stealthlite



2450



2410LED

ref.nr.  
ref.n°

Omschrijving  
Description



2404  
&  
2404Z1

Stealthlite® Vervanglamp  
Lampe de recharge

Xenon

2410

Stealthlite® LED



210gr

17,8cm

153

161m

4AA

LED

-

■

2410

Stealthlite® Z0



210gr

17,8cm

153

161m

4AA\*

LED

Zone 0

■ ■

2460

Stealthlite® LED



220gr

17,8cm

112

153m

4AANiMH

LED

-

■ ■

2460

Stealthlite® LED Z1



220gr

17,8cm

112

153m

4AANiMH

LED

Zone 1

■

Little Ed

Little Ed

ref.nr. ref.n°	Omschrijving Description									
3610	Little Ed® LED Z0		300gr	19,1cm	153	161m	4AA*	LED	Zone 0	
3660	Little Ed® LED Z1		300gr	19,1cm	112	153m	4AANiMH	LED	Zone 1	

Sabrelite

Sabrelite

ref.nr. ref.n°	Omschrijving Description									
2004 & 2004Z1	Sabrelite® Vervanglamp Lampe de rechange							Xenon		
2010	Sabrelite® LED		380gr	20,6cm	129	144m	3C*	LED	-	
2010	Sabrelite® Z0		380gr	20,6cm	129	144m	3C*	LED	Zone 0	
2003 & 2013(Z0)	Sabrelite® Fotolumkop Tête Photolum									

3715Z0

3715Z0

ref.nr. ref.n°	Omschrijving Description									
3715	3715Z0		410gr	13,6cm	189-90	278m	4AA*	LED	Zone 0	
3713	3715Z0 Fotolumkop Tête Photolum									

9410L

9410L



9410

9419L

9416L

ref.nr.  
ref.n°

Omschrijving  
Description

gr    <img alt="Beam distance icon"/> cm >    <img alt="Lumens icon"/> LUMENS    <img alt="Range icon"/> 000m    <img alt="Battery icon"/>    <img alt="LED icon"/>    <img alt="Ex icon"/> Ex

9410	9410L	1m	1270gr	22,2cm	-	1131	435m	4DNiMH	LED	
9415	9415Z0	1m	1650gr	29,2cm	-	392	392m	4DNiMH	LED	Zone 0
9419L	Oplaadbare batterij Batterie rechargeable									
9416L	Oplaadstation Station de recharge									

Heads Up Lite

Heads Up Lite



2610



2690



2740

ref.nr.  
ref.n°

Omschrijving  
Description

gr    <img alt="Beam distance icon"/> cm >    <img alt="Lumens icon"/> LUMENS    <img alt="Range icon"/> 000m    <img alt="Battery icon"/>    <img alt="LED icon"/>    <img alt="Ex icon"/> Ex

2610	2610Z0		90gr	3,8cm	30-14	28m	3xAAA	LED	Zone 0	
2690	2690Z0	1m	120gr	7,1cm	74	92m	3xAAA	LED	Zone 0	
2740	2740		90gr	5,7cm	35-13	32m	3xAAA	LED	-	



2745



2755



2760



2765

2745	2745Z0	1m	90gr	5,7cm	33-17	35m	3AAA	LED	Zone 0	
2755	2755Z0	1m	100gr	5,7cm	72-34	57m	3xAAA	LED	Zone 0	
2760	2760	1m	100gr	5,7cm	133-90	117m	3xAAA	LED	-	
2765Z0	2765Z0	1m	96gr	5,7cm	141-68	78m	3xAAA	LED	Zone 0	

Tactical light (kunststof)

Tactical light (matière synthétique)



7060



8060



8054

8056

ref.nr.  
ref.n°

Omschrijving  
Description



7060

7060C



290gr

22,0cm

164-36

243m

1x3,7mAh



LED

-



8054

8050 M11  
Vervanglamp  
Lampe de rechange

8060

8060 AC220



660gr

32,2cm

180-19

277m

4CNiMH



LED

-



8056

12V Sigarettenplug  
12V fiche cigarettes



1910



1920



2350



2360

1910

1910B



40gr

9,6cm

72-14

64m

1AAA

LED

-



1920

1920B



60gr

14,0cm

120-12

87m

2AAA

LED

-



2350

2350B



100gr

10,7cm

100-10

141m

1AA

LED

-



2360

2360B



150gr

15,7cm

250-24

151m

2AA

LED

-



2365



7000

2365

2365C



260gr

55,7cm

65

81m

2AA\*

LED

-



7000

7000



160gr

13,5cm

602-64

233m

2CR123

LED

-



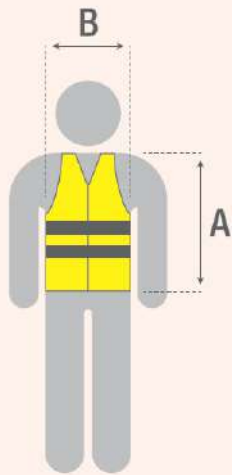

**Fluo geel**  
100% mesh polyester  
Velcro sluiting

**Fluo jaune**  
100% mesh polyester  
Fermeture  
Bande agrippante



	CE EN471-Volwassenen CE EN471-Adultes	Met tekst Avec texte		CE EN1150-Kinderen CE EN1150-Enfants	0-6 jr. 0-6 ans	6-12 jr. 6-12 ans
Medium	A = 650mm B = 600mm	F404 F404.MT	Medium	A = 510mm B = 450mm	F401	
Large	A = 650mm B = 650mm	F405 F405.MT	Large	A = 550mm B = 530mm		F402
XLarge	A = 650mm B = 700mm	F406 F406.MT				

Tekst : 1 lijn - Full colour - 1 zijde  
Texte : 1 ligne - Full colour - 1 côté

## Armbanden

## Brassards



Polyester / Katoen  
Belgische driekleur  
500x90mm  
Velcro sluiting

Polyester / Coton  
Tricolore belge  
500x90mm  
Fermeture  
Bande agrippante



Polyester / Katoen  
Oranje  
430x100mm  
Velcro sluiting

Polyester / Coton  
Orange  
430x100mm  
Fermeture  
Bande agrippante



Set van 2 stuks  
3M reflecterend  
Fluo geel  
370x25mm CE EN13356  
Velcro sluiting

Set de 2 pièces  
3M réfléchissant  
Fluo jaune  
370x25mm CE EN13356  
Fermeture  
Bande agrippante

Zonder tekst Sans texte	Tekst naar keuze Texte à choix	Met/Avec SEINGEVER	Zonder tekst Sans texte	Tekst naar keuze Texte à choix	Zonder tekst Sans texte
F201	F201.MT	F201A	F202	F202.MT	F205

## Seingeverbord

## Panneau signaleur



2251.00



2251.MT

Aluminium seingeverbord C3  
folie reflecterend klasse 1 recto-verso  
Ø220 mm

Panneau signaleur C3 aluminium  
film réfléchissant classe 1 recto-verso  
Ø220 mm

Tekst naar keuze - R/V - Max. 2 lijnen  
Texte à choix - R/V - Max. 2 lignes



2252.01

Kunststof seingeverbord C3  
Reflecterende folie klasse 1  
Ø150 mm, totale lengte 440 mm

Panneau signaleur C3 en plastique  
film réfléchissant classe 1  
Ø150 mm, longueur totale 440 mm



2253.00

Kunststof seingeverbord inwendig  
verlicht - 10 LED's - 3C-batterijen (excl.)  
Ø 220 mm

Panneau signaleur en plastique avec  
illumination - 10 LED's - 3C-piles (excl.)  
Ø 220 mm

## Lamp met signalisatiekegel

## Lampe à cône signalisation



Lamp/Lampe	2010-014-245E
Zone 0	2010-060-241E
Kegel/Cône	8050-980-150E

## Victor veilig

## Victor veilig

Verkeersmaatje victor veilig, hoogte 813 mm, fluorescerend groen met tekst 'slow' en waarschuwingsvlag  
Brede voet opvulbaar met water of zand voor extra stabiliteit

Bonhomme victor veilig, hauteur 813 mm, vert fluorescent avec texte 'slow' et drapeau d'avertissement  
Pied large remplissable avec de l'eau ou du sable pour une stabilité supplémentaire



4050.00

## Snaplight

## Snaplight

	Green	Red	Yellow	Orange	Blue	White
5min.Hl.						9822.09
30min.		9822.07	9822.08			
8u/h.					9822.05	9822.06
12u/h.	9822.01	9822.02	9822.03	9822.04		



## Arm badgehouder

## Porteur de badge bras

	Reflecterend Réfléchissant	147x142mm
Fluo	✓	F210.01
Fluo	✓	F210.02
Fluo	✓	F210.03
		F210.04
Zilver / Argent	✓	F210.05



Voor insert 64x109mm  
Pour insert 64x109mm

**Etiketten op bestelling**  
**\*\* Aanduiding van de subklasse**  
**\* Letter van de samenladingsgroep**

**Etiquettes sur demande**  
**\*\* Indication de la division**  
**\* Indication du groupe de compatibilité**



ADR/RID/IMDG/IATA



Ontploffbare stoffen & voorwerpen-subkl.1.4  
 Matières & objets explosives-sous-cl.1.4

ADR/RID/IMDG/IATA



2.1 Brandbare gassen  
 2.1 Gaz inflammables

ADR/RID/IMDG/IATA



2.1 Brandbare gassen  
 2.1 Gaz inflammables

IMDG/IATA



	VIN.	VIN.	PP	VIN.	PP	VIN.
100x100	2630.114S	2630.A9		2630.A8		1231.30
250x250	2634.1HS	2634.A9		2634.A8		2634.30
300x300	2631.1HS	2631.A9	2621.A9	2631.A8	2621.A8	1233.30

ADR/RID/IMDG/IATA



2.2 Niet-brandbare  
 en Niet-giftige gassen  
 2.2 Gaz non-inflammables  
 et Non-toxiques

ADR/RID/IMDG/IATA



2.2 Niet-brandbare  
 en Niet-giftige gassen  
 2.2 Gaz non-inflammables  
 et Non-toxiques

IMDG/IATA



ADR/RID/IMDG/IATA



2.3 Giftige gassen  
 2.3 Gaz toxiques

IMDG/IATA



ADR/RID/IMDG/IATA



3 Brandbare vloeistoffen  
 3 Liquides inflammables

	VIN.	PP	VIN.	PP	VIN.	VIN.	PP	VIN.	PP
100x100	2630.15		2630.14		1231.09	2630.A7		1231.1A	2630.2E
250x250	2634.15		2634.14		2634.09	2634.A7		2634.1A	2634.2E
300x300	2631.15	2621.15	2631.14	2621.14	1233.09	2631.A7	2621.A7	1233.1A	2631.2E 2621.2E

ADR/RID/IMDG/IATA



3 Brandbare vloeistoffen  
 3 Liquides inflammables

IMDG/IATA



ADR/RID/IMDG/IATA



4.1 Brandbare vaste stoffen,  
 zelfontledende stoffen en  
 gedesebiliseerde ontplofbare stoffen.  
 4.1 Matières solides inflammables.

IMDG/IATA



ADR/RID/IMDG/IATA



4.2 Voor zelfontbranding vatbare stoffen  
 4.2 Matières auto-inflammables

IMDG/IATA



	VIN.	PP	VIN.	PP	VIN.	VIN.	PP	VIN.
100x100	2630.2G		1231.1B		2630.1C	1231.32		2630.2H 1231.B0
250x250	2634.2G		2634.1B		2634.1C	2634.32		2634.2H 2634.B0
300x300	2631.2G	2621.2G	1233.1B		2631.1C 2621.1C	1233.32	2631.2H 2621.2H	1233.B0

ADR/RID/IMDG/IATA



4.3 Stoffen die in contact met water  
 brandbare gassen ontwikkelen.  
 4.3 Matières qui développent des gaz  
 inflammables au contact de l'eau.

ADR/RID/IMDG/IATA



4.3 Stoffen die in contact met water  
 brandbare gassen ontwikkelen.  
 4.3 Matières qui développent des gaz  
 inflammables au contact de l'eau.

IMDG/IATA



ADR/RID/IMDG/IATA



5.1 Oxiderende stoffen  
 5.1 Matières comburantes

IMDG/IATA



ADR/RID/IMDG/IATA



5.2 Organische peroxides  
 5.2 Peroxydes organiques

	VIN.	PP	VIN.	PP	VIN.	VIN.	PP	VIN.	PP
100x100	2630.2K		2630.2J		1231.B1	2630.3A		1231.1D	2630.C1
250x250	2634.2K		2634.2J		2634.B1	2634.3A		2634.1D	2634.C1
300x300	2631.2K	2621.2K	2631.2J	2621.2J	1233.B1	2631.3A	2621.3A	1233.1D	2631.C1 2621.C1

ADR/RID/IMDG/IATA



5.2 Organische peroxides  
 5.2 Peroxydes organiques

IMDG/IATA



ADR/RID/IMDG/IATA



6.1 Giftige stoffen  
 6.1 Matières toxiques

IMDG/IATA



ADR/RID/IMDG/IATA



6.2 Infectieuz (besmettelijke) stoffen  
 6.2 Matières infectieuses

IMDG/IATA



	VIN.	PP	VIN.	PP	VIN.	VIN.	PP	VIN.
100x100	2630.3C		1231.17		2630.4B	1231.1F		2630.6A 1231.28
250x250	2634.3C		2634.17		2634.4B	2634.1F		2634.6A 2634.28
300x300	2631.3C	2621.3C	1233.17		2631.4B 2621.4B	1233.1F	2631.6A 2621.6A	1233.28

# TRAFF-O-SIGN

# TRAFF-O-SIGN

TRAFF-O-SIGN

ADR/RID/IMDG/IATA



7A Radioactieve stoffen  
7A Matières radioactives

ADR/RID/IMDG/IATA



7B Radioactieve stoffen  
7B Matières radioactives

ADR/RID/IMDG/IATA



7B Radioactieve stoffen - Frans  
7B Matières radioactives - Français

ADR/RID/IMDG/IATA



7C Radioactieve stoffen  
7C Matières radioactives

ADR/RID/IMDG/IATA



7D Radioactieve stoffen  
7D Matières radioactives

	VIN.	GREENLINE	VIN.	GREENLINE	VIN.	GREENLINE	VIN.	GREENLINE	VIN.	GREENLINE
100x100	2630.7A	26U0.7A	2630.7B	26U0.7B	2630.B6	26U0.B6	2630.7C	26U0.7C	1231.26	26U0.26
250x250	2634.7A		2634.7B		2634.B6		2634.7C		2634.26	
300x300	2631.7A		2631.7B		2631.B6		2631.7C		1233.26	

ADR/RID/IMDG/IATA



7E Splijtstoffen van klasse 7

ADR/RID/IMDG/IATA

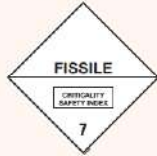

7E Matières fissiles

ADR/RID/IMDG/IATA



8 Bijtende stoffen  
8 Matières corrosives

IMDG/IATA



	VIN.	GREENLINE	VIN.	GREENLINE	VIN.	PP	VIN.
100x100	2630.B7	26U0.B7	2630.B8	26U0.B8	2630.5A		1231.23
250x250	2634.B7		2634.B8		2634.5A		2634.23
300x300	2631.B7		2631.B8		2631.5A	2621.5A	1233.23

ADR/RID/IMDG/IATA



9 Diverse gevaarlijke stoffen en voorwerpen  
9 Autres matières et objets dangereux

ADR/RID/IMDG/IATA



ADR/RID/IMDG/IATA



ADR/RID/IATA



ADR/RID/IMDG



	VIN.	PP	VIN.	VIN. 1000x rol/roul	VIN.	PP	VIN.	PP
100x100	1231.24		1231.64	12N1.64	2630.80N			
250x250	2634.24		2634.64		2634.80N			
300x300	1233.24	2621.24	2631.64		2631.80N	2621.80N	2631.35	2621.35

ADR/RID/IMDG/IATA

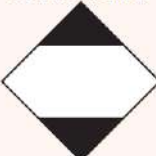

IATA



ADR/RID/IMDG/IATA



ADR/RID/IMDG/IATA



ADR/RID/IMDG/IATA



	VIN.	PP	VIN.	VIN.	PP	VIN.	PP	VIN.	PP
50x50	263C.95		123C.3H						
100x100	2630.95	2620.95	1231.3H	2630.0A		2630.0B		2630.0C	
250x250	2634.95	2624.95	2634.3H	2634.0A		2634.0B		2634.0C	
300x300	2631.95	2621.95	1233.3H	2631.0A	2621.0A	2631.0B	2621.0B	2631.0C	2621.0C

TRAFF-O-SIGN

# TRAFF-O-SIGN

# TRAFF-O-SIGN



VIN.							
100x100	1231.50	1231.51	1231.52	1231.53	1231.54	1231.55	1231.56
250x250	2634.50	2634.51	2634.52	2634.53	2634.54	2634.55	2634.56
300x300	2631.50	2631.51	2631.52	2631.53	2631.54	2631.55	2631.56



VIN.							
100x100	1231.58	1231.59	1231.60	1231.61	1231.57	1231.63	1231.34
250x250	2634.58	2634.59	2634.60	2634.61	2634.57	2634.63	2634.34
300x300	2631.58	2631.59	2631.60	2631.61	2631.57	2631.63	1233.34



Etiketten met code beschikbaar, te vermelden bij bestelling. Bekijk ons aanvullend gamma verpakkingsetiketten op p.311 en 312

Etiquettes disponibles avec code, à mentionner lors de votre commande. Voir notre gammes des etiquettes d'emballage sur p.311 et 312

## Zelfklevers op rol

## Autocollants sur rouleau

Vinyl - Glanzend - Permanente lijm - Per rol van 1000 st.

Vinyle - Brillant - Colle permanente - Par rouleau de 1000 pièces



100x100	12N1.A7	12N1.14	12N1.15	12N1.A8	12N1.A9	12N1.2G	12N1.2E	12N1.1C	12N1.2H
---------	---------	---------	---------	---------	---------	---------	---------	---------	---------



100x100	12N1.2J	12N1.2K	12N1.3A	12N1.3C	12N1.4B	12N1.6A	12N1.7A	12N1.7B	12N1.B6
---------	---------	---------	---------	---------	---------	---------	---------	---------	---------



100x100	12N1.7C	12N1.26	12N1.B7	12N1.B8	12N1.5A	12N1.24	12N1.95	12N1.80N
---------	---------	---------	---------	---------	---------	---------	---------	----------

## Transportlabel op drager

## Etiquette transport sur support

Bord voor ADR symbolen gevaarlijke stoffen, klapbaar

Panneau pour symboles ADR matières dangereuses, pliable

Alu plaat met gekleefd symbool naar keuze  
Plaque alu avec symbole à choix collé

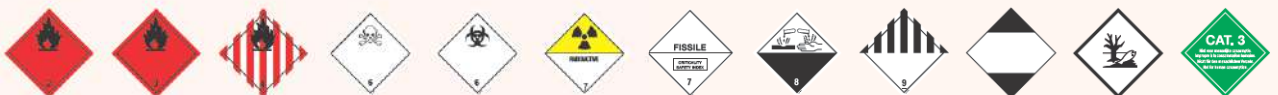

300x300	2609.A8	2609.2G	2609.1C	2609.4B	2609.6A	2609.26	2609.B8	2609.5A	2609.24	2609.95	2609.80N	2609.0C
---------	---------	---------	---------	---------	---------	---------	---------	---------	---------	---------	----------	---------

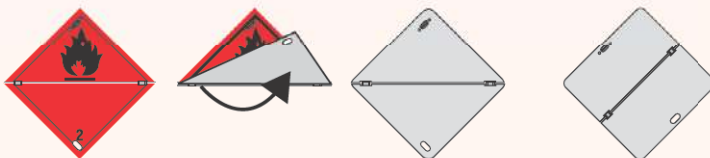

Voorbeeld  
Exemple

Blanco  
ALU 1mm  
300x300 2600.00

Blanco  
ALU 1mm  
300x300 2715.00



**Materiaal :**

- Frame: 2mm geanodiseerd aluminium
- Drager: 1mm geanodiseerd aluminium
- Beugels: 3x rvs
- Sterke veerklemmen: 4x rvs

**Gewicht :** 1,3 kg

**Bevestiging :** 4 verzonken gaten op basisframe

**Matériel :**

- Frame: aluminium anodisé 2mm
- Base: aluminium anodisé 1mm
- Brides: 3x inox
- Pince à ressort fort: 4x inox

**Poids :** 1,3kg

**Fixation :** 4 trous creux dans frame

**Multi gevaarsetikettensysteem met 8 symbolen**  
**Système étiquettes de danger Multi avec 8 symboles**



250x250mm	
8 standaard symbolen / symboles fixe	2618.N1
8 symbolen naar keuze / symboles à choix	2618.MT

*Vergeet niet om het gewenste symbool op te geven!*  
*N'oubliez pas d'indiquer le symbole choisi!*

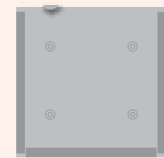
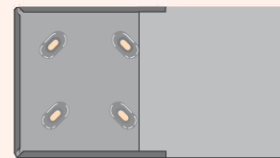
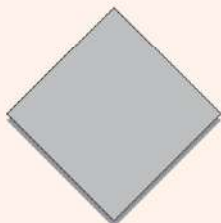

**Blanco plaat voor ADR symbolen gevaarlijke stoffen**  
**Panneau vierge pour symboles ADR matières dangereuses**

**Plaat met ADR symbool gevaarlijke stof**  
**Panneau avec symbole ADR matières dangereuses**

**Plaathouders voor ADR symbolen gevaarlijke stoffen**  
**Supports pour symboles ADR matières dangereuses**

	250x250mm	300x300mm
Alu 1,5mm	2671.00	2619.00
Inox 0,8mm	2672.00	2649.00
Magn. 1,5mm	2675.00	2664.00
PP 1,5mm	2674.00	2665.00

	250x250mm	300x300mm
Alu 1,5mm	2671.MT	2619.MT
Inox 0,8mm	2672.MT	2649.MT
Magn. 1,5mm	2675.MT	2664.MT
PP 1,5mm	2674.MT	2665.MT

	250x250mm	300x300mm
Inox 0,8mm links of rechts / gauche ou droite	2670.00	2644.00
Inox 0,8mm links of rechts / gauche ou droite + 1 clip		264C.00

## ADR Borden zonder code

## Panneaux ADR sans code

	400x300 mm	
	Zonder balk Sans bande	Met balk Avec bande
Vinyl Retrorefl. / Vinyle Rétrorefl.	2607.00	2606.00
Vinyl Nt. retrorefl. / Vinyle Non-rétrorefl.	2601.00	2602.00
PP 1,5mm Retrorefl. / PP 1,5mm Rétrorefl.	2603.00	260D.00
Alu 1mm Retrorefl. / Alu. 1mm Rétrorefl.	2611.00	260E.00
Inox 0,8mm Retrorefl. / Inox 0,8mm Rétrorefl.	260C.00	260G.00
Galvan staal 1mm Retrorefl. / Acier Galvan 1mm Rétrorefl.	260B.00	260F.00
Magn. 1,5mm Retrorefl. / Magn. 1,5mm Rétrorefl.	2604.00	2604.01



ADR bord  
Panneau ADR

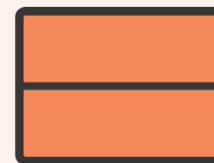

ADR bord met balk  
Panneau ADR avec bande

## Cijfers en letters voor ADR bord

## Chiffres et lettres pour panneau ADR

Vinyl zelfklevend

Vinyle autocollant

	80x115 mm			90x120 mm		
	Transparant Transparent	Oranje retrorefl. Orange rétrorefl.	Oranje nt.-retrorefl. Orange non-rétrorefl.	Transparant Transparent	Oranje retrorefl. Orange rétrorefl.	Oranje nt.-retrorefl. Orange non-rétrorefl.
0	2302.00	2635.00	2303.00	2306.00	2637.00	2307.00
1	2302.01	2635.01	2303.01	2306.01	2637.01	2307.01
2	2302.02	2635.02	2303.02	2306.02	2637.02	2307.02
3	2302.03	2635.03	2303.03	2306.03	2637.03	2307.03
4	2302.04	2635.04	2303.04	2306.04	2637.04	2307.04
5	2302.05	2635.05	2303.05	2306.05	2637.05	2307.05
6	2302.06	2635.06	2303.06	2306.06	2637.06	2307.06
7	2302.07	2635.07	2303.07	2306.07	2637.07	2307.07
8	2302.08	2635.08	2303.08	2306.08	2637.08	2307.08
9	2302.09	2635.09	2303.09	2306.09	2637.09	2307.09
A	2302.A	2635.A	2303.A	2306.A	2637.A	2307.A
B	2302.B	2635.B	2303.B	2306.B	2637.B	2307.B
C	2302.C	2635.C	2303.C	2306.C	2637.C	2307.C
D	2302.D	2635.D	2303.D	2306.D	2637.D	2307.D
E	2302.E	2635.E	2303.E	2306.E	2637.E	2307.E
F	2302.F	2635.F	2303.F	2306.F	2637.F	2307.F



Etc.

## ADR Borden zonder code

## Panneaux ADR sans code

Blanco bord - horizontaal klapbaar - Retroreflecterend  
Panneau vierge - pliable horizontal - Rétro réfléchissant

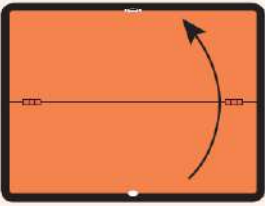

Met tourniquet voor vergrendeling  
Avec tourniquet pour fermeture

Alu 1mm Alu 1mm	Gegalvaniseerd staal 1mm Acier galvanisé 1mm	Inox 0,8mm Inox 0,8mm	Alu 1mm Alu 1mm	Gegalvaniseerd staal 1mm Acier galvanisé 1mm	Inox 0,8mm Inox 0,8mm
400x300	2609.0H	2629.0H	2609.0V	2629.0V	2639.0V

Blanco bord - verticaal klapbaar - Retroreflecterend  
Panneau vierge - pliable vertical - Rétro réfléchissant

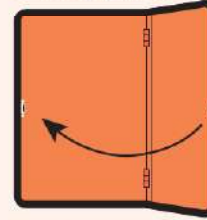

Met tourniquet voor vergrendeling  
Avec tourniquet pour fermeture

Blanco bord - verticaal klapbaar met beugel - Retroreflecterend  
Panneau vierge - pliable vertical avec support - Rétro réfléchissant

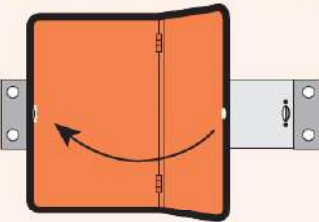

Met tourniquet voor vergrendeling  
Avec tourniquet pour fermeture

Alu 1mm Alu 1mm	Gegalvaniseerd staal 1mm Acier galvanisé 1mm	Inox 0,8mm Inox 0,8mm	Gegalvaniseerd staal 1mm Acier galvanisé 1mm
400x300	2608.00	2628.00	2641.00

Bord dubbel gebruik (2 in 1) - Retroreflecterend  
Panneau à double emploi (2 en 1) - Rétro réfléchissant

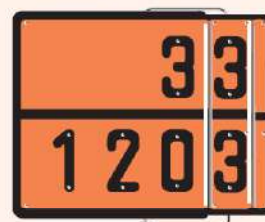

Code 30/1202 + 33/1203



## ADR Plaathouders

## Supports panneaux ADR

Plaathouder  
Support panneau



+ 2 schuifclips  
+ 2 clips glissants

Inox	Inox	Inox
400x300	264B.00	264F.00

Houder voor verwisselbare cijfers  
Support pour chiffres interchangeables

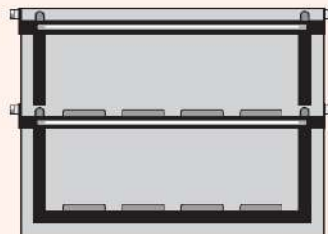

met veer en vaste achterplaat  
avec ressort et plaque arrière fixe

Houder voor verwisselbare cijfers  
Support pour chiffres interchangeables



met 4 gaten  
avec 4 trous

Houder voor verwisselbare cijfers  
Support pour chiffres interchangeables

Voorkant  
Face avant



Inox met 2 beugels / Inox avec 2 brides

400x300	264G.00
---------	---------

Achterkant - met 2 beugels  
Face arrière - avec 2 brides





voorbeeld: 2655.01

400x300mm

- 260N** ... Vinyl - niet retroreflecterend  
Vinyle - non-rétro réfléchissant
- 2605** ... Vinyl - retroreflecterend  
Vinyle - rétro réfléchissant
- 2655** ... Gegalvaniseerd staal  
Acier galvanisé



20/1046	133	268/1005	130	30/3272	86	33/2412	206	50/2428	27	80/1726	85	80/3266	50
20/3159	184	29/2590	44	30/3295	28	33/3065	103	50/3375	210	80/1760	87	80/3267	81
20/3163	191	3/1220	209	33/1088	23	33/3292	145	50/3378	172	80/1779	10	80/3320	205
21/1972	212	30/1120	189	33/1090	60	33/3295	125	539/3109	80	80/1789	17	80/3412	19
22/1046	214	30/1123	199	33/1129	139	336/1093	65	559/2015	22	80/1791	41	80/3735	99
22/1073	176	30/1148	90	33/1139	51	336/1184	93	58/2014	21	80/1805	49	83/1715	59
22/1951	95	30/1171	198	33/1169	98	336/1230	168	60/1260	196	80/1814	111	83/1779	43
22/1963	137	30/1202	01	33/1170	140	336/1992	144	60/1547	75	80/1819	185	83/2051	187
22/1977	113	30/1212	194	33/1173	116	336/2381	148	60/1557	135	80/1823	20	83/2734	188
22/2187	35	30/1223	02	33/1193	52	336/3079	61	60/1593	106	80/1824	13	83/2789	89
22/2201	177	30/1263	170	33/1197	97	338/1160	178	60/1671	158	80/1830	14	83/2920	175
223/1046	211	30/1268	42	33/1202	73	338/1221	83	60/1708	138	80/1908	11	83/3463	76
223/1972	142	30/1274	201	33/1203	03	338/1235	181	60/2078	124	80/1971	109	839/2218	63
225/1073	96	30/1300	105	33/1208	127	339/1218	68	60/2291	53	80/2031	46	85/2031	179
225/2201	91	30/1301	195	33/1213	69	339/1247	118	60/2312	154	80/2209	164	86/2922	84
23/1001	107	30/1307	160	33/1219	197	339/1301	72	60/2588	190	80/2280	71	86/2923	159
23/1012	122	30/1863	26	33/1220	192	339/1917	67	60/2811	36	80/2491	193	885/2031	165
23/1032	94	30/1915	149	33/1245	200	339/1919	117	60/3243	129	80/2582	40	89/2531	126
23/1049	134	30/1933	33	33/1260	123	36/3079	216	60/3281	112	80/2586	157	9/3257	30
23/1055	79	30/1987	150	33/1263	74	382/3129	143	60/3288	136	80/2672	47	90/2315	167
23/1061	101	30/1993	92	33/1268	120	39/2055	78	60/2814	182	80/2693	48	90/2586	171
23/1063	131	30/1999	31	33/1276	204	39/2227	141	66/2078	39	80/2735	77	90/2590	163
23/1083	100	30/2048	128	33/1280	82	39/2348	70	663/1051	207	80/2790	15	90/3077	07
23/1965	04	30/2055	57	33/1294	62	40/1325	115	663/1182	215	80/2794	37	90/3082	32
23/1969	64	30/2265	66	33/1866	119	40/1362	09	663/3079	146	80/2796	12	90/3432	166
23/1971	183	30/2850	208	33/1933	102	40/3175	06	68/3455	203	80/2923	155	90/3509	162
239/1010	147	30/3062	104	33/1987	202	40/3190	161	70/2915	25	80/3066	121	99/3257	05
239/1086	156	30/3065	213	33/1993	34	43/4920	174	70/2916	169	80/3244	08	99/3258	38
263/1016	186	30/3082	132	33/2056	152	462/1408	55	70/3321	24	80/3262	110	X80/1818	173
263/1040	151	30/3092	29	33/2370	58	50/1942	45	78/2978	153	80/3264	16		
265/1017	180	30/3256	18	33/2381	108	50/2067	54	80/1179	88	80/3265	114		

Met nummer naar keuze - Vinyl niet retroreflecterend  
Avec numéro au choix - Vinyle non-rétro réfléchissant

Code	Code	Code	Code
300x120mm	30 230130	1139 23011139	1778 23011778
	33 230133	1197 23011197	1814 23011814
	78 230178	1202 23011202	1823 23011823
	80 230180	1203 23011203	1824 23011824
	90 230190	1219 23011219	1830 23011830
	0432 23010432	1263 23011263	1956 23011956
	0503 23010503	1268 23011268	1965 23011965
	1001 23011001	1300 23011300	1987 23011987
	1005 23011005	1408 23011408	1993 23011993
	1006 23011006	1486 23011486	2051 23012051
	1046 23011046	1726 23011726	2071 23012071
	1070 23011070	1760 23011760	2693 23012693
	1072 23011072	1773 23011773	2735 23012735

Code	Code	Code
100x100mm	3495 12313495	2811 12312811
	34 123134	1805 12311805
	64 123164	1993 12311993
	53 123153	1300 12311300
	60 123160	3373 12313373
	3082 12313082	1197 12311197
	1202 12311202	1719 12311719
		63 123163
		2794 12312794
		2814 12312814
		2900 12312900
		3245 12313245
		3481 12313481
		XXXX 1231XXXX



## ADR-cijfers

## Chiffres ADR

Cijfers voor Kemler en UN borden

Doorgeperste cijfers in inox 0,5mm - Reflecterend - 93,5x135mm



Met boring

Avec perforation

Cijfersets in INOX met opbergzakje in canvas

Sets de chiffres en INOX rangé dans un sac en canvas

27 stuks / pièces		37 stuks / pièces	
4x	6	8x	spatie/espace
3x	1, 2, 3, 8	4x	6
2x	0, 4, 5, 7, spatie/espace	3x	0, 1, 2, 3, 4, 5, 7, 8
1x	X	1x	X
2653.00		2654.00	



Zakje (niet gevuld)  
Sac (non rempli)

2648.00

Chiffres pour panneaux Kemler et UN

Chiffres en relief en inox 0,5mm - Rétro réfléchissant - 93,5x135mm



Cijfers in INOX - 93,5x135mm met perforatie  
Chiffres en INOX - 93,5x135mm avec perforation

Per stuk / Par pièce	
0	2645.00
1	2645.01
2	2645.02
3	2645.03
4	2645.04
5	2645.05
6	2645.06
7	2645.07
8	2645.08
9	2645.09
X	2645.0X
spatie / espace	2646.00

## Toebehoren ADR borden

## Accessoires panneaux ADR

Afdekhoes voor platen 400x300mm

Housse de protection pour panneaux 400x300mm



Donkerbruine canvasstof  
Tissu brun foncé en canvas

400x300mm 2003.00



Vuurvaste afdekhoes voor verwisselbaar ADR bord, met velcrosluiting  
Couverture ininflammable pour panneau ADR interchangeable, avec fermeture auto-agrippante

2004.00



Vuurvaste afdekhoes voor ADR-bord, met velcrosluiting  
Couverture ininflammable pour panneau ADR, avec fermeture auto-agrippante

2005.00



Inox draaisluiting voor klapbaar ADR bord  
Tourniquet en acier inoxydable pour panneau ADR pliable

2013.00



Beugel voor vlakke borden Innox 0,8mm  
Bride pour panneaux plats Innox 0,8mm

2011.00



Clip voor plaathouders  
Clip pour supports panneaux

264E.00

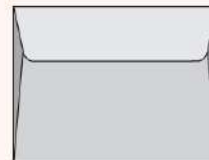

Documenthouder met velcrosluiting  
Support documents à fermeture velcro

264M.00



L: 360mm diam Ø: 70mm

Kunststof koker voor ADR Safety plan  
Manchon en plastique pour le plan de sécurité ADR

JD0C

## ADR borden zonder code

## Panneaux ADR sans code

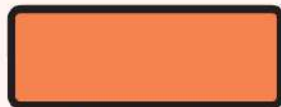

Niet retro reflecterend  
Non-rétro réfléchissant



Niet retro reflecterend  
Non-rétro réfléchissant

Verticaal scharnierend  
À articulation verticale  
Met tourniquet voor vergrendeling  
Avec tourniquet pour fermeture

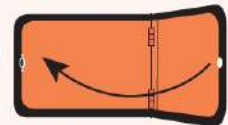

Retro reflecterend  
Rétro réfléchissant

Niet retro reflecterend Non-rétro réfléchissant			Niet retro reflecterend Non-rétro réfléchissant		Retro reflecterend Rétro réfléchissant			
Alu 1mm	Alu 2mm	Inox 0,8mm	Magn. 1,5mm	Vin.	Alu 1mm	Alu 2mm	Inox 0,8mm	
300x120mm	2311.00	2313.00	2312.00	2304.01	2301.01	2309.0V	2329.0V	2319.0V

## TRAFF-O-SIGN

## TRAFF-O-SIGN

## Plaathouders ADR borden

## Supports panneaux ADR



te combineren met houder 264B.00  
à combiner avec support 264B.00



Schuifpaneel voor borden 300x120mm - Set van 2 stuks  
Support glissière pour panneaux 300x120mm - Set de 2 pièces

Inox 0,8mm	
375x135mm	2643.00

Plaathouder + 1 schuifclip  
Support panneau + 1 clip glissant

Inox 0,8mm	
300x120mm	264N.00

## Diverse transport

## Transport divers

A-bord voor afvaltransport  
Retroreflecterend wit

Panneau A pour transport de déchets  
Rétro réfléchissant blanc

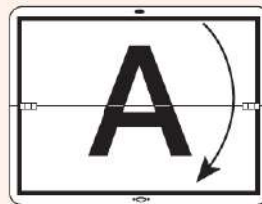

Horizontaal scharnierend  
À articulation horizontale

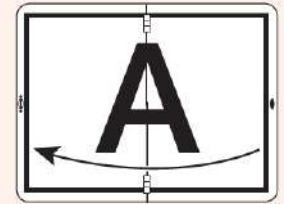

Verticaal scharnierend  
À articulation verticale

	Vin.	Alu 1mm	Alu 2mm	Alu 1mm	Alu 2mm	Alu 1mm	Alu 2mm
400x300mm	2613.01	2611.01	261A.01	2609.02	26A9.02	2609.03	26A9.03

TIR bord

Panneau TIR



Horizontaal scharnierend  
À articulation horizontale



Verticaal scharnierend  
À articulation verticale



Verticaal scharnierend op beugel  
À articulation verticale sur support

	PP 1,5mm	Alu 1mm	Alu 1mm	Alu 1mm	Alu 1mm
400x250mm	2721.00	2711.00	2712.00	2712.01	2708.00



Schoolbusbord - Retroreflecterend - Klasse I  
Panneau bus scolaire - Rétroréfléchissant - Classe I

Industriebord - Retroreflecterend - Klasse I  
Panneau pour l'industrie - Rétroréfléchissant - Classe I

	PP 1,5mm		VIN.		Alu 1mm		Magn. 1,5mm		Alu 1mm - Verticaal scharnierend Alu 1mm - À articulation verticale		Alu 1mm - Horizontaal scharnierend Alu 1mm - À articulation horizontale		PP 1,5mm		VIN.		Alu 1mm		Alu 1mm - Verticaal scharnierend Alu 1mm - À articulation verticale	
250x250mm	2722.01	2732.01	2713.01	2703.01		2715.01			2715.01H			2722.02	2732.02	2713.02		2719.02				
400x400mm	2724.01	2734.01	2714.01	2704.01		2716.01			2716.01H			2724.02	2734.02	2714.02		271A.02				



	VIN.	Magn. 0,85mm	VIN.	Magn. 0,85mm
170x250mm	273B.01	270B.01	273B.02	270B.02

### Maximum snelheidsbord



	5 km	10 km	20 km	25 km	30 km	40 km	60 km	70 km	75 km	80 km	90 km	100 km	
ALU 1mm	2211.00	2211.05	2211.10	2211.20	2211.25	2211.30	2211.40	2211.60	2211.70	2211.75	2211.80	2211.90	2211.11
PP 1,5mm	2221.00	2221.05	2221.10	2221.20	2221.25	2221.30	2221.40	2221.60	2221.70	2221.75	2221.80	2221.90	2221.11
VIN.	2231.00	2231.05	2231.10	2231.20	2231.25	2231.30	2231.40	2231.60	2231.70	2231.75	2231.80	2231.90	2231.11

### Panneau de limitation de vitesse

Snelheidsplaat  
Retroreflecterend - Klasse I -  
Diam 210mm

Panneau vitesse  
Rétroréfléchissant - Classe I -  
Diam 210mm

### Tarra sets Vinyl

### Sets Tare Vinyle

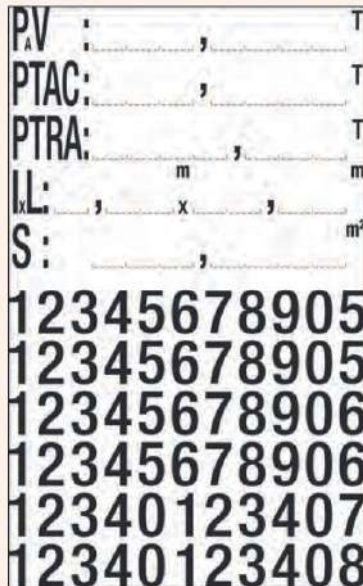

130x100mm 2831SET  
170x130mm 2832SET

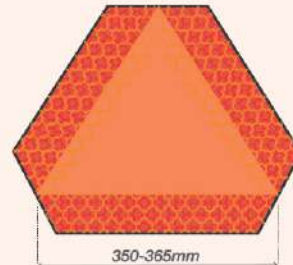

Bord langzaam rijdend verkeer  
Retroreflecterend - Klasse II & Fluo Rood  
Panneau véhicules lents  
Rétroréfléchissant - Classe II & Fluo Rouge

VIN. Alu 1,2mm  
2660.00 2661.00

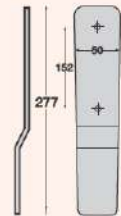

Montagebeugel  
in gegalvaniseerd staal  
Support de montage  
en acier galvanisé

2662.00

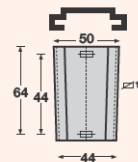

Steun in gegalvaniseerd staal  
Support en acier galvanisé

2663.00



Blijf uit de

VIN.

700x400mm 1736.V0

### LED-werflamp - Fotocel Flikkerend & Statische functie



MAXI 5

2 batterijen nodig  
2 batteries nécessaires



4R256V

### Lampe chantier LED - Photo-cellule Fonction clignotante & Statique

### Voor vrachtwagens vanaf 3500kg - Retroreflecterend - klasse II



T1132

1132x132mm

Alu 1mm Vlak / Plat	2437.00
Alu 1mm Geprofil. / Profilé	2417.00
Zelfklevend / Autocollant	2430.01



Set van 4 stuks: 2x rechts, 2x links / Set de 4 pièces: 2x droite, 2x gauche - T283

283x132mm

Alu 1mm Vlak / Plat	2439.04
Zelfklevend / Autocollant	

### Pour camions à partir de 3500kg - Rétro réfléchissant - Classe II



Vlak / Plat

Geprofileerd / Profilé



Set van 2 stuks: 1x rechts, 1x links / Set de 2 pièces: 1x droite, 1x gauche - T566

566x132mm

Alu 1mm Vlak / Plat	2438.02
Zelfklevend / Autocollant	2435.00

### Voor opleggers vanaf 3500kg - Retroreflecterend - klasse II



R1132

1132x197mm

Alu 1mm Vlak / Plat	2440.01
Alu 1mm Geprofil. / Profilé	
Zelfklevend / Autocollant	2430.00

### Pour remorques à partir de 3500kg - Rétro réfléchissant - Classe II

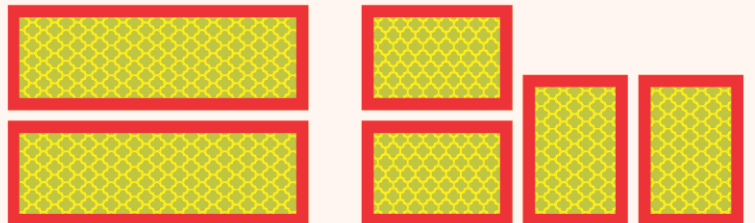

Set van 2 stuks - R566

566x197mm

Alu 1mm Vlak / Plat	2443.02
Alu 1mm Geprofil. / Profilé	2424.00
Zelfklevend / Autocollant	2442.00

Set van 4 stuks - R283

283x197mm

Alu 1mm Vlak / Plat	2444.04
Zelfklevend / Autocollant	

### Laadklepvlagen

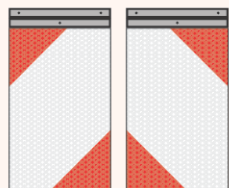

Wit retroreflecterend - Transparent rood  
Rétro réfléchissant blanc - Rouge transparent

250x400mm

2310.00

Set van 2 prismatische rood-wit reflecterende  
waarschuwingsvlagen voor laadplatforms, met  
aluminium houder

Ensemble de 2 drapeaux d'avertissement réfléchissant  
prismatiques rouge-blanc pour les plateformes de  
chargement, avec support en alu

### Drapeau d'avertissement pour hayon élévateur



## Voertuigmarkering

### Contourmarkering conform EC104 norm

#### Voor dekzeilen - Pour baches

ROL	Reflexite VC 104		
	Wit / Blanc	Geel / Jaune	Rood / Rouge
50mmx50m	2030.01	2030.02	2030.03

#### Voor harde ondergrond - Pour surfaces rigides

ROL	Reflexite VC 104		
	Wit / Blanc	Geel / Jaune	Rood / Rouge
50mmx50m	2031.01	2031.02	2031.03

ROL	3M Scotchlite Diamond Grade		
	Wit / Blanc	Geel / Jaune	Rood / Rouge
55mmx50m	2021.01	2021.02	2120.03

## Marquage de véhicule

### Marquage de contour conforme norme EC104

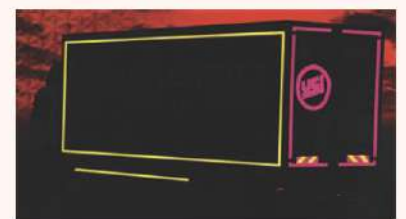

### Gesegmenteerde contourmarkering conform EC104 norm

### Marquage de contour segmenté conforme norme EC104

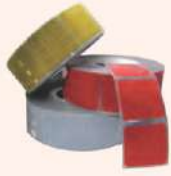

Voorgesneden stickers voor dekzeilen  
Autocollants pré-coupés pour bâches  
Reflexite VC 104

rol / roule 50m	50x50mm
Wit / Blanc	2050.01
Geel / Jaune	2050.02
Rood / Rouge	2050.03



Voorgesneden stickers voor harde ondergrond  
Autocollants pré-coupés pour surfaces rigides  
Reflexite VC 104

rol / roule 10m	160x50mm
Wit / Blanc	2051.01
Geel / Jaune	2051.02
Rood / Rouge	2051.03

### Avery Dennison HVI200- Retroreflecterend

### Avery Dennison HVI200- Rétro réfléchissant

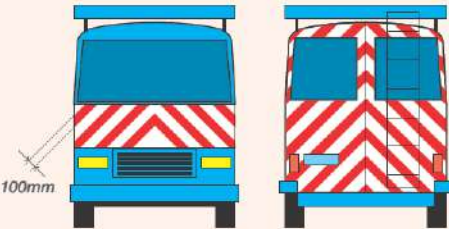

600x1000mm	Rechts / droite	Links / gauche
rood-wit / rouge-blanc	2041.01	2041.02

### Signalisatie containers - Retroreflecterend - klasse II

### Signalisation conteneurs - Rétro réfléchissant - Classe II

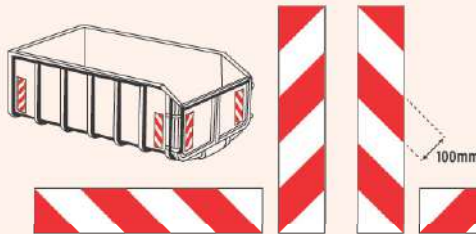

	Set van 8 stuks: 4x rechts, 4x links Set de 8 pièces: 4x droite, 4x gauche	1 stuk verticaal linkslopend 1 pièce direction gauche verticale	1 stuk verticaal rechtslopend 1 pièce direction droite verticale
	705x141mm	705x141mm	705x141mm
Vin.	243A.00	243B.01	243B.02
Alu 1mm	243C.00	243D.01	243D.02
Magn. 0,85mm	243E.00	243F.01	243F.02

### Signalisatie containers

### Signalisation conteneurs



	400mm	700mm
Alu plat KL.I	K4101.D1	K4102.D1
Alu plat KL.III	K4K02.D1	K4K02.D1
Vin. KL.I	K4A01.D1	K4A02.D1
Magn. 0,9mm KL.I	K4M01.D1	
T2000 KL.II	K6A01.D1	K6A02.D1
T2000 KL.III	K6K01.D1	K6K02.D1
SB250 KL.II	K7A01.D1c	K7A02.D1c
SB250 KL.III	K7K01.D1c	K7K02.D1c
SB250 KL.II	K7A01.D1d	K7A02.D1d
SB250 KL.III	K7K01.D1d	K7K02.D1d

	400mm	700mm
Alu plat KL.I	K4201.A31	K4202.A31
Alu plat KL.III	K4L02.A31	K4L02.A31
Vin. KL.I	K4B01.A31	K4B02.A31
T2000 KL.III	K6L01.A31	K6L02.A31
SB250 KL.III	K7L01.A31	K7L02.A31
Magn. 0,9mm KL.I	K4P01.A31	



### Wielkeg

### Cale de roue



Gegalvaniseerd/ Galvanisé



Rubber / Caoutchouc



Geel polypropyleen  
Polypropylène jaune



Geel polypropyleen  
Polypropylène jaune



Geel polypropyleen  
Polypropylène jaune

380x160mm	260x160x190mm	467x198x220 mm	383x193x160 mm	335x122x147 mm
WIELKEG01	WIELKEG02	WIELKEG03	WIELKEG04	WIELKEG05

### Wielkeg - opbergstelsel

### Cale de roue - système de stockage



WIELKEG03A



WIELKEG03B  
WIELKEG04B



WIELKEG03C  
WIELKEG04C



WIELKEG05A

### UITZONDERLIJK VERVOER

	1000x160mm	1250x250mm
Vinyl - Fluo-rood	2530.01	2531.01
Vinyle - Fluo-rouge		
Vinyl - Geel retroreflecterend - KL1	2530.R1	2531.R1
Vinyle - Jaune rétro réfléchissant - CL1		
Alu 1,5mm - Fluo-rood	2510.01	2511.01
Alu 1,5mm - Fluo-rouge		
Alu 1,5mm - Geel retroreflecterend - KL1	2510.R1	2511.R1
Alu 1,5mm - Jaune rétro réfléchissant - CL1		
Zeldoek - Geel retroreflecterend - KL 2	2554.01	2553.01
Bache - Jaune rétro réfléchissant - CL 2		

### SCHWERTRANSPORT

	1000x160mm	1250x250mm
Vinyl - Fluo-rood	2530.06	2531.06
Vinyle - Fluo-rouge		
Vinyl - Geel retroreflecterend - KL1	2530.R6	2531.R6
Vinyle - Jaune rétro réfléchissant - CL1		
Alu 1,5mm - Fluo-rood	2510.06	2511.06
Alu 1,5mm - Fluo-rouge		
Alu 1,5mm - Geel retroreflecterend - KL1	2510.R6	2511.R6
Alu 1,5mm - Jaune rétro réfléchissant - CL1		

### TRANSPORT EXCEPTIONNEL

	1000x160mm	1250x250mm
Vinyl - Fluo-rood	2530.02	2531.02
Vinyle - Fluo-rouge		
Vinyl - Geel retroreflecterend - KL1	2530.R2	2531.R2
Vinyle - Jaune rétro réfléchissant - CL1		
Alu 1,5mm - Fluo-rood	2510.02	2511.02
Alu 1,5mm - Fluo-rouge		
Alu 1,5mm - Geel retroreflecterend - KL1	2510.R2	2511.R2
Alu 1,5mm - Jaune rétro réfléchissant - CL1		
Zeldoek - Geel retroreflecterend - KL 2	2554.R2	2553.R2
Bache - Jaune rétro réfléchissant - CL 2		

### CONVOI EXCEPTIONNEL

	1000x160mm	1250x250mm	1900x250mm
Vinyl - Fluo-rood	2530.0A	2531.0A	
Vinyle - Fluo-rouge			
Vinyl - Geel retroreflecterend - KL1	2530.RA	2531.RA	
Vinyle - Jaune rétro réfléchissant - CL1			
Vinyl - Geel retroreflecterend - KL2			2537.RA
Vinyle - Jaune rétro réfléchissant - CL2			
Alu 1,5mm - Fluo-rood	2510.0A	2511.0A	
Alu 1,5mm - Fluo-rouge			
Alu 1,5mm - Geel retroreflecterend - KL1	2510.RA	2511.RA	
Alu 1,5mm - Jaune rétro réfléchissant - CL1			
Alu 2mm - Geel retroreflecterend - KL2			2517.RA
Alu 2mm - Jaune rétro réfléchissant - CL2			
Zeldoek - Geel retroreflecterend - KL 2	2554.RA	2553.RA	2552.RA
Bache - Jaune rétro réfléchissant - CL 2			

### CONVOI EXCEPTIONNEL

	1250x400mm
Alu 2mm - Geel retroreflecterend - KL2	2518.RA
Alu 2mm - Jaune rétro réfléchissant - CL2	
Zeldoek - Geel retroreflecterend - KL 2	2551.RA
Bache - Jaune rétro réfléchissant - CL 2	



Plaathouder + 1 schuifclip Support panneau + 1 clip glissant		Bevestigingsset voor zeldoeken Set fixations pour baches	
1000x160mm	1250x250mm		
Inox - 0,8mm	264H.00 264J.00		255SET

### TRANSPORT EXCEPTIONNEL UITZONDERLIJK VERVOER

	1000x320mm	1250x500mm
Vinyl - Geel retroreflecterend - KL1	253B.R4	2534.R4
Vinyle - Jaune rétro réfléchissant - CL1		
Alu 1,5mm - Geel retroreflecterend - KL1	251B.R4	2514.R4
Alu 1,5mm - Jaune rétro réfléchissant - CL1		

### UITZONDERLIJK VERVOER SCHWERTRANSPORT

	1000x320mm	1250x500mm
Vinyl - Geel retroreflecterend - KL1	253B.R7	2534.R7
Vinyle - Jaune rétro réfléchissant - CL1		
Alu 1,5mm - Geel retroreflecterend - KL1	251B.R7	2514.R7
Alu 1,5mm - Jaune rétro réfléchissant - CL1		

### TRANSPORT EXCEPTIONNEL SCHWERTRANSPORT

	1000x320mm	1250x500mm
Vinyl - Geel retroreflecterend - KL1	253B.R8	2534.R8
Vinyle - Jaune rétro réfléchissant - CL1		
Alu 1,5mm - Geel retroreflecterend - KL1	251B.R8	2514.R8
Alu 1,5mm - Jaune rétro réfléchissant - CL1		

### TRANSPORT EXCEPTIONNEL UITZONDERLIJK VERVOER SCHWERTRANSPORT

	1000x480mm	1250x750mm
Vinyl - Geel retroreflecterend - KL1	253C.R0	2536.R0
Vinyle - Jaune rétro réfléchissant - CL1		
Alu 1,5mm - Geel retroreflecterend - KL1	251C.R0	2516.R0
Alu 1,5mm - Jaune rétro réfléchissant - CL1		

## OPGEPAST ZWENKT UIT

## OPGEPAST ZWENKT UIT

	Vinyle - Fluo-rood/rouge	Alu 1,5mm - Fluo-rood/rouge	Vinyl - Geel/Jaune Retrorefl. KL I	Alu 1,5mm - Geel/Jaune Retrorefl. KL I
1000x160mm	2530.03	2510.03	2530.R3	2510.R3
1250x250mm	2531.03	2511.03	2531.R3	2511.R3

## SE DEPORTE AU BRAQUAGE

## ZWENKT UIT / SE DEPORTE

	Alu 1,5mm - Fluo-rood/rouge	Alu 1,5mm - Fluo-rood/rouge
1000x160mm	2510.04	2510.15
1250x250mm	2511.04	2511.15

## OPGEPAST ZWENKT UIT

## SE DEPORTE AU BRAQUAGE

	Alu 1,5mm - Fluo-rood/rouge	Alu 1,5mm - Fluo-rood/rouge
700x300mm	2512.03	2512.04

## Markeringsbord overhangende last

## Panneau de marquage charge excédentaire

75mm

Folie klasse I  
Film classe I

500x500mm	Boring Trous	RD/WT RETROREFLECT. RGE/BLC RETROREFLECH.	WT RETROREFLECT. BLC RETROREFLECH.	RD RETROREFLECT. RGE RETROREFLECH.
PP - 1,5mm	2x 11,5mm	2121.00	2124.01	2124.02
Alu - 1,5mm	2x 11,5mm	2112.00		
Vin.		2131.00	2134.01	2134.02
Magn. - 1,5mm		2151.00		

Folie klasse II  
Film classe II

Links

Rechts

100mm

Folie klasse III  
Film classe III

282x282mm

423x423mm

846x141mm

282x564mm

	RD/WT RETROREFLECT. RGE/BLC RETROREFLECH.		RD/WT RETROREFLECT. RGE/BLC RETROREFLECH.		RD/WT RETROREFLECT. RGE/BLC RETROREFLECH.			RD/WT RETROREFLECT. RGE/BLC RETROREFLECH.		
	L/R	R/V	L/R	R/V	Links	Rechts	R/V	Links	Rechts	R/V
Vin.	2138.00		2135.00		2136.01	2136.02		2137.01	2137.02	
PP 1,5mm			2125.00		2126.01	2126.02		2127.01	2127.02	
Staal/acier 1mm	2168.00	21K8.00	2115.00	21J5.00	2116.01	2116.02	21J6.00	2117.01	2117.02	21J7.00
Alu 2mm	2118.00	21J8.00								

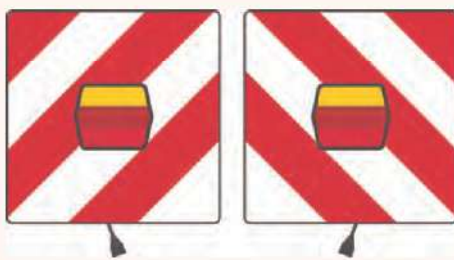

Overlastborden met LED systeem - Enkelzijdig folie  
Met weerstand gemonteerd - LED 12V + 7 mtr. kabelset  
Voor bevestiging op de achterzijde

KL.II	423x423mm
Staal/acier 1mm	2145.00

Panneaux charges excédentaires avec système LED  
Film simple face - Montage avec contre-balance  
LED 12V + 7 mtrs. cable - Pour fixations sur l'arrière

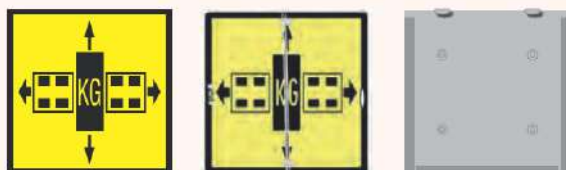

KG-Bord - Geel retroréfl. - KL I - 500x500mm  
Pann. KG - Jaune rétroréfl. - CL I - 500x500mm

Plaathouder + 2 schuifclips  
Support panneau + 2 clips glissants

Vin.	2737.03
Alu - 2mm	2717.03
Alu - 2mm - Vertic.scham./Articul.vertic.	2718.01
Alu - 2mm - Horiz.scham./Articul.horiz.	2718.02
Magn. - 1,5mm - Retrorefl.-KL I / Rétroréfl.-CL I	2757.03
Plaathouder / Supp. pann. - Inox - 0,8mm	264K.00

## werkverkeer

## werkverkeer

	300x60mm	600x120mm	1000x200mm	1500x300mm
Alu - 1,5mm - Retrorefl.-KL I / Rétroréfl.-CL I		2512.05		
Alu - 2mm - Retrorefl.-KL I / Rétroréfl.-CL I			2519.05	251A.05
Vin. - Retrorefl.-KL I / Rétroréfl.-CL I	253F.05		2539.05	253A.05
Vin. - Retrorefl.-KL II / Rétroréfl.-CL II				253B.05
Magn. - 1,5mm - Retrorefl.-KL I / Rétroréfl.-CL I		2502.05		
PP - 1,5mm		2522.05		
PP - 1,5mm + 2 zuign. / 2 vent. - B16201	2541.05	2542.05		

## Interventielampen

## Lampes d'intervention



MAXI5

LED tweezijdig - dagslaper  
Functie flinkerend & statisch  
2 batterijen 4R256V nodig

LED double face - photocell  
Fonction clignotante & statique  
2 batteries 4R256V nécessaires



MAXI6

LED L6 tweezijdig - dagslaper  
Functie flinkerend & statisch  
2 batterijen 4R256V nodig

LED L6 double face - photocell  
Fonction clignotante & statique  
2 batteries 4R256V nécessaires



MAXI7

LED L8L tweezijdig-dagflitser  
Functie flinkerend  
2 batterijen 4R256V nodig

LED L8L double face-non-photocell  
Fonction clignotante  
2 batteries 4R256V nécessaires



MAXI8

LED L3 tweezijdig - dagslaper  
Functie flinkerend  
1 batterij 4R256V nodig

LED L3 double face - photocell  
Fonction clignotante  
1 batterie 4R256V nécessaire



MICRO1

LED lamp - dagflitser  
Functie flinkerend  
1 batterij 4R256V nodig

LED lampe - non-photocell  
Fonction clignotante  
1 batterie 4R256V nécessaire



MKEY1



4R256V

MAXI5	MAXI6	MAXI7	MAXI8	MICRO1
Sleutel / Clé	MKEY1	MKEY1	MKEY1	
Batterij / Batterie	4R256V	4R256V	4R256V	4R256V

## Zwaailichten

## Feux-gyrophares

Diverse bevestigingen mogelijk  
Lamp en bevestiging samen geleverd

EUROROT

Différentes fixations possibles  
Lampe et fixation livrée ensemble



	Op voet Sur pied	Vast met 3 vijzen Fixation par 3 vis	Centrale vijs Vis centrale	Flexibel Flexible	Magnetisch Magnétique	Magnetisch met zuignap Magnétique avec ventouse
12V	GDO75260	GDO75262	GDO75281	GDO75266	GDO75264	GDO75268
24V	GDO75261	GDO75263	GDO75282	GDO75267	GDO75265	GDO75269



ROTOR LIGHT

- 9 verschillende functies
- 16 LED's / rotor light
- waterdicht tot op 10 m diepte & drijft
- zeer stevig
- magnetische bevestiging
- CE & ROHS gecertificeerd



ROTOR1

6x oranje LED + koffer  
6x LED orange + valise



ROTOR2

6x geel LED + koffer  
6x LED jaune + valise

- 9 fonctions différentes
- 16 LED / lumière de rotor
- imperméable jusqu'à une profondeur de 10 m et flotte
- très ferme
- attachement magnétique
- certifié CE et ROHS

Magnetische voet tot 200km/u  
Rubberen basis met antikrasrand en zuignap  
Sterke lichtkoepel in polycarbonaat  
Afmetingen: 120x121x120mm

Pied magnétique jusqu'à 200km/h  
Base en caoutchouc avec bord anti-rayure et ventouse  
Dôme solide en polycarbonate  
Dimension: 120x121x120mm



	Oranje / Orange
12V	GDO12VH10
24V	GDO24VH10

## Reflectoren

## Réflecteurs



Enkelzijdige reflector met afgeronde hoeken  
Diverse kleuren mogelijk  
2 gaten zonder bevestigingen

Réflecteur simple face avec coins arrondis  
Différents coloris possibles  
2 trous sans fixations

	Wit / Blanc	Rood / Rouge	Oranje / Orange	Groen / Vert
120x80mm	2668.01	2668.02	2668.03	2668.04
180x40mm	2669.01	2669.02	2669.03	2669.04

## Kegels

## Cônes



30cm - 0,3kg  
PVC soepel  
Niet reflecterend

30cm - 0,3kg  
PVC souple  
Non-rétro réfléchissant

K0030



50cm - 1,8kg  
Polyethyleen  
Reflecterend Klasse I

50cm - 1,8kg  
Polyéthylène  
Rétro réfléchissant Classe I

K0050A



50cm - 1,8kg  
Polyethyleen  
Reflecterend Klasse I

50cm - 1,8kg  
Polyéthylène  
Réflectissant Classe I

K0050E



50cm - 2,7kg  
Gerecycleerde PVC  
Reflecterend Klasse I

50cm - 2,7kg  
PVC recyclée  
Rétro réfléchissant Classe I

K0050B



50cm - 3kg  
Top: PVC - Voet: Gerecycleerde kunststof  
Reflecterend Klasse II

50cm - 3kg  
Pointe: PVC - Pied: Mat. Synthétique recyclée  
Rétro réfléchissant Classe II

K0050C



75cm - 3,0kg  
Polyethyleen  
Reflecterend Klasse I

75cm - 3,0kg  
Polyéthylène  
Rétro réfléchissant Classe I

K0075A



75cm - 4,8kg  
Gerecycleerde PVC  
Reflecterend Klasse I

75cm - 4,8kg  
PVC recyclée  
Rétro réfléchissant Classe I

K0075B



75cm - 4,2kg  
Top: PVC - Voet: Gerecycleerde kunststof  
Reflecterend Klasse II

75cm - 4,2kg  
Pointe: PVC - Pied: Mat. Synthétique recyclée  
Rétro réfléchissant Classe II

K0075C



Reflecterende strook + geïntegreerd licht  
Bande réfléchissante + lumière intégrée

45cm K0046  
70cm K0070



Lamp voor plooibare kegels K0046 en K0070  
Lampe pour cones repliable K0046 en K0070

K0203

Vergeet niet om het gewenste  
symbool op te geven!  
N'oubliez pas d'indiquer  
le symbole choisi!



30cm - 1,1kg  
Polyethyleen  
Niet-reflecterend

30cm - 1,1kg  
Polyéthylène  
Non-réfléchissant

K00302



45cm - 1,8kg  
Polyethyleen  
Niet-reflecterend

45cm - 1,8kg  
Polyéthylène  
Non-réfléchissant

K00452



75cm - 4,6kg  
Polyethyleen  
Niet-reflecterend

75cm - 4,6kg  
Polyéthylène  
Non-réfléchissant

K00762



56cm - 2,8kg  
Top: polyethyleen  
Voet: gerecycleerde pvc  
Niet-reflecterend

56cm - 2,8kg  
Pointe: polyéthylène  
Pied: pvc recyclé  
Non-réfléchissant

K0056A

K0056

K0056MT



100cm - 7,0kg  
Top: Polyethyleen - Voet: Gerecycleerde PVC  
Reflecterend Klasse I

100cm - 7,0kg  
Pointe: Polyéthylène - Pied: PVC recyclée  
Rétro réfléchissant Classe I

K0100

# TRANSPORT-VERPAKKING

# TRANSPORT-EMBALLAGE

TRANSPORT-EMBALLAGE

## BENZINE

## DIESEL

## MAZOUT

## 2-TAKT

## 7 BAR

## ESSENCE

## LOODVRIJ

	VIN.	VIN.	VIN.	VIN.	VIN.	VIN.
70x30mm	9432.01	9432.02	9432.03	9432.04	9432.05	9432.06
						9432.10



	VIN.	VIN.	VIN.	VIN.	VIN.
Ø35mm	9432.14	9432.15	35x35mm 9432.17	9432.21	9432.22



	VIN.	VIN.	Dibond 3mm
110x80mm	9431.01	9431.00	650x650mm 9416.MT
150x110mm	9434.01		



Vin.Refl. KL I						
200x150mm	94R4.25	94R4.26	94R4.27	94R4.28	94R4.29	94R4.30
297x210mm	94R5.25	94R5.26	94R5.27	94R5.28	94R5.29	94R5.30



Vin.Refl. KL I						
200x150mm	94R4.31	94R4.32	94R4.33	94R4.34	94R4.35	94R4.36
297x210mm	94R5.31	94R5.32	94R5.33	94R5.34	94R5.35	94R5.36



Vin.Refl. KL I	
200x150mm	94R4.37
297x210mm	94R5.37



	PP	VIN.	PP + zuignappen / ventouses	VIN.
40x60mm	9522.00	9532.00		113x77mm 9331.01
100x130mm		9533.00	952A.00	170x110mm 9332.01



	PP	VIN.	Greenline	PP	VIN.	PP	VIN.
35x70mm	1327.01	1337.01		1327.02	1337.02	35x70mm	1337.04
40x100mm	1328.01	1338.01	13U8.01	1328.02	1338.02	50x100mm	1338.04
80x200mm	1329.01	1339.01		1329.02	1339.02	80x200mm	1329.04
140x300mm	1322.01	1332.01		1322.02	1332.02		

TRANSPORT-VERPAKKING

# TRANSPORT-VERPAKKING

## Verpakkingsetiketten

# TRANSPORT-EMBALLAGE

## Etiquettes d'emballage

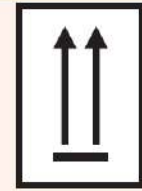
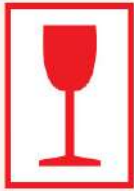

VIN.		VIN.		VIN.		VIN.		VIN.	
50x50mm	1235.09	100x100mm	1231.64	120x110mm	1230.1E	105x74mm	1232.41	74x105mm	1230.08
74x105mm	1230.09	250x250mm	2634.64	180x170mm	1232.1E	340x215mm	1233.41	148x210mm	1232.08
148x210mm	1232.09	300x300mm	2631.64						

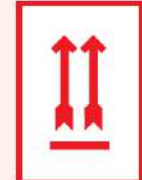

VIN.		VIN.		VIN.		VIN.		VIN.	
70x90mm	1230.07	105x74mm	1232.42	165x55mm	1230.49	105x60mm	1235.46	74x105mm	1230.13
148x210mm	1232.07								



VIN.		VIN.		VIN.		VIN.		VIN.	
60x135mm	1230.43	60x135mm	1230.44	55x30mm	1235.47	74x105mm	1230.06	110x90mm	1230.40



VIN.		VIN.		VIN.		VIN.		VIN.	
60x40mm	1230.51	200x100mm	1232.50	75x105mm	1230.53	100x100mm	1230.45		1230.4F

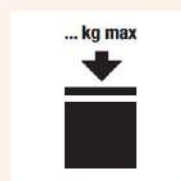

VIN.		VIN.		VIN.		VIN.		VIN.	
100x100mm	1230.15		1230.52		1230.3F		1230.7F		1230.48



VIN.		VIN.		VIN.		VIN.	
100x100mm	1230.TIMT		1230.93	200x60mm	1230.2D	150x250mm	1236.MT



VIN. 1000x rol/roul  
100x100mm 12N1.48



VIN. 1000x rol/roul  
100x100mm 12N1.89

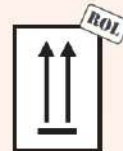

VIN. 1000x rol/roul  
100x100mm 12N1.88



VIN. 1000x rol/roul  
100x100mm 12N1.99



VIN. 1000x rol/roul  
100x100mm 12N1.64



VIN. 1000x rol/roul  
100x100mm 12N1.92N



VIN.  
120x110mm 1230.LIMIT



VIN. 1000x rol/roul  
100x100mm 12N1.2F



VIN. CRACKBACK  
105x74mm 1230.54



VIN. CRACKBACK  
100x100mm 2630.92N



VIN. 1000x rol/roul  
120x110mm 12N1.50



VIN.  
200x50mm 1230.3B



VIN.  
1230.8A



VIN.  
1230.9A



VIN.  
1230.4B



VIN.  
200x50mm 1230.5B



VIN.  
1230.7B



VIN.  
1230.6A



VIN.  
1230.9B



VIN.  
200x50mm 1230.8B



VIN.  
1230.3A



VIN.  
1230.7A



VIN.  
1230.2C



VIN.  
200x50mm 1230.9D



VIN.  
1230.4E



VIN.  
1230.5E



VIN.  
1230.2A



VIN.  
200x50mm 1230.3E



VIN.  
1230.8D



VIN.  
1230.6D



VIN.  
1230.9E



VIN.  
200x50mm 1230.8E



VIN.  
1230.3D



VIN.  
1230.7D



VIN.  
1230.2F

**GHS**

Wereldwijd Geharmoniseerd Systeem (Global Harmonized System) voor de indeling en de etikettering van chemische stoffen.

**SGH**

Système Général Harmonisé pour la classification et l'étiquetage des produits chimiques.

71		<b>GHS01</b> <b>SGH01</b>	Ontpofbare stoffen <i>Matières explosives</i>
72		<b>GHS02</b> <b>SGH02</b>	Ontvlambare stoffen <i>Matières solides inflammables</i>
73		<b>GHS03</b> <b>SGH03</b>	Oxiderende stoffen <i>Matières comburantes</i>
74		<b>GHS04</b> <b>SGH04</b>	Gashouder onder druk <i>Matières gazeuses sous pression</i>
75		<b>GHS05</b> <b>SGH05</b>	Corrosieve stoffen <i>Matières corrosives</i>
76		<b>GHS06</b> <b>SGH06</b>	Giftige stoffen <i>Matières toxiques</i>
77		<b>GHS07</b> <b>SGH07</b>	Gevaar voor sensibilisatie van de huid, bij het inademen, schadelijk of irriterend voor de ogen <i>Danger pour sensibilisation cutanée, inhalation, corrosion ou irritation des yeux</i>
78		<b>GHS09</b> <b>SGH09</b>	Schadelijk voor het aquatisch milieu <i>Danger pour le milieu aquatique</i>
79		<b>GHS08</b> <b>SGH08</b>	Mutageen, ademhalings, kankerverwekkend of reproductierisico <i>Risques mutagènes, respiratoires, cancérigènes ou pour la reproduction</i>

# CLP-ETIKETTERING Gevaarlijke stoffen

# ETIQUETAGE CLP Produits dangereux

Vierkant met wit kader

Carré avec cadre blanc



54 stuks per vel/pièces par feuille	PP											
15x15mm	VIN	113F.71	113F.72	113F.73	113F.74	113F.75	113F.76	113F.77	113F.78	113F.79		
Magneet/Aimant 0.6mm												
25 stuks per vel/pièces par feuille	PP											
25x24mm	VIN	1136.71	1136.72	1136.73	1136.74	1136.75	1136.76	1136.77	1136.78	1136.79		
Magneet/Aimant 0.6mm												
25 stuks per vel/pièces par feuille	PP											
34x34mm	VIN	1137.71	1137.72	1137.73	1137.74	1137.75	1137.76	1137.77	1137.78	1137.79		
Magneet/Aimant 0.6mm												
47x47mm	VIN	1138.71	1138.72	1138.73	1138.74	1138.75	1138.76	1138.77	1138.78	1138.79		
Magneet/Aimant 0.6mm												
50x50mm	PP											
	VIN	113C.71	113C.72	113C.73	113C.74	113C.75	113C.76	113C.77	113C.78	113C.79		
Magneet/Aimant 0.6mm												
100x100mm	PP	112D.71	112D.72	112D.73	112D.74	112D.75	112D.76	112D.77	112D.78	112D.79		
	VIN	113D.71	113D.72	113D.73	113D.74	113D.75	113D.76	113D.77	113D.78	113D.79		
Magneet/Aimant 0.6mm												
150x150mm	PP	112L.71	112L.72	112L.73	112L.74	112L.75	112L.76	112L.77	112L.78	112L.79		
	VIN	113L.71	113L.72	113L.73	113L.74	113L.75	113L.76	113L.77	113L.78	113L.79		
Magneet/Aimant 0.6mm												
250x250mm	PP	112E.71	112E.72	112E.73	112E.74	112E.75	112E.76	112E.77	112E.78	112E.79		
	VIN	113E.71	113E.72	113E.73	113E.74	113E.75	113E.76	113E.77	113E.78	113E.79		
Magneet/Aimant 0.6mm		110E.71	110E.72	110E.73	110E.74	110E.75	110E.76	110E.77	110E.78	110E.79		
300x300mm	PP	112K.71	112K.72	112K.73	112K.74	112K.75	112K.76	112K.77	112K.78	112K.79		
	VIN	113K.71	113K.72	113K.73	113K.74	113K.75	113K.76	113K.77	113K.78	113K.79		
Magneet/Aimant 0.6mm		110K.71	110K.72	110K.73	110K.74	110K.75	110K.76	110K.77	110K.78	110K.79		

Ruitvormig zonder wit kader

Losangique sans cadre blanc



24x24mm	VIN	1136.A0	1136.A1	1136.A2	1136.A3	1136.A4	1136.A5	1136.A6	1136.A7	1136.A8
34x34mm		1137.A0	1137.A1	1137.A2	1137.A3	1137.A4	1137.A5	1137.A6	1137.A7	1137.A8
100x100mm		113D.A0	113D.A1	113D.A2	113D.A3	113D.A4	113D.A5	113D.A6	113D.A7	113D.A8
250x250mm		113E.A0	113E.A1	113E.A2	113E.A3	113E.A4	113E.A5	113E.A6	113E.A7	113E.A8

Zelfklevers op rol

Autocollants sur rouleaux

Vinyl - Glanzend - Permanente lijm - Per rol van 1000 stuks

Vinyle - Brillant - Colle permanente - Par rouleau de 1000 pièces



15x15mm	VIN	12N2.71	12N2.72	12N2.73	12N2.74	12N2.75	12N2.76	12N2.77	12N2.78	12N2.79
25x25mm		12N3.71	12N3.72	12N3.73	12N3.74	12N3.75	12N3.76	12N3.77	12N3.78	12N3.79
50x50mm		12N4.71	12N4.72	12N4.73	12N4.74	12N4.75	12N4.76	12N4.77	12N4.78	12N4.79
100x100mm		12N5.71	12N5.72	12N5.73	12N5.74	12N5.75	12N5.76	12N5.77	12N5.78	12N5.79

## Etikettendispensers

## Distributeurs étiquettes

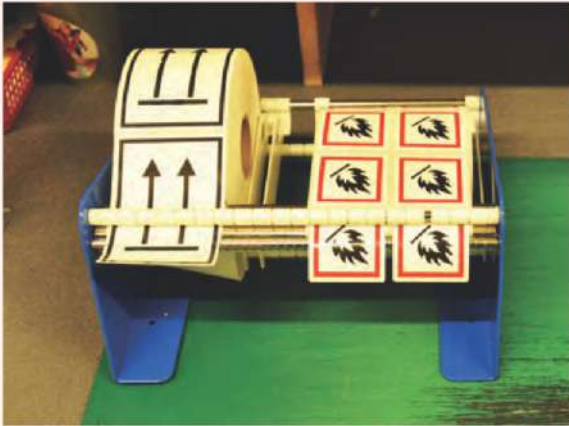

- Metalen behuizing
- Tafelmodel
- Diverse breedtes
- Boëtier en métal
- Modèle table
- Différentes largeurs

Rollbreedte Largeur rouleaux	Tussenschotten Cloisons	
Max.75mm	0	6815
Max.100mm	0	6816
Max.150mm	2	6817
Max.250mm	3	6819
Max.300mm	4	6820

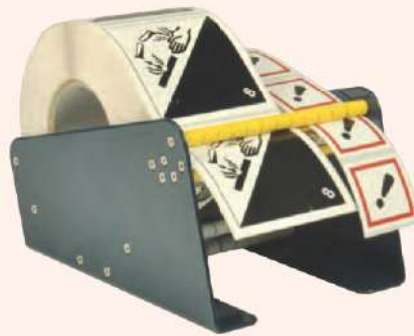

## Verpakkingstape

## Ruban d'emballage

Polypropyleen 23 micron - Zelfklevend

Polypropylène 23 micron - Adhésif



Rol / Rouleau

48mm x 66m TA3102

TA3105

TA3108



Rol / Rouleau

48mm x 66m TA3103

TA3106

TA3109



Rol / Rouleau

48mm x 66m TA3104

TA3107

TA3110

**BREEKBAAR**  **BREEKBAAR**

**FRAGILE**  **FRAGILE**

Rol / Rouleau

48mm x 66m TA3011

TA3012

**BREEKBAAR  
FRAGILE** 

**BREEKBAAR  
FRAGILE**



Rol / Rouleau

48mm x 66m TA3001

TA3013



Vanaf 72 rollen met eigen tekst en/of logo  
Zelfklevende PP - 48mmx66meter / Rol

A partir de 72 rouleaux avec votre propre texte et/ou logo  
PP adhésif - 48mmx66mètres / Rouleau

# CLP-ETIKETTERING Gevaarlijke stoffen

# ETIQUETAGE CLP Produits dangereux

## Etiketten met tekst

## Etiquettes avec texte



VIN.	
50x70	1138.80
120x170	113G.80
150x210	113E.80



VIN.	
50x70	1138.81
120x170	113G.81
150x210	113E.81



VIN.	
50x70	1138.82
120x170	113G.82
150x210	113E.82



VIN.	
50x70	1138.83
120x170	113G.83
150x210	113E.83



VIN.	
50x70	1138.84
120x170	113G.84
150x210	113E.84



VIN.	
50x70	1138.85
120x170	113G.85
150x210	113E.85



VIN.	
50x70	1138.86
120x170	113G.86
150x210	113E.86



VIN.	
50x70	1138.87
120x170	113G.87
150x210	113E.87



VIN.	
50x70	1138.88
120x170	113G.88
150x210	113E.88



VIN.	
50x70	1138.89
120x170	113G.89
150x210	113E.89



VIN.	
50x70	1138.90
120x170	113G.90
150x210	113E.90



VIN.	
50x70	1138.91
120x170	113G.91
150x210	113E.91



VIN.	
50x70	1138.92
120x170	113G.92
150x210	113E.92



VIN.	
50x70	1138.93
120x170	113G.93
150x210	113E.93

**Signaalwoord**  
Mot-clé

**GEVAAR**

**Symbolen**  
Symboles

**Productnaam of codes\***  
Nom ou identifiants du produit\*

**H-zinnen**  
Mentions de danger

**P-zinnen**  
Mentions de prudence

**Gegevens van de fabrikant**  
Informations relatives au fabricant

\*Bijkomende productcodes  
\*Identifiants supplémentaires du produit

**Koolmonoxide**

H220: Zeer licht ontvlambaar gas. – H331: Giftig bij inademing. – H360D: Kan het ongeboren kind schaden. – H372: Veroorzaakt schade aan organen bij langdurige of herhaalde blootstelling

P233: In goed gesloten verpakking bewaren. P304 + P340: Voorkom inademen van dampen. Bij inademing P403: Persoon in de frisse lucht brengen en ervoor zorgen dat deze gemakkelijk kan ademen. Een antitoxicentrum of arts raadplegen. Op een goed geventileerde plaats bewaren.

30,0l

36049-0 211-126-3 006-001-00-2 4444 05 238 38 83

VIN.	
74x52	133A.MT
105x74	133B.MT
148x105	133C.MT
210x148	133D.MT

74x52mm	<3 liter <3 litres
105x74mm	van 3 tot 50 liter De 3 à 50 litres
148x105mm	van 50 tot 500 liter De 50 à 500 litres
210x148mm	>500 liter >500 litres

# CLP-ETIKETTERING GEVAARLIJKE STOFFEN ETIQUETAGE CLP PRODUITS DANGEREUX

Etiketten met tekst

Etiquettes avec texte

ETIQUETAGE CLP - PRODUITS DANGEREUX

CLP-ETIKETTERING - GEVAARLIJKE STOFFEN



Danger

VIN.



Attention

VIN.



Danger

VIN.



Attention

VIN.



Danger

VIN.

50x70mm	1138.B0	1138.B1	1138.B2	1138.B3	1138.B4
120x170mm	113G.B0	113G.B1	113G.B2	113G.B3	113G.B4
150x210mm	113E.B0	113E.B1	113E.B2	113E.B3	113E.B4



Attention

VIN.



Danger

VIN.



Attention

VIN.



Danger

VIN.



Attention

VIN.

50x70mm	1138.B5	1138.B6	1138.B7	1138.B8	1138.B9
120x170mm	113G.B5	113G.B6	113G.B7	113G.B8	113G.B9
150x210mm	113E.B5	113E.B6	113E.B7	113E.B8	113E.B9



Attention

VIN.



Danger

VIN.



Attention

VIN.



Attention

VIN.

50x70mm	1138.C0	1138.C1	1138.C2	1138.C3
120x170mm	113G.C0	113G.C1	113G.C2	113G.C3
150x210mm	113E.C0	113E.C1	113E.C2	113E.C3

## NFPA Gevarendiamant

## NFPA Diamant du feu



Betekenis kleuren:  
**Blauw:** Gezondheid  
**Rood:** Ontvlambaarheid en explosiviteit  
**Geel:** Stabiliteit en reactiviteit  
**Wit:** Bijzondere aanduidingen

Indication couleurs:  
**Bleu:** Santé  
**Rouge:** Inflammabilité et explosivité  
**Jaune:** Instabilité et réactivité  
**Blanc:** Risque spécifique

Vergeet niet bij bestellingen MT de klasscijfers door te geven

N'oubliez pas de noter les chiffres de classe sur votre commandes MT



voorbeeld  
 exemple

VIN.		VIN.	
100x100mm	2636.01	100x100mm	2636.01MT
250x250mm	2634.01	250x250mm	2634.01MT
300x300mm	2638.01	300x300mm	2638.01MT

**HEALTH HAZARD** Flank Points:  
 4: Deathly  
 3: Serious Danger  
 2: Hazardous  
 1: Slightly Hazardous  
 0: Not a Material

**FIRE HAZARD** Flank Points:  
 4: Below 73°F  
 3: Below 100°F  
 2: Below 200°F  
 1: Above 200°F  
 0: Will Not Burn

**INSTABILITY**  
 4: May Detonate  
 3: Shock - Mass may Detonate  
 2: Violent Chemical Change  
 1: Unstable if Heated  
 0: Stable

**SPECIFIC HAZARD**  
 Ox: Oxidizer    AD: Acid  
 Alk: Alkaline    CC: Corrosive  
 W: Water Reactive    \*+\*: Explosive  
 SA: Simple Asphyxiant

CONSULT SDS FOR FURTHER INSTRUCTIONS

RATING EXPLANATION GUIDE		
HEALTH	FLAMMABLE	INSTABILITY
Recommended Protection	Susceptibility to Burning	Susceptibility to Energy Release
<b>4</b> Special full protective suit and breathing apparatus must be worn.	<b>4</b> Very Flammable.	<b>4</b> May detonate under normal conditions.
<b>3</b> Full protective suit and breathing apparatus should be worn.	<b>3</b> Ignites under normal temperature conditions.	<b>3</b> May detonate with shock or heat.
<b>2</b> Breathing apparatus with full face mask should be worn.	<b>2</b> Ignites with moderate heating.	<b>2</b> Violent chemical change but does not detonate.
<b>1</b> Breathing apparatus may be worn.	<b>1</b> Ignites when heated.	<b>1</b> Not stable if heated; use precautions.
<b>0</b> No precautions necessary.	<b>0</b> Will not ignite.	<b>0</b> Normally stable.

# LEIDINGMARKERING

Product INFO:

Eco-digital

Bescherming tegen UV.

# MARQUAGE DE TUYAUTERIES

INFO produit:

Eco-digital

Protégé contre rayons UV.

RAL 1004	Gassen / Gaz
RAL 3000	Blusleidingen / Incendie
RAL 5012	Lucht / Air
RAL 6010	Water / Eau
RAL 9005	Ontvlambare vloeistoffen / Liquides non inflammables
RAL 8001	Ontvlambare vloeistoffen / Liquides inflammables
RAL 9006	Stoom / Vapeur
RAL 4001	Zuren & Basen / Acides & Bases
RAL 2008	Zuren / Acides



**GHS01 / SGH01**

Ontploffbare stoffen  
Matières explosives



**GHS02 / SGH02**

Ontvlambare stoffen  
Matières solides inflammables



**GHS03 / SGH03**

Oxiderende stoffen  
Matières comburantes



**GHS04 / SGH04**

Gashouder onder druk  
Matières gazeuses sous pression



**GHS05 / SGH05**

Corrosieve stoffen  
Matières corrosives



**GHS06 / SGH06**

Giftige stoffen  
Matières toxiques



**GHS07 / SGH07**

Gevaar voor sensibilisatie van de huid bij het inademen, schadelijk of irriterend voor de ogen.  
Danger pour sensibilisation cutanée, inhalation, corrosion ou irritation des yeux.



**GHS08 / SGH08**

Mutageen, ademhalings, kankerverwekkend of reproductierisico.  
Risques mutagènes, respiratoires, cancérigènes ou pour la reproduction.



**GHS09 / SGH09**

Schadelijk voor het aquatisch milieu  
Danger pour le milieu aquatique

MET UW EIGEN TEKST / SYMBOLEN  
AVEC VOTRE PROPRE TEXTE / SYMBOLES



Voeg "MT" toe na de eerste 4 karakters,  
vb: "1966.MT"

Ajoutez "MT" après les premiers 4 caractères,  
ex: "1966.MT"



# LEIDINGMARKERING

Voorbeelden, fragment op ware grootte

# MARQUAGE DE TUYAUTERIES

Fragment des exemples sur grandeur réelle



150x12mm  
per/par10



250x26mm  
per/par3



355x37mm  
per/par3













































































450x52mm  
per/par2

MARQUAGE DE TUYAUTERIES

LEIDINGMARKERING

# LEIDINGMARKERING





# MARQUAGE DE TUYAUTERIES

Tekst / Texte	GHS / SGH	Signaalwoord Avertissement	150x12mm Vel / File 10st/pc	250x26mm Vel / File 3st/pc	355x37mm Vel / File 3st/pc	450x52mm Vel / File 2st/pc
<b>Gassen / Gaz</b>						
Aanvoer			19M201	196201	197201	198201
Aardgas		GEVAAR	19M202	196202	197202	198202
Aardgas HD		GEVAAR	19M266	196266	197266	198266
Aardgas LD		GEVAAR	19M267	196267	197267	198267
Acetyleen		GEVAAR	19M203	196203	197203	198203
Acétylène		DANGER	19M204	196204	197204	198204
Afgas			19M268	196268	197268	198268
Afvoer			19M205	196205	197205	198205
Aller			19M281	196281	197281	198281
Ammoniac	 	DANGER	19M206	196206	197206	198206
Ammoniak	 	GEVAAR	19M207	196207	197207	198207
Ammoniakgas	 	GEVAAR	19M269	196269	197269	198269
Argon		WAARSCHUWING	19M208	196208	197208	198208
Atal		ATTENTION	19M282	196282	197282	198282
Azote		ATTENTION	19M209	196209	197209	198209
Azote évaporée	 	DANGER	19M262	196262	197262	198262
Azote gazeux		ATTENTION	19M283	196283	197283	198283
Biogas	 	GEVAAR	19M210	196210	197210	198210
Biogaz	 	DANGER	19M284	196284	197284	198284
Brandgas	  	GEVAAR	19M265	196265	197265	198265
Butaan	 	GEVAAR	19M211	196211	197211	198211
Butane	 	DANGER	19M285	196285	197285	198285
Butanol	  	DANGER	19M286	196286	197286	198286
Butène	 	DANGER	19M287	196287	197287	198287
Chloor	 	GEVAAR	19M212	196212	197212	198212
Chloortrifluormethaan		GEVAAR	19M270	196270	197270	198270
Chlore	  	DANGER	19M288	196288	197288	198288
CO	  	GEVAAR	19M2109	1962109	1972109	1982109
CO	  	DANGER	19M213	196213	197213	198213
CO2		WAARSCHUWING	19M214	196214	197214	198214
CO2 gas		WAARSCHUWING	19M271	196271	197271	198271
Condensaat		GEVAAR	19M215	196215	197215	198215
Condensat		ATTENTION	19M289	196289	197289	198289
Cyclopropane	 	DANGER	19M290	196290	197290	198290
Dimethylamine	  	GEVAAR	19M272	196272	197272	198272
Droog stikstofgas		WAARSCHUWING	19M273	196273	197273	198273
Echappement		ATTENTION	19M291	196291	197291	198291
Etheen	 	GEVAAR	19M216	196216	197216	198216
Ethyleengas	  	GEVAAR	19M217	196217	197217	198217
Ethyleenoxyde	   	GEVAAR	19M218	196218	197218	198218
Fluor	  	DANGER	19M292	196292	197292	198292
Freon		WAARSCHUWING	19M219	196219	197219	198219
Fréon		ATTENTION	19M220	196220	197220	198220
Freon R 22		WAARSCHUWING	19M274	196274	197274	198274
Fréon R 22		ATTENTION	19M293	196293	197293	198293
Gas		WAARSCHUWING	19M221	196221	197221	198221
Gaz		ATTENTION	19M294	196294	197294	198294
Gaz carbonique		ATTENTION	19M296	196296	197296	198296
Gaz d'ammoniac	  	DANGER	19M295	196295	197295	198295
Gaz de cokerie		DANGER	19M297	196297	197297	198297

MARQUAGE DE TUYAUTERIES

LEIDINGMARKERING

Tekst / Texte	GHS / SGH	Signaalwoord Avertissement	150x12mm Vel / File 10st/pc	250x26mm Vel / File 3st/pc	355x37mm Vel / File 3st/pc	450x52mm Vel / File 2st/pc
Gaz de refroidissement		ATTENTION	19M298	196298	197298	198298
Gaz de ville		DANGER	19M222	196222	197222	198222
Gaz inerte		ATTENTION	19M299	196299	197299	198299
Gaz mixte		ATTENTION	19M2100	1962100	1972100	1982100
Gaz naturel		DANGER	19M223	196223	197223	198223
Gaz naturel BP		DANGER	19M2101	1962101	1972101	1982101
Gaz naturel MP		DANGER	19M2102	1962102	1972102	1982102
Gaz recyclé		ATTENTION	19M2103	1962103	1972103	1982103
Gaz riche		ATTENTION	19M2104	1962104	1972104	1982104
Glycerine			19M275	196275	197275	198275
Glycol		WAARSCHUWING	19M276	196276	197276	198276
GPL		DANGER	19M2105	1962105	1972105	1982105
H2		GEVAAR	19M2110	1962110	1972110	1982110
H2		DANGER	19M224	196224	197224	198224
H2S		GEVAAR	19M2111	1962111	1972111	1982111
H2S		DANGER	19M225	196225	197225	198225
Helium		WAARSCHUWING	19M226	196226	197226	198226
Hélium		ATTENTION	19M227	196227	197227	198227
Hoogovengas			19M277	196277	197277	198277
Hydrogène		DANGER	19M228	196228	197228	198228
Inert-gas		WAARSCHUWING	19M278	196278	197278	198278
Koelgas			19M279	196279	197279	198279
Kooldioxide			19M229	196229	197229	198229
Koolstofdioxide			19M230	196230	197230	198230
Koolzuurgas			19M280	196280	197280	198280
Lachgas		GEVAAR	19M231	196231	197231	198231
LPG		GEVAAR	19M232	196232	197232	198232
Menggas			19M264	196264	197264	198264
Methaan		GEVAAR	19M233	196233	197233	198233
Méthane		DANGER	19M2106	1962106	1972106	1982106
Methanol		GEVAAR	19M234	196234	197234	198234
Méthanol		DANGER	19M235	196235	197235	198235
Mise à l'air		DANGER	19M263	196263	197263	198263
NH3		GEVAAR	19M2112	1962112	1972112	1982112
NH3		DANGER	19M236	196236	197236	198236
Oxyde d'éthylène		DANGER	19M237	196237	197237	198237
Oxyde de carbone		ATTENTION	19M2107	1962107	1972107	1982107
Oxygène		DANGER	19M238	196238	197238	198238
Ozone		ATTENTION	19M2108	1962108	1972108	1982108
Pentaaan		GEVAAR	19M239	196239	197239	198239
Pentane		DANGER	19M240	196240	197240	198240
Propaan		GEVAAR	19M241	196241	197241	198241
Propadiëne		ATTENTION	19M242	196242	197242	198242
Propane		DANGER	19M243	196243	197243	198243
Propeen		GEVAAR	19M244	196244	197244	198244
Propyleen		GEVAAR	19M245	196245	197245	198245
Propylène		DANGER	19M246	196246	197246	198246
Restgas			19M247	196247	197247	198247
Retour		ATTENTION	19M248	196248	197248	198248
Reukloos aardgas		GEVAAR	19M261	196261	197261	198261
Rookgas			19M249	196249	197249	198249
Stikstof		WAARSCHUWING	19M250	196250	197250	198250

Tekst / Texte	GHS / SGH	Signaalwoord Avertissement	150x12mm Vel / File 10st/pc	250x26mm Vel / File 3st/pc	355x37mm Vel / File 3st/pc	450x52mm Vel / File 2st/pc
Vacuum			19M251	196251	197251	198251
Vacuüm			19M252	196252	197252	198252
Vacuümleiding			19M253	196253	197253	198253
Verbrandingsgas			19M254	196254	197254	198254
Vide			19M255	196255	197255	198255
Waterstof		GEVAAR	19M256	196256	197256	198256
Zuurstof		GEVAAR	19M257	196257	197257	198257
Zwaveldioxide		GEVAAR	19M258	196258	197258	198258
Zwavelwaterstof		GEVAAR	19M259	196259	197259	198259
<b>Blusleidingen / Incendie</b>						
Blusleiding			19M301	196301	197301	198301
Blusleiding droog			19M320	196320	197320	198320
Blusleiding nat			19M322	196322	197322	198322
Blusschuim			19M302	196302	197302	198302
Bluswater			19M303	196303	197303	198303
Brandbluskoolzuur			19M304	196304	197304	198304
CO2 Blusleiding			19M318	196318	197318	198318
Colonne sèche			19M330	196330	197330	198330
Eau			19M329	196329	197329	198329
Eau incendie			19M305	196305	197305	198305
Eau sprinkler			19M306	196306	197306	198306
Extinction automatique			19M331	196331	197331	198331
Hydrant leiding			19M307	196307	197307	198307
Mousse			19M308	196308	197308	198308
Mousse carbonique			19M309	196309	197309	198309
Réseau incendie			19M323	196323	197323	198323
Réseau incendie CO2			19M319	196319	197319	198319
Réseau incendie sec			19M321	196321	197321	198321
Réseau incendie sous pression			19M310	196310	197310	198310
Réseau sprinkler			19M332	196332	197332	198332
RIA			19M311	196311	197311	198311
Schuim			19M328	196328	197328	198328
Schuimbluswater			19M312	196312	197312	198312
Sprinkler			19M313	196313	197313	198313
Sprinklerwater			19M314	196314	197314	198314
Water			19M327	196327	197327	198327
<b>Onontvlambare vloeistoffen / Liquides non inflammables</b>						
Anti odeurs			19M411	196411	197411	198411
Argon			19M401	196401	197401	198401
Chloroform		WAARSCHUWING	19M402	196402	197402	198402
Emulsion			19M405	196405	197405	198405
Freon 21			19M403	196403	197403	198403
Helium			19M404	196404	197404	198404
<b>Lucht / Air</b>						
Ademhalingslucht			19M501	196501	197501	198501
Ademperslucht			19M540	196540	197540	198540
Afblaaslucht			19M541	196541	197541	198541
Air			19M502	196502	197502	198502
Air 3 bars			19M560	196560	197560	198560

Tekst / Texte	GHS / SGH	Signaalwoord Avertissement	150x12mm	250x26mm	355x37mm	450x52mm
			Vel /File 10st/pc	Vel /File 3st/pc	Vel /File 3st/pc	Vel /File 2st/pc
Air 7 bars			19M561	196561	197561	198561
Air chaud			19M503	196503	197503	198503
Air comprimé			19M504	196504	197504	198504
Air comprimé 1.5 bars			19M562	196562	197562	198562
Air comprimé 3.5 bars			19M563	196563	197563	198563
Air comprimé 6 bars			19M564	196564	197564	198564
Air comprimé stérile			19M565	196565	197565	198565
Air conditionné			19M505	196505	197505	198505
Air de refroidissement			19M506	196506	197506	198506
Air de séchage			19M507	196507	197507	198507
Air d'instrumentation			19M566	196566	197566	198566
Air épuré			19M508	196508	197508	198508
Air extrait			19M509	196509	197509	198509
Air frais			19M539	196539	197539	198539
Air froid			19M510	196510	197510	198510
Air neuf			19M511	196511	197511	198511
Air repris			19M567	196567	197567	198567
Air respirable			19M512	196512	197512	198512
Air sec			19M513	196513	197513	198513
Air soufflé			19M568	196568	197568	198568
Air stérile			19M514	196514	197514	198514
Air supprimé			19M569	196569	197569	198569
Air traité			19M515	196515	197515	198515
Bar			19M516	196516	197516	198516
Buitenlucht			19M517	196517	197517	198517
Compressorlucht			19M518	196518	197518	198518
Comprimé			19M519	196519	197519	198519
Droge lucht			19M520	196520	197520	198520
Drooglucht			19M542	196542	197542	198542
Echappement air			19M521	196521	197521	198521
Extractielucht			19M522	196522	197522	198522
Gesmeerde lucht			19M536	196536	197536	198536
Hete lucht			19M543	196543	197543	198543
Instrumentenlucht			19M523	196523	197523	198523
Koellucht			19M524	196524	197524	198524
Koude lucht			19M525	196525	197525	198525
Lucht			19M526	196526	197526	198526
Meetlucht			19M527	196527	197527	198527
Natte lucht			19M528	196528	197528	198528
Olievrije lucht			19M537	196537	197537	198537
Ontluchting			19M530	196530	197530	198530
Ontstoffingslucht			19M529	196529	197529	198529
Oxygène			19M538	196538	197538	198538
Perslucht			19M531	196531	197531	198531
Perslucht 4 bar			19M548	196548	197548	198548
Perslucht 6 bar			19M549	196549	197549	198549
Perslucht 7 bar			19M550	196550	197550	198550
Perslucht 10 bar			19M545	196545	197545	198545
Perslucht 12 bar			19M546	196546	197546	198546
Perslucht 16 bar			19M547	196547	197547	198547
Perslucht HD			19M551	196551	197551	198551
Perslucht LD			19M552	196552	197552	198552

# LEIDINGMARKERING

# MARQUAGE DE TUYAUTERIES

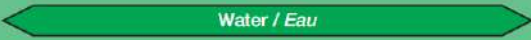
Tekst / Texte	GHS / SGH	Signaalwoord Avertissement	150x12mm Vel / File 10st/pc	250x26mm Vel / File 3st/pc	355x37mm Vel / File 3st/pc	450x52mm Vel / File 2st/pc
Recirculatielucht			19M553	196553	197553	198553
Retour			19M570	196570	197570	198570
Soufflage			19M532	196532	197532	198532
Spoellucht			19M533	196533	197533	198533
Steriele lucht			19M554	196554	197554	198554
Ventilatielucht			19M534	196534	197534	198534
Ventilation primaire			19M571	196571	197571	198571
Verbrandingslucht			19M555	196555	197555	198555
Verdunningslucht			19M556	196556	197556	198556
Vide			19M535	196535	197535	198535
Vloeibare lucht			19M557	196557	197557	198557
Werklucht			19M558	196558	197558	198558
Werkperslucht			19M559	196559	197559	198559
						
Aanvoer			19M601	196601	197601	198601
Aanvoer CV			19M6113	1966113	1976113	1986113
Afvalwater			19M602	196602	197602	198602
Afvoer			19M603	196603	197603	198603
Afvoer CV			19M6114	1966114	1976114	1986114
Afvoerleiding			19M6115	1966115	1976115	1986115
Aller			19M604	196604	197604	198604
Bedrijfswater			19M605	196605	197605	198605
Bluswater			19M606	196606	197606	198606
Boorputwater			19M607	196607	197607	198607
Brak water			19M6116	1966116	1976116	1986116
Brandbluswater			19M608	196608	197608	198608
Bronwater			19M609	196609	197609	198609
Chauffage			19M610	196610	197610	198610
Chauffage aller			19M6151	1966151	1976151	1986151
Chauffage retour			19M6152	1966152	1976152	1986152
Circuit			19M6117	1966117	1976117	1986117
Circuit de récupération			19M6154	1966154	1976154	1986154
Circuit primaire			19M6155	1966155	1976155	1986155
Circuit secondaire			19M6156	1966156	1976156	1986156
Condensaat			19M611	196611	197611	198611
Condensat			19M612	196612	197612	198612
Condensats BP			19M6157	1966157	1976157	1986157
Condensats MP			19M6158	1966158	1976158	1986158
Condenswater			19M613	196613	197613	198613
Demi-water			19M614	196614	197614	198614
Desinfectiewater			19M6118	1966118	1976118	1986118
Drinkwater			19M615	196615	197615	198615
Eau acide			19M617	196617	197617	198617
Eau adoucie			19M618	196618	197618	198618
Eau adoucie chaude			19M6109	1966109	1976109	1986109
Eau adoucie froide			19M6110	1966110	1976110	1986110
Eau brute			19M619	196619	197619	198619
Eau chaude			19M620	196620	197620	198620
Eau chaude 45°C			19M6160	1966160	1976160	1986160
Eau chaude 60°C			19M6161	1966161	1976161	1986161
Eau chaude 70°C			19M6162	1966162	1976162	1986162

Tekst / Texte	GHS / SGH	Signaalwoord Avertissement	150x12mm	250x26mm	355x37mm	450x52mm
			Vel / Ffle 10st/pc	Vel / Ffle 3st/pc	Vel / Ffle 3st/pc	Vel / Ffle 2st/pc
Eau chaude 90°C			19M6163	1966163	1976163	1986163
Eau chaude 105°C			19M6159	1966159	1976159	1986159
Eau chaude adoucie			19M6164	1966164	1976164	1986164
Eau chaude aller			19M6165	1966165	1976165	1986165
Eau chaude chauffage			19M6166	1966166	1976166	1986166
Eau chaude primaire			19M6167	1966167	1976167	1986167
Eau chaude retour			19M6168	1966168	1976168	1986168
Eau chaude sanitaire			19M6169	1966169	1976169	1986169
Eau chaude secondaire			19M6170	1966170	1976170	1986170
Eau chlorée			19M621	196621	197621	198621
Eau clarifloculée			19M6171	1966171	1976171	1986171
Eau condensée			19M622	196622	197622	198622
Eau condenseur			19M6172	1966172	1976172	1986172
Eau condenseur aller			19M6173	1966173	1976173	1986173
Eau condenseur retour			19M6174	1966174	1976174	1986174
Eau d'alimentation			19M623	196623	197623	198623
Eau d'exhaure			19M6175	1966175	1976175	1986175
Eau de chauffage			19M6104	1966104	1976104	1986104
Eau de chauffage aller			19M6177	1966177	1976177	1986177
Eau de chauffage boucle			19M6178	1966178	1976178	1986178
Eau de chauffage retour			19M6179	1966179	1976179	1986179
Eau de chauffe			19M624	196624	197624	198624
Eau de circulation			19M625	196625	197625	198625
Eau de climatisation			19M626	196626	197626	198626
Eau de fabrication			19M627	196627	197627	198627
Eau de forage			19M628	196628	197628	198628
Eau de lavage			19M629	196629	197629	198629
Eau de puits			19M630	196630	197630	198630
Eau de récupération			19M631	196631	197631	198631
Eau de refroidissement			19M632	196632	197632	198632
Eau de rinçage			19M633	196633	197633	198633
Eau de rivière			19M634	196634	197634	198634
Eau de tour			19M635	196635	197635	198635
Eau de vanne			19M636	196636	197636	198636
Eau de ville			19M638	196638	197638	198638
Eau de ville adoucie			19M6108	1966108	1976108	1986108
Eau de ville froide			19M637	196637	197637	198637
Eau décarbonatée			19M6176	1966176	1976176	1986176
Eau déionisée			19M6180	1966180	1976180	1986180
Eau demi map			19M6181	1966181	1976181	1986181
Eau déminéralisée			19M6107	1966107	1976107	1986107
Eau déminéralisée chaude			19M639	196639	197639	198639
Eau distillée			19M6183	1966183	1976183	1986183
Eau distillée chaude			19M640	196640	197640	198640
Eau douce			19M641	196641	197641	198641
Eau épurée			19M642	196642	197642	198642
Eau filtrée			19M643	196643	197643	198643
Eau fluviale			19M644	196644	197644	198644
Eau froide			19M645	196645	197645	198645
Eau froide adoucie			19M6184	1966184	1976184	1986184
Eau froide aller			19M6185	1966185	1976185	1986185
Eau froide non potable			19M6186	1966186	1976186	1986186

# LEIDINGMARKERING

# MARQUAGE DE TUYAUTERIES

Tekst / Texte	GHS / SGH	Signaalwoord Avertissement	150x12mm Vel / File 10st/pc	250x26mm Vel / File 3st/pc	355x37mm Vel / File 3st/pc	450x52mm Vel / File 2st/pc
Eau froide potable			19M6187	1966187	1976187	1986187
Eau froide retour			19M6188	1966188	1976188	1986188
Eau froide sanitaire			19M6189	1966189	1976189	1986189
Eau glacée			19M646	196646	197646	198646
Eau glacée aller			19M6190	1966190	1976190	1986190
Eau glacée retour			19M6191	1966191	1976191	1986191
Eau glycolée			19M6192	1966192	1976192	1986192
Eau glycolée glacée			19M6193	1966193	1976193	1986193
Eau granulation			19M6194	1966194	1976194	1986194
Eau incendie			19M6106	1966106	1976106	1986106
Eau industrielle			19M647	196647	197647	198647
Eau lourde			19M6195	1966195	1976195	1986195
Eau lourde tritié			19M6196	1966196	1976196	1986196
Eau minérale			19M648	196648	197648	198648
Eau mitigée			19M6197	1966197	1976197	1986197
Eau non potable			19M649	196649	197649	198649
Eau osmosée			19M6198	1966198	1976198	1986198
Eau pluviale			19M650	196650	197650	198650
Eau polluée			19M651	196651	197651	198651
Eau potable			19M652	196652	197652	198652
Eau process			19M653	196653	197653	198653
Eau purifiée			19M654	196654	197654	198654
Eau recyclée			19M655	196655	197655	198655
Eau réfrigération			19M6103	1966103	1976103	1986103
Eau réfrigérée			19M6199	1966199	1976199	1986199
Eau refroidie			19M6200	1966200	1976200	1986200
Eau résiduaire			19M656	196656	197656	198656
Eau sanitaire			19M6201	1966201	1976201	1986201
Eau saumurée			19M6202	1966202	1976202	1986202
Eau sous pression			19M6203	1966203	1976203	1986203
Eau surchauffée			19M657	196657	197657	198657
Eau tamisée			19M6204	1966204	1976204	1986204
Eau traitée			19M658	196658	197658	198658
Eau usée			19M659	196659	197659	198659
Eau usine			19M660	196660	197660	198660
Eau viciée			19M661	196661	197661	198661
Fabricatiewater			19M6119	1966119	1976119	1986119
Gechloreerd water			19M662	196662	197662	198662
Gedemineraliseerd water			19M663	196663	197663	198663
Gedistilleerd water			19M664	196664	197664	198664
Geen drinkwater			19M6100	1966100	1976100	1986100
Gefiltreerd water			19M665	196665	197665	198665
Gekoeld water			19M666	196666	197666	198666
Gezuiverd water			19M667	196667	197667	198667
Grondwater			19M668	196668	197668	198668
Heet condensaat			19M6102	1966102	1976102	1986102
Heet water			19M669	196669	197669	198669
Heet water 60°C			19M6127	1966127	1976127	1986127
Heet water 90°C			19M6128	1966128	1976128	1986128
Heet water 110°C			19M6122	1966122	1976122	1986122
Heet water 130°C			19M6123	1966123	1976123	1986123
Heet water 150°C			19M6124	1966124	1976124	1986124

MARQUAGE DE TUYAUTERIES

LEIDINGMARKERING

Tekst / Texte	GHS / SGH	Signaalwoord Avertissement	150x12mm	250x26mm	355x37mm	450x52mm
			Vel /File 10st/pc	Vel /File 3st/pc	Vel /File 3st/pc	Vel /File 2st/pc
Heet water 170°C			19M6125	1966125	1976125	1986125
Heet water 180°C			19M6126	1966126	1976126	1986126
Hogedruk reinigingswater			19M6129	1966129	1976129	1986129
Hogedruk water			19M670	196670	197670	198670
Hydrant water			19M671	196671	197671	198671
Hydrofoor water			19M6130	1966130	1976130	1986130
IJswater			19M672	196672	197672	198672
Industrieel water			19M673	196673	197673	198673
Kanaalwater			19M674	196674	197674	198674
Ketelvoedingswater			19M6131	1966131	1976131	1986131
Ketelwater			19M6132	1966132	1976132	1986132
Koelkringloop			19M6133	1966133	1976133	1986133
Koeltorenwater			19M6134	1966134	1976134	1986134
Koelwater			19M675	196675	197675	198675
Koud condensaat			19M6135	1966135	1976135	1986135
Koud demi-water			19M6136	1966136	1976136	1986136
Koud water			19M676	196676	197676	198676
Kringloopwater			19M677	196677	197677	198677
Lavage			19M678	196678	197678	198678
Onthard water			19M679	196679	197679	198679
Ontkalkt water			19M680	196680	197680	198680
Ontlucht water			19M6137	1966137	1976137	1986137
Orains et exhaures			19M6105	1966105	1976105	1986105
Osrose water			19M6138	1966138	1976138	1986138
Proces koelwater			19M6139	1966139	1976139	1986139
Proces koud water			19M6140	1966140	1976140	1986140
Proces warm water			19M6141	1966141	1976141	1986141
Proceswater			19M681	196681	197681	198681
Purge			19M682	196682	197682	198682
Putwater			19M683	196683	197683	198683
Récyclage eau chaude			19M684	196684	197684	198684
Regenwater			19M685	196685	197685	198685
Réseau sprinkler			19M686	196686	197686	198686
Retour			19M687	196687	197687	198687
Retour CV			19M6142	1966142	1976142	1986142
RIA			19M6207	1966207	1976207	1986207
Rioolwater			19M688	196688	197688	198688
Rivierwater			19M689	196689	197689	198689
Sanitair koud water			19M6143	1966143	1976143	1986143
Sanitair warm water			19M6144	1966144	1976144	1986144
Saumure			19M6208	1966208	1976208	1986208
Spoelwater			19M690	196690	197690	198690
Spuiwater			19M6145	1966145	1976145	1986145
Stadswater			19M691	196691	197691	198691
Toevoer			19M692	196692	197692	198692
Torenwater			19M6146	1966146	1976146	1986146
Vaartwater			19M693	196693	197693	198693
Vervuild water			19M694	196694	197694	198694
Verwarmingswater			19M6147	1966147	1976147	1986147
Vidange			19M695	196695	197695	198695
Voedingswater			19M6148	1966148	1976148	1986148
Warm water			19M696	196696	197696	198696

# LEIDINGMARKERING

# MARQUAGE DE TUYAUTERIES

Tekst / Texte	GHS / SGH	Signaalwoord Avertissement	150x12mm Vel / File 10st/pc	250x26mm Vel / File 3st/pc	355x37mm Vel / File 3st/pc	450x52mm Vel / File 2st/pc
Waswater			19M6149	1966149	1976149	1986149
Water			19M697	196697	197697	198697
Water 10 bar			19M6101	1966101	1976101	1986101
Waterleiding			19M698	196698	197698	198698
Zacht water			19M699	196699	197699	198699
Zeewater			19M6150	1966150	1976150	1986150
<b>Ontvlambare vloeistoffen / Liquides inflammables</b>						
Aardolie			19M701	196701	197701	198701
Acétate de méthyle		DANGER	19M787	196787	197787	198787
Aceton		GEVAAR	19M702	196702	197702	198702
Acétone		DANGER	19M703	196703	197703	198703
Acétonitrile		DANGER	19M788	196788	197788	198788
Acrylonitrile		DANGER	19M789	196789	197789	198789
Additief			19M778	196778	197778	198778
Aftapleiding			19M779	196779	197779	198779
Afvalolie			19M704	196704	197704	198704
Afvoer			19M705	196705	197705	198705
Afvoer solventen			19M775	196775	197775	198775
Alcohol		GEVAAR	19M706	196706	197706	198706
Alcool		DANGER	19M790	196790	197790	198790
Alcool isopropylique		DANGER	19M791	196791	197791	198791
Allylalcohol		GEVAAR	19M780	196780	197780	198780
Azote liquide			19M792	196792	197792	198792
Benzaldehyde		WAARSCHUWING	19M781	196781	197781	198781
Benzeen			19M777	196777	197777	198777
Benzine		GEVAAR	19M707	196707	197707	198707
Brandspiritus			19M782	196782	197782	198782
Butadieen		GEVAAR	19M708	196708	197708	198708
Butanol		GEVAAR	19M709	196709	197709	198709
Cyclohexaan		GEVAAR	19M710	196710	197710	198710
Cyclohexane		DANGER	19M793	196793	197793	198793
Cyclohexanol		WAARSCHUWING	19M711	196711	197711	198711
Cyclohexeen		GEVAAR	19M783	196783	197783	198783
Detergent			19M712	196712	197712	198712
Dieselolie		WAARSCHUWING	19M713	196713	197713	198713
Diethylether		GEVAAR	19M770	196770	197770	198770
Dimethylamine		GEVAAR	19M714	196714	197714	198714
Effluents			19M794	196794	197794	198794
Effluents chimiques			19M795	196795	197795	198795
Egout chimique			19M776	196776	197776	198776
Emulsie			19M784	196784	197784	198784
Emulsions			19M796	196796	197796	198796
Essence		DANGER	19M716	196716	197716	198716
Ethanol		DANGER	19M717	196717	197717	198717
Etheen		GEVAAR	19M718	196718	197718	198718
Ether		GEVAAR	19M719	196719	197719	198719
Ethylacetaat		GEVAAR	19M720	196720	197720	198720
Ethyleen		GEVAAR	19M721	196721	197721	198721
Ethylèneglycol		ATTENTION	19M715	196715	197715	198715
Fioul		ATTENTION	19M797	196797	197797	198797
Fioul domestique		ATTENTION	19M798	196798	197798	198798
Floculant			19M799	196799	197799	198799

Tekst / Texte	GHS / SGH	Signaalwoord Avertissement	150x12mm Vel / File 10st/pc	250x26mm Vel / File 3st/pc	355x37mm Vel / File 3st/pc	450x52mm Vel / File 2st/pc
Fluide frigorigène			19M7100	1967100	1977100	1987100
Formaldehyde		GEVAAR	19M722	196722	197722	198722
Formol		DANGER	19M7101	1967101	1977101	1987101
Fuel		WAARSCHUWING	19M723	196723	197723	198723
Fuel aller		ATTENTION	19M7102	1967102	1977102	1987102
Fuel domestique		ATTENTION	19M724	196724	197724	198724
Fuel léger		ATTENTION	19M7103	1967103	1977103	1987103
Fuel lourd		ATTENTION	19M7104	1967104	1977104	1987104
Fuel retour		ATTENTION	19M7105	1967105	1977105	1987105
Gasoil		ATTENTION	19M725	196725	197725	198725
Gasolie		WAARSCHUWING	19M726	196726	197726	198726
Gazole		ATTENTION	19M7106	1967106	1977106	1987106
Glycerine			19M727	196727	197727	198727
Glycol		WAARSCHUWING	19M728	196728	197728	198728
Graisse			19M729	196729	197729	198729
Heptaan		GEVAAR	19M730	196730	197730	198730
Hexaan		GEVAAR	19M731	196731	197731	198731
Huile de coupe			19M7107	1967107	1977107	1987107
Huile de lubrification			19M7108	1967108	1977108	1987108
Huile hydraulique			19M732	196732	197732	198732
Huile hydraulique polluée			19M733	196733	197733	198733
Huile hydraulique propre			19M734	196734	197734	198734
Huile neuve			19M7109	1967109	1977109	1987109
Huile récupérée			19M7110	1967110	1977110	1987110
Huile soluble			19M735	196735	197735	198735
Huile thermique			19M736	196736	197736	198736
Huisbrandolie		WAARSCHUWING	19M737	196737	197737	198737
Hydraulische olie			19M738	196738	197738	198738
IPA		GEVAAR	19M7124	1967124	1977124	1987124
IPA		DANGER	19M772	196772	197772	198772
Isopropanol		GEVAAR	19M7122	1967122	1977122	1987122
Isopropanol		DANGER	19M771	196771	197771	198771
Kérosène		DANGER	19M739	196739	197739	198739
Lichte stookolie		WAARSCHUWING	19M740	196740	197740	198740
Liquide alimentaire			19M7111	1967111	1977111	1987111
Loodvrije benzine		GEVAAR	19M741	196741	197741	198741
Mazout		GEVAAR	19M7121	1967121	1977121	1987121
MeOH		DANGER	19M769	196769	197769	198769
Methanol		GEVAAR	19M742	196742	197742	198742
Méthanol		DANGER	19M743	196743	197743	198743
Methylethylketon		GEVAAR	19M744	196744	197744	198744
Minerale olie			19M745	196745	197745	198745
Motorbenzine		GEVAAR	19M746	196746	197746	198746
Motorolie			19M747	196747	197747	198747
Olie			19M748	196748	197748	198748
Oxygène liquide		DANGER	19M7112	1967112	1977112	1987112
Parafine olie		GEVAAR	19M749	196749	197749	198749
Petroleum		GEVAAR	19M750	196750	197750	198750
Product			19M766	196766	197766	198766
Propanol		DANGER	19M7113	1967113	1977113	1987113
Résidu			19M751	196751	197751	198751
Retour radioactif			19M7114	1967114	1977114	1987114
Smeerolie			19M752	196752	197752	198752

# LEIDINGMARKERING

# MARQUAGE DE TUYAUTERIES

Tekst / Texte	GHS / SGH	Signaalwoord Avertissement	150x12mm Vel / File 10st/pc	250x26mm Vel / File 3st/pc	355x37mm Vel / File 3st/pc	450x52mm Vel / File 2st/pc
Solstar			19M774	196774	197774	198774
Solvents usés			19M7115	1967115	1977115	1987115
Stookolie		WAARSCHUWING	19M753	196753	197753	198753
Styreen		WAARSCHUWING	19M754	196754	197754	198754
Super		GEVAAR	19M755	196755	197755	198755
Terpentijn		GEVAAR	19M756	196756	197756	198756
Tetrahydrofurane		DANGER	19M7116	1967116	1977116	1987116
Thermische olie			19M757	196757	197757	198757
Tolueen		GEVAAR	19M758	196758	197758	198758
Toluène		DANGER	19M759	196759	197759	198759
Trichloréthylène		DANGER	19M7118	1967118	1977118	1987118
Verdunner			19M760	196760	197760	198760
Vet			19M761	196761	197761	198761
Vinylacetaat		GEVAAR	19M785	196785	197785	198785
Waste			19M767	196767	197767	198767
Waste chloré			19M768	196768	197768	198768
Waterstofperoxide		GEVAAR	19M786	196786	197786	198786
Waterstofperoxide 35%		GEVAAR	19M762	196762	197762	198762
White spirit		GEVAAR	19M773	196773	197773	198773
Xyleen		WAARSCHUWING	19M763	196763	197763	198763
Xylène		ATTENTION	19M7119	1967119	1977119	1987119
Zuurstof		GEVAAR	19M764	196764	197764	198764
Zwavel		WAARSCHUWING	19M765	196765	197765	198765

Stoom / Vapeur

Air comprimé régulation			19M817	196817	197817	198817
Air comprimé service			19M818	196818	197818	198818
Basse pression			19M801	196801	197801	198801
Haute pression			19M802	196802	197802	198802
HD Stoom			19M803	196803	197803	198803
Hoge druk			19M804	196804	197804	198804
Hoge druk stoom			19M805	196805	197805	198805
Industriële stoom			19M806	196806	197806	198806
Lage druk			19M807	196807	197807	198807
Lage druk stoom			19M808	196808	197808	198808
LD stoom			19M821	196821	197821	198821
Oververhitte stoom			19M822	196822	197822	198822
Processtoom			19M823	196823	197823	198823
Purge de vapeur			19M833	196833	197833	198833
Stoom			19M809	196809	197809	198809
Stoom 0,5 bar			19M824	196824	197824	198824
Stoom 1,5 bar			19M825	196825	197825	198825
Stoom 2,8 bar			19M827	196827	197827	198827
Stoom 3 bar			19M816	196816	197816	198816
Stoom 4 bar			19M828	196828	197828	198828
Stoom 5,5 bar			19M829	196829	197829	198829
Stoom 8 bar			19M831	196831	197831	198831
Stoom 12 bar			19M826	196826	197826	198826
Stoom 50 bar			19M830	196830	197830	198830
Vapeur			19M810	196810	197810	198810
Vapeur 4 bars			19M836	196836	197836	198836
Vapeur 6 bars			19M837	196837	197837	198837
Vapeur 10 bars			19M834	196834	197834	198834

Tekst / Texte	GHS / SGH	Signaalwoord Avertissement	150x12mm	250x26mm	355x37mm	450x52mm
			Vel / Ffle 10st/pc	Vel / Ffle 3st/pc	Vel / Ffle 3st/pc	Vel / Ffle 2st/pc
Vapeur 24 bars			19M835	196835	197835	198835
Vapeur basse pression			19M811	196811	197811	198811
Vapeur BP			19M838	196838	197838	198838
Vapeur condensat			19M820	196820	197820	198820
Vapeur d'humidification			19M812	196812	197812	198812
Vapeur haute pression			19M813	196813	197813	198813
Vapeur HP			19M839	196839	197839	198839
Vapeur MP			19M840	196840	197840	198840
Vapeur pure			19M819	196819	197819	198819
Vapeur saturée			19M842	196842	197842	198842
Vapeur saturée d'humidité			19M841	196841	197841	198841
Vapeur surchauffée			19M843	196843	197843	198843
Verzadigde stoom			19M832	196832	197832	198832
Waterdamp			19M814	196814	197814	198814
Zuivere stoom			19M815	196815	197815	198815
<b>Zuren &amp; Basen / Acides &amp; Bases</b>						
Acetylchloride		GEVAAR	19M958	196958	197958	198958
Acide			19M902	196902	197902	198902
Acide acétique		DANGER	19M972	196972	197972	198972
Acide chlorhydrique		DANGER	19M901	196901	197901	198901
Acide fluorhydrique		DANGER	19M973	196973	197973	198973
Acide formique		DANGER	19M974	196974	197974	198974
Acide gras			19M977	196977	197977	198977
Acide nitrique		DANGER	19M975	196975	197975	198975
Acide oxalique		ATTENTION	19M976	196976	197976	198976
Acide phosphorique		DANGER	19M903	196903	197903	198903
Acide sulfurique		DANGER	19M904	196904	197904	198904
Acrylzuur		GEVAAR	19M905	196905	197905	198905
Afvalzuur			19M959	196959	197959	198959
Afvoer (zuur)			19M960	196960	197960	198960
Alkalische oplossing			19M906	196906	197906	198906
Allylamine		DANGER	19M907	196907	197907	198907
Ammoniak		GEVAAR	19M908	196908	197908	198908
Ammoniaque		DANGER	19M909	196909	197909	198909
Azijnzuur		GEVAAR	19M910	196910	197910	198910
Azijnzuuranhydride		GEVAAR	19M961	196961	197961	198961
Base			19M979	196979	197979	198979
Bleekwater		GEVAAR	19M911	196911	197911	198911
Carbonate de sodium		DANGER	19M912	196912	197912	198912
Chloorbleekwater		GEVAAR	19M913	196913	197913	198913
Chloorwaterstof		GEVAAR	19M914	196914	197914	198914
Chlorure d'hydrogène		DANGER	19M915	196915	197915	198915
Chlorure ferrique			19M980	196980	197980	198980
CIP			19M946	196946	197946	198946
Eau de javel		DANGER	19M916	196916	197916	198916
Fluorure d'hydrogène		DANGER	19M982	196982	197982	198982
Fluorure de sodium		DANGER	19M983	196983	197983	198983
Fluorwaterstof		GEVAAR	19M917	196917	197917	198917
Formol		DANGER	19M918	196918	197918	198918
Fosforzuur		GEVAAR	19M919	196919	197919	198919
Geconcentreerd zwavelzuur		GEVAAR	19M920	196920	197920	198920
Geregenereerd zuur			19M962	196962	197962	198962

# LEIDINGMARKERING

# MARQUAGE DE TUYAUTERIES

Tekst / Texte	GHS / SGH	Signaalwoord Avertissement	150x12mm Vel / File 10st/pc	250x26mm Vel / File 3st/pc	355x37mm Vel / File 3st/pc	450x52mm Vel / File 2st/pc
Glycol		WAARSCHUWING	19M921	196921	197921	198921
Glycol		ATTENTION	19M990	196990	197990	198990
H2SO4			19M954	196954	197954	198954
HCl		GEVAAR	19M922	196922	197922	198922
HF			19M952	196952	197952	198952
Hydrazine		GEVAAR	19M923	196923	197923	198923
Hydroxide de potassium		DANGER	19M984	196984	197984	198984
Hypochlorite de sodium		DANGER	19M985	196985	197985	198985
IJzerchloride			19M924	196924	197924	198924
Javel		DANGER	19M925	196925	197925	198925
Kaliloog		GEVAAR	19M926	196926	197926	198926
Kaliumhydroxide		GEVAAR	19M927	196927	197927	198927
Lait de chaux			19M986	196986	197986	198986
Lessive de soude		DANGER	19M987	196987	197987	198987
Loog			19M928	196928	197928	198928
Melkzuur		GEVAAR	19M948	196948	197948	198948
Methylamine		GEVAAR	19M929	196929	197929	198929
Mierenzuur		GEVAAR	19M930	196930	197930	198930
NaHSO3		GEVAAR	19M955	196955	197955	198955
NaOH		GEVAAR	19M957	196957	197957	198957
Natriumhydroxide		GEVAAR	19M931	196931	197931	198931
Natriumloog		GEVAAR	19M932	196932	197932	198932
Nitrate			19M933	196933	197933	198933
Nitrite de sodium		DANGER	19M934	196934	197934	198934
Oleum		GEVAAR	19M963	196963	197963	198963
Oléum		DANGER	19M988	196988	197988	198988
Phénol		DANGER	19M935	196935	197935	198935
Potassium		DANGER	19M936	196936	197936	198936
Propionzuur		GEVAAR	19M949	196949	197949	198949
Salpeterzuur		GEVAAR	19M937	196937	197937	198937
Selenigzuur		GEVAAR	19M964	196964	197964	198964
Soda		GEVAAR	19M938	196938	197938	198938
Sodium sulphide		DANGER	19M989	196989	197989	198989
Soude		DANGER	19M939	196939	197939	198939
Soude caustique		DANGER	19M940	196940	197940	198940
TEA			19M953	196953	197953	198953
TEA / DCM			19M951	196951	197951	198951
TFA Trifluo			19M950	196950	197950	198950
Verdund zwavelzuur		GEVAAR	19M965	196965	197965	198965
Vers zuur			19M966	196966	197966	198966
Waterstofchloride		GEVAAR	19M941	196941	197941	198941
Waterstoffluoride		GEVAAR	19M942	196942	197942	198942
Zoutzuur		GEVAAR	19M943	196943	197943	198943
Zoutzuur 36%		GEVAAR	19M967	196967	197967	198967
Zure oplossing			19M968	196968	197968	198968
Zuur			19M944	196944	197944	198944
Zuurmengsel			19M947	196947	197947	198947
Zwavelzuur		GEVAAR	19M945	196945	197945	198945
Zwavelzuur 10%		GEVAAR	19M969	196969	197969	198969
Zwavelzuur 78%		GEVAAR	19M970	196970	197970	198970
Zwavelzuur 96%		GEVAAR	19M971	196971	197971	198971

MARQUAGE DE TUYAUTERIES

LEIDINGMARKERING

Tekst / Texte	GHS / SGH	Signaalwoord Avertissement	150x12mm Vel / Ffle 10st/pc	250x26mm Vel / Ffle 3st/pc	355x37mm Vel / Ffle 3st/pc	450x52mm Vel / Ffle 2st/pc
<b>Zuren / Acides</b>						
Acetylchloride		GEVAAR	19M1001	1961001	1971001	1981001
Acrylzuur		GEVAAR	19M1002	1961002	1971002	1981002
Afvalzuur			19M1003	1961003	1971003	1981003
Afvoer (zuur)			19M1004	1961004	1971004	1981004
Azijnzuur		GEVAAR	19M1005	1961005	1971005	1981005
Azijnzuuranhydride		GEVAAR	19M1006	1961006	1971006	1981006
Chloorwaterstof		GEVAAR	19M1007	1961007	1971007	1981007
Fluorwaterstof		GEVAAR	19M1008	1961008	1971008	1981008
Fosforzuur		GEVAAR	19M1009	1961009	1971009	1981009
Geconcentreerd zwavelzuur		GEVAAR	19M1010	1961010	1971010	1981010
Geregenereerd zuur			19M1011	1961011	1971011	1981011
HCl		GEVAAR	19M1012	1961012	1971012	1981012
Ijzerchloride			19M1013	1961013	1971013	1981013
Mierenzuur		GEVAAR	19M1014	1961014	1971014	1981014
Oleum		GEVAAR	19M1015	1961015	1971015	1981015
Salpeterzuur		GEVAAR	19M1016	1961016	1971016	1981016
Selenigzuur		GEVAAR	19M1017	1961017	1971017	1981017
Verdund zwavelzuur		GEVAAR	19M1018	1961018	1971018	1981018
Vers zuur			19M1019	1961019	1971019	1981019
Waterstofchloride		GEVAAR	19M1020	1961020	1971020	1981020
Waterstoffluoride		GEVAAR	19M1021	1961021	1971021	1981021
Zoutzuur		GEVAAR	19M1022	1961022	1971022	1981022
Zoutzuur 36%		GEVAAR	19M1023	1961023	1971023	1981023
Zure oplossing			19M1024	1961024	1971024	1981024
Zuur			19M1025	1961025	1971025	1981025
Zwavelzuur		GEVAAR	19M1026	1961026	1971026	1981026
Zwavelzuur 10%		GEVAAR	19M1027	1961027	1971027	1981027
Zwavelzuur 78%		GEVAAR	19M1028	1961028	1971028	1981028
Zwavelzuur 96%		GEVAAR	19M1029	1961029	1971029	1981029

## Houders voor leidingmerkers

## Support marquage tuyauterie



PP	
200x25	47LM00
280x45	47L600
375x50	47L700
460x65	47L800



Kabelbandjes Colliers de serrage	
200x3,6mm	
TRSP	8124.01
	8124.02
	8124.03
	8124.04
	8124.05
	8124.06
	8124.07
	8124.08
	8124.09
	8124.10



# LEIDINGMARKERINGEN OP ROL

# MARQUAGES DE TUYAUTERIES EN ROULEAU

Materiaal/Matériel: Vinyl(e) Eco-digital of/ou Multigrip - met laminaat/avec laminat

MARQUAGES DE TUYAUTERIES EN ROULEAU

Rollengte / Longueur rouleau	Ø Leiding/Tuyau < 30mm		< 50mm		> 70mm		> 300mm	
	70mm	90mm	90mm	110mm	90mm	137mm	160mm	240mm
5m	Multigrip + lamina(a)t 19AC..	Multigrip + lamina(a)t 19XC..	Multigrip + lamina(a)t 19NC..	Multigrip + lamina(a)t 19UC..	Multigrip + lamina(a)t 19VC..	Multigrip + lamina(a)t 19FC..	Multigrip + lamina(a)t 19WC..	Multigrip + lamina(a)t 19ZC..
15m	Eco-digital + lamina(a)t 19AB..	Eco-digital + lamina(a)t 19XB..	Eco-digital + lamina(a)t 19NB..	Eco-digital + lamina(a)t 19UB..	Eco-digital + lamina(a)t 19VB..	Eco-digital + lamina(a)t 19FB..	Eco-digital + lamina(a)t 19WB..	Eco-digital + lamina(a)t 19ZB..
	Multigrip + lamina(a)t 19AD..	Multigrip + lamina(a)t 19XD..	Multigrip + lamina(a)t 19ND..	Multigrip + lamina(a)t 19UD..	Multigrip + lamina(a)t 19VD..	Multigrip + lamina(a)t 19FD..	Multigrip + lamina(a)t 19WD..	Multigrip + lamina(a)t 19ZD..
20m	Eco-digital + lamina(a)t 19AA..	Eco-digital + lamina(a)t 19XA..	Eco-digital + lamina(a)t 19BA..	Eco-digital + lamina(a)t 19UA..	Eco-digital + lamina(a)t 19EA..	Eco-digital + lamina(a)t 19FA..	Eco-digital + lamina(a)t 19WA..	Eco-digital + lamina(a)t 19ZA..
	Multigrip + lamina(a)t 19AE..	Multigrip + lamina(a)t 19XE..	Multigrip + lamina(a)t 19NE..	Multigrip + lamina(a)t 19UE..	Multigrip + lamina(a)t 19VE..	Multigrip + lamina(a)t 19FE..	Multigrip + lamina(a)t 19WE..	Multigrip + lamina(a)t 19ZE..

### Hoe te bestellen?

- Bepaal het gewenste formaat en uitvoering
- Selecteer het materiaal en de lengte
- Kies de juiste kleurcode
- Bepaal de tekstcode (pag. 320-333)
- Een special? Gebruik MT als tekstcode

### Kleurcode/Code couleur

19..2..	2
19..3..	3
19..4..	4
19..5..	5
19..6..	6
19..7..	7
19..8..	8
19..9..	9
19..10..	10

### Comment commander?

- Déterminez le lay-out et les dimensions souhaitées
- Selectionnez le matériel et la longueur
- Choisissez le code couleur correct
- Déterminez le code texte (pag. 320-333)
- Quelque chose de spécial? Utilisez MT comme code texte

### Voorbeelden / Exemples



Ø < 50mm  
90mm x 5m  
Multigrip + lamina(a)t  
**19NC675**



Ø > 70mm  
137mm x 20m  
Ecodigital + lamina(a)t  
**19FA919**



Ø < 30mm  
90mm x 15m  
Multigrip + lamina(a)t  
**19XD7121**

ISO 20560-conforme leidingmerkers beschikbaar op aanvraag  
Marqueurs de tuyauteries conformes à la norme ISO 20560 disponible sur demande

## Houders van leidingmerkers

## Support marquage tuyauterie

Speciaal voor agressieve omgevingen.

Te gebruiken wanneer de plaatsing van markeringen met kleeflaag moeilijk is : vette, geroeste, gekatelde of geïsoleerde leidingen.

Spécialement pour les environnements agressifs.

A utiliser lorsque le placement des marquages adhésifs est difficile : tuyaux gras, rouillés, moletés ou isolés.

PP		
200x25mm	voor merker 150x12 mm	47LM00
280x45mm	voor merker 250x26	47L600
375x50mm	voor merker 355x37	47L700
460x55mm	voor merker 450x52	47L800



## Bordhouders

## Supports panneaux

Geprofileerde bordhouders voor de markering van buisleidingen, ventielen, afsluiters, hydranten, ...  
 . Bevestiging met schroeven, rivetten, popnagels, spanningen, ...  
 De bordhouders en plaatjes zijn leverbaar in diverse materialen. Ze worden op vraag gefabriceerd volgens de teksten en wensen van de klant. Prijzen steeds op aanvraag.

Supports panneaux profilés pour le marquage de vos tuyaux, valves, hydrants, ...  
 . Fixation avec des vis, rivets, colliers de serrage, ...  
 Les supports et plaques sont livrables en différents matériaux. Les plaques sont fabriquées sur demande avec les textes et souhaits du client. Prix toujours sur demande.



	PBTP	Alu	Inox
60x38mm	4721		
80x38mm	4722	4712	4742
100x50mm	4723	4713	4743
120x50mm	4724	4714	4744
140x50mm	4725	4715	4745
140x90mm	4726	4716	4746
160x90mm	4727		
200x90mm	4728		



Vlakke bordhouders  
Supports panneaux plats

	Alu 2mm	Inox 1mm
55x20mm	4730	4760
108x20mm	4731	4761
100x50mm	4732	4762
116x50mm	4733	4763
150x75mm	4734	
200x100mm	4735	
200x200mm	4736	
250x200mm	4737	
300x200mm	4738	
400x200mm	4739	



Bordhouders met 3-zijdige boord  
Supports panneaux à 3-bords

	Alu	Inox
80x38mm	47A1	47C1
100x38mm	47A2	47C2
100x50mm	47A3	47C3
120x50mm	47A4	47C4





**Spanringen in INOX**  
Colliers en INOX

Diam.buis Diam.tuyau		Diam.buis Diam.tuyau	
12-22mm	4750	80-100mm	4755
20-32mm	4751	100-120mm	4756
25-40mm	4752	120-140mm	4757
40-60mm	4753	140-160mm	4758
60-80mm	4754	150-170mm	4759



**Snelmontageband in comb. met 4795 en 4796**  
Ruban de montage en comb. avec 4795 et 4796

	Zwart Noir
12,7mmx25mtr	4794
Klem 10stks	4795
Attaches 10pcs	



**Montagetang in comb. met 4794 en 4795**  
Pince de montage en comb. avec 4794 et 4795

4796



**Popnagels**  
Rivets

4797

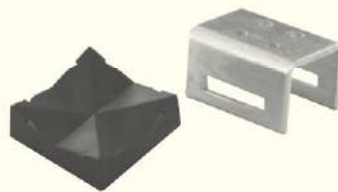

**Adapter leidingen  $\phi < 25\text{mm}$**   
Adaptateur tuyauterie  $\phi < 25\text{mm}$

PBTP	4791
ALU	4792
INOX	4793



**Afstandhouders**  
Entretoises plates

	Boring Forage	Alu 13mm	Alu 17mm	Inox 13mm	Inox 17mm
105x18x1,5mm				4784	
105x18x2mm		4780			
105x22x1,5mm				4786	
105x22x2mm		4782			
200x18x1,5mm				4785	
200x22x1,5mm				4787	
200x22x2mm		4781	4783		

Hoogwaardige gedrukte plaatjes gefabriceerd op formaat van de houders.  
Beschikbaar in diverse materialen en UV- en oplosmiddelbestendig.

Panneaux imprimés de qualité supérieure et aux dimensions des supports.  
Disponible en différents matériaux et Anti-UV et solvants.



RESOPAL : -40°C - +140°C  
MELAMINE : -40°C - +170°C  
ALUMINIUM : -50°C - +200°C  
RVS/INOX : -50°C - +300°C

Prijzen steeds op aanvraag.  
Prix toujours sur demande.

Sleuteltype	Type d'application / Type toepassing			Matériau d'anse / Materiaal beugel				Spécificités techniques / Technische eigenschappen											
	Consignation électrique / Elektrische vergrendeling	Consignation mécanique / Mechanische vergrendeling	Usage Extérieur / Buitengebruik	Composite / Composit	Inox / Roestvrij staal	Acier / Geplateerd staal	Acier cémenté / Gehard staal	En ligne avec le standard OSHA / Conform OSHA-eisen	Nombre de clés fournies / Aantal sleutels bijgeleverd	Revue de clé / Sleutelborging	Profil de clé dédié / Gereserveerd sleutelgat	Système de clés sur mesure / Gepersonaliseerd hoofdsleutelsysteem	Gepersonaliseerd hoofdsleutelsysteem	Tracabilité des clés / Sleutelmap	Cadenas non magnétique / Niet-magnetisch hangslot	Cadenas anti-éfnicelle / Anti-vonken hangslot	Étiquettes d'identification / ID-labels	Couleurs disponibles / Beschikbare kleuren	Poids / Gewicht
S31	-	✓	✓	-	-	-	✓	✓	1	✓	✓	✓	-	✓	-	-	*	9	80g
S32	✓	✓	-	✓	-	-	-	✓	1	✓	✓	✓	-	✓	✓	✓	9	40g	
410	-	✓	✓	-	-	✓	-	✓	1	✓	✓	✓	-	✓	-	✓	8	100g	
406	✓	✓	-	✓	-	-	-	✓	1	-	✓	✓	-	✓	✓	✓	8	60g	
S1100	-	✓	✓	-	✓	-	-	✓	1	✓	✓	✓	-	✓	-	✓	9	120g	

#### Met verschillende sleutels (KD)

Elk hangslot heeft zijn eigen sleutel.  
Sleutel n°1 opent hangslot n°1 en alleen hangslot n°1.  
Sleutel n°2 opent hangslot n°2 en alleen hangslot n°2.  
Sleutel n°3 opent hangslot n°3 en alleen hangslot n°3...



#### Cadenas à clé différente (KD)

Chaque cadenas a sa propre clé pour l'ouvrir.  
La clé n°1 ouvre le cadenas n°1 et seulement le cadenas n°1.  
La clé n°2 ouvre le cadenas n°2 et seulement le cadenas n°2.  
La clé n°3 ouvre le cadenas n°3 et seulement le cadenas n°3...

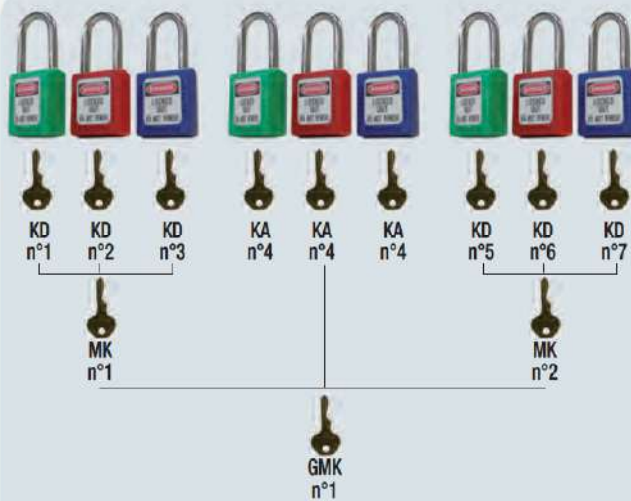

#### Met gelijke sleutels (KA)

Alle sleutels zijn gelijk.  
Alle sleutels openen alle hangsloten.  
Sleutel n°1 opent zonder onderscheid hangsloten n°1, n°2, n°3....  
Dit is niet hetzelfde als een hoofdsleutel.



#### Cadenas s'ouvrant (KA)

Toutes les clés sont les mêmes.  
Toutes les clés ouvrent tous les cadenas.  
La clé n°1 ouvre indifféremment le cadenas n°1, n°2, n°3....  
Cette clé n'est pas un passe-partout.

#### Met hoofdsleutel (MK)

Een hoofdsleutel opent een systeem van hangsloten met verschillende sleutels.



#### Passe-partout (MK)

Un passe-partout ouvre un ensemble de cadenas à clé différente.

#### Met centrale hoofdsleutel (GMK)

Eén sleutel opent alle hangsloten in verschillende groepen KD, KA of MK

#### Grand passe-partout (GMK)

Une clé ouvre tous les cadenas de plusieurs groupes à clés différentes, à clés identiques ou à clé passe-partout

Zenex sloten met stalen beugel

Cadenas Zenex avec anse en acier

### S31



- Zenex huis / RVS-beugel
- Corrosiebestendig
- Beugeldiameter 4,76mm
- Geleverd met 1 vastzittende sleutel
- Lasergravering en identificatielabels mogelijk

- Corps en Zenex / Anse en inox
- Résistance à la corrosion
- Anse de 4,76mm diamètre
- Une seule clé - retenue de clé
- Gravure au laser et labels d'identification possible

Omschrijving Description	Beugel / Anse 38mm	Beugel / Anse 76mm
Verschillende sleutels Clés différents	S31	S31LT
Gelijke sleutels S'ouvrant	S31KA	S31KALT
Hoofdsleutel Passe-partout	S31MK	S31MKLT
Gelijke sleutels en hoofdsleutel S'ouvrant et passe-partout	S31KAMK	S31KAMKLT

Met loszittende sleutel: S33  
Sans retenue de clé: S33



9 beschikbare kleuren - De gewenste kleurcode toevoegen aan het artikelnummer  
9 couleurs disponibles - Ajouter le suffixe de la couleur souhaitée au code d'article



Robuuste weerbestendige kap voor de S31 die de beugelbasis en het sleutelgat beschermt.

Couvercle robuste pour le S31 qui protège la base de l'anse et l'entrée de la clé.

S30C0V

### 410



- Zenex huis / Beugel geplaatst staal
- Corrosiebestendig
- Beugeldiameter 6mm
- Geleverd met 1 vastzittende sleutel
- Lasergravering en identificatielabels mogelijk

- Corps en Zenex / Anse en acier
- Résistance à la corrosion
- Anse de 6mm diamètre
- Une seule clé - retenue de clé
- Gravure au laser et labels d'identification possible

Omschrijving Description	Beugel / Anse 38mm	Beugel / Anse 76mm
Verschillende sleutels Clés différents	410	410LT
Gelijke sleutels S'ouvrant	410KA	410KALT
Hoofdsleutel Passe-partout	410MK	410MKLT
Gelijke sleutels en hoofdsleutel S'ouvrant et passe-partout	410KAMK	410KAMKLT

Geef bij bestelling van KA of MK sloten steeds door of het een nieuwe reeks of een aanvulling betreft.

Spécifiez dans votre commande des cadenas KA ou MK s'il concerne d'un nouvel ensemble ou un supplément.



8 beschikbare kleuren - De gewenste kleurcode toevoegen aan het artikelnummer  
8 couleurs disponibles - Ajouter le suffixe de la couleur souhaitée au code d'article



Robuuste weerbestendige kap voor de 410 die de beugelbasis en het sleutelgat beschermt.

Couvercle robuste pour le 410 qui protège la base de l'anse et l'entrée de la clé.

400C0V

Zenex sloten met stalen beugel

Cadenas Zenex avec anse en acier

### 411

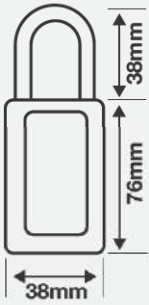

- Zenex huis / Beugel geplateerd staal
- Corrosiebestendig
- Beugeldiameter 6mm
- Geleverd met 1 vastzittende sleutel
- Lasergravering en identificatielabels mogelijk

- Corps en Zenex / Anse en acier
- Résistance à la corrosion
- Anse de 6mm diamètre
- Une seule clé - retenue de clé
- Gravure au laser et labels d'identification possible

Omschrijving Description	Beugel / Anse 38mm	Beugel / Anse 76mm
Verschillende sleutels Clés différents	411	411LT
Gelijke sleutels S'entrouvrant	411KA	411KALT
Hoofdsleutel Passe-partout	411MK	411MKLT
Gelijke sleutels en hoofdsleutel S'entrouvrant et passe-partout	411KAMK	411KAMKLT



8 beschikbare kleuren - De gewenste kleurcode toevoegen aan het artikelnummer  
8 couleurs disponibles - Ajouter le suffixe de la couleur souhaitée au code d'article



Robuuste weerbestendige kap voor de 411 die de beugelbasis en het sleutelgat beschermt.

Couvercle robuste pour le 411 qui protège la base de l'anse et l'entrée de la clé.

411C0V

Zenex sloten met Zenex beugel

Cadenas Zenex avec anse en Zenex

### S32



Zone 2

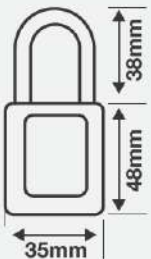

- Zenex huis / Zenex beugel
- Corrosiebestendig
- Beugeldiameter 4,76mm
- Geleverd met 1 niet-vastzittende sleutel
- Lasergravering en identificatielabels mogelijk
- Geschikt voor explosieve atmosfeer Zone 2



Zone 2

- Corps en Zenex / Anse en Zenex
- Résistance à la corrosion
- Anse de 4,76mm diamètre
- Fourni avec une seule clé - sans retenue de clé
- Gravure au laser et labels d'identification possible
- Convient pour une utilisation dans les atmosphères explosives Zone 2

Omschrijving Description	Beugel / Anse 38mm
Verschillende sleutels Clés différents	S32
Gelijke sleutels S'entrouvrant	S32KA
Hoofdsleutel Passe-partout	S32MK
Gelijke sleutels en hoofdsleutel S'entrouvrant et passe-partout	S32KAMK



9 beschikbare kleuren - De gewenste kleurcode toevoegen aan het artikelnummer  
9 couleurs disponibles - Ajouter le suffixe de la couleur souhaitée au code d'article



Robuuste weerbestendige kap voor de S32 die de beugelbasis en het sleutelgat beschermt.

Couvercle robuste pour le S32 qui protège la base de l'anse et l'entrée de la clé.

S30C0V

Zenex sloten met Zenex beugel

Cadenas Zenex avec anse en Zenex

## 406



Zone 2

- Zenex huis / Zenex beugel
- Corrosiebestendig
- Beugeldiameter 6mm
- Geleverd met 1 vastzittende sleutel
- Lasergravering en identificatielabels mogelijk
- Geschikt voor explosieve atmosfeer Zone 2



Omschrijving Description	Beugel / Anse 38mm
Verschillende sleutels Clés différents	406
Gelijke sleutels S'entrouvrant	406KA
Hoofdsleutel Passe-partout	406MK
Gelijke sleutels en hoofdsleutel S'entrouvrant et passe-partout	406KAMK



Zone 2

- Corps en Zenex / Anse en Zenex
- Résistance à la corrosion
- Anse de 6mm diamètre
- Une seule clé - retenue de clé
- Gravure au laser et labels d'identification possible
- Convient pour une utilisation dans les atmosphères explosives Zone 2



Vermeld bij uw bestelling steeds de gewenste kleur voor de sloten.

Mentionnez toujours le couleur des cadenas lors de votre commande.



8 beschikbare kleuren - De gewenste kleurcode toevoegen aan het artikelnummer  
8 couleurs disponibles - Ajouter le suffixe de la couleur souhaitée au code d'article



Robuuste weerbestendige kap voor de 406 die de beugelbasis en het sleutelgat beschermt.

Couvercle robuste pour le 406 qui protège la base de l'anse et l'entrée de la clé.

400C0V

## Gravures

## Gravages

Een permanente en duurzame methode om uw vergrendelingshangsloten te personaliseren.

Une identification permanente et résistante de vos cadenas de consignment.

Lasergravering op hangslot S31, S32, 410, 406  
Gravage laser sur cadenas S31, S32, 410, 406

Lasergravering op hangslot 411  
Gravage laser sur cadenas 411

Lasergravering op hangslot 6835, S6835, S1100  
Gravage laser sur cadenas 6835, S6835, S1100

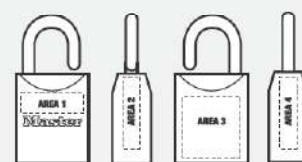
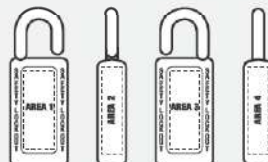

Personalisatie - Personalisation

LZ1	Gravure op 1 zone - Gravage sur 1 zone
LZ2	Gravure op 2 zones - Gravage sur 2 zones
LZ3	Gravure op 3 zones - Gravage sur 3 zones
LZ4	Gravure op 4 zones - Gravage sur 4 zones



Aluminium sloten

Cadenas en aluminium

### 6835

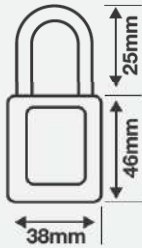

- Aluminium huis / Beugel versterkt staal
- Zeer corrosiebestendig
- Beugeldiameter 6 mm
- Geleverd met 2 niet-vastzittende sleutels
- Lasergravering en identificatielabels mogelijk

- Corps en aluminium / Anse en acier cémenté
- Haute résistance à la corrosion
- Anse de 6 mm diamètre
- Avec 2 clés - sans retenue de clé
- Gravure au laser et labels d'identification possible



Omschrijving Description	Beugel / Anse 25mm	Beugel / Anse 38mm	Beugel / Anse 75mm
Verschillende sleutels Clés différents	6835	6835LF	6835LT
Gelijke sleutels S'entrouvrant	6835KA	6835KALF	6835KALT
Hoofdsleutel Passe-partout	6835MK	6835MKLF	6835MKLT
Gelijke sleutels en hoofdsleutel S'entrouvrant et passe-partout	6835KAMK	6835KAMKLF	6835KAMKLT



Verschillende tags en  
gepersonaliseerde labels mogelijk.  
Bekijk het assortiment vanaf pagina 360

Différents tags et labels possible.  
Considérez l'assortiment depuis page 360



6 beschikbare kleuren - De gewenste kleurcode toevoegen aan het artikelnummer  
6 couleurs disponibles - Ajouter le suffixe de la couleur souhaitée au code d'article



Robuuste weerbestendige kap  
voor de 6835 die de beugelbasis  
en het sleutelgat beschermt.

Couvercle robuste pour le 6835  
qui protège la base de l'anse  
et l'entrée de la clé.

S101C0V

### S6835

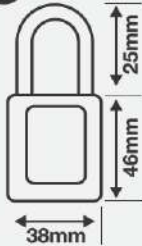

- Aluminium huis / Beugel versterkt staal
- Corrosiebestendig
- Beugeldiameter 6 mm
- Geleverd met 1 vastzittende sleutel
- Lasergravering en identificatielabels mogelijk

- Corps en aluminium / Anse en acier cémenté
- Résistance à la corrosion
- Anse de 6 mm diamètre
- Une seule clé - retenue de clé
- Gravure au laser et labels d'identification possible



Omschrijving Description	Beugel / Anse 25mm	Beugel / Anse 38mm	Beugel / Anse 75mm
Verschillende sleutels Clés différents	S6835	S6835LF	S6835LT
Gelijke sleutels S'entrouvrant	S6835KA	S6835KALF	S6835KALT
Hoofdsleutel Passe-partout	S6835MK	S6835MKLF	S6835MKLT
Gelijke sleutels en hoofdsleutel S'entrouvrant et passe-partout	S6835KAMK	S6835KAMKLF	S6835KAMKLT



6 beschikbare kleuren - De gewenste kleurcode toevoegen aan het artikelnummer  
6 couleurs disponibles - Ajouter le suffixe de la couleur souhaitée au code d'article



Robuuste weerbestendige kap  
voor de S6835 die de beugel-  
basis en het sleutelgat  
beschermt.

Couvercle robuste pour le  
S6835 qui protège la base de  
l'anse et l'entrée de la clé.

S101C0V

Aluminium sloten

Cadenas en aluminium

### S1100



- Geanodiseerd aluminium huis/  
Beugel versterkt staal
- Corrosiebestendig
- Beugeldiameter 6 mm
- Geleverd met 1 vastzittende sleutel
- Lasergraving en identificatielabels mogelijk

- Corps en aluminium anodisé/  
Anse en acier cémenté
- Résistance à la corrosion
- Anse de 6 mm diamètre
- Avec 1 clé - retenue de clé
- Gravure au laser et labels d'identification possible

Omschrijving / Description	Beugel / Anse		
	25mm	38mm	75mm
Vershillende sleutels Clés différents	S1105	S1106	S1107
Gelijke sleutels S'ouvrant	S1105KA	S1106KA	S1107KA
Hoofdsleutel Passe-partout	S1105MK	S1106MK	S1107MK
Gelijke sleutels en hoofdsleutel S'ouvrant et passe-partout	S1105KAMK	S1106KAMK	S1107KAMK

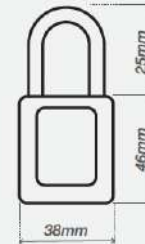

9 beschikbare kleuren - De gewenste kleurcode toevoegen aan het artikelnummer  
9 couleurs disponibles - Ajouter le suffixe de la couleur souhaitée au code d'article

Robuuste weerbestendige kap voor de S1100 die de beugelbasis en het sleutelgat beschermt.

Couvercle robuste pour le S1100 qui protège la base de l'anse et l'entrée de la clé.



S101C0V

Stalen sloten

Cadenas en acier

### 3



- Gelamineerd stalen huis / Beugel geplateerd staal
- Beugeldiameter 7 mm
- Geleverd met 2 niet-vastzittende sleutels
- Geen graving mogelijk

- Corps en acier laminé / Anse chromé en acier
- Anse de 7 mm diamètre
- Avec 2 clés - sans retenue de clé
- Gravure au laser non possible

Omschrijving / Description	Beugel / Anse		
	19mm	38mm	51mm
Vershillende sleutels Clés différents	3	3LF	3LH
Gelijke sleutels S'ouvrant	3KA		3KALH
Hoofdsleutel Passe-partout	3MK	3MKLF	3MKLH
Gelijke sleutels en hoofdsleutel S'ouvrant et passe-partout	3KAMK	3KAMKLF	3KAMKLH

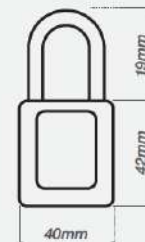

6 beschikbare kleuren - De gewenste kleurcode toevoegen aan het artikelnummer  
6 couleurs disponibles - Ajouter le suffixe de la couleur souhaitée au code d'article



Label 110x20mm voor  
Type 3 stalen sloten

Per /Par 50

NL 461N

Label 110x20mm pour  
Cadenas en acier Type 3

FR 461F

ENG 461

### Slotvermeerderaars

### Crochets multi-points



- Vergrendeling door meerdere sloten op 1 vergrendelingspunt.
- Verhoogde beveiliging en controle
- Het bedieningselement blijft vergrendeld tot het slot van de laatste medewerker is verwijderd.
- Beschikbaar in diverse uitvoeringen en materialen.

- Consignation simultanée sur un même équipement par plusieurs employées.
- Contrôle et sécurité améliorées
- L'élément de contrôle reste condamné jusqu'à l'élimination du cadenas du dernier employé.
- Disponibles en diverses conceptions et matériaux.



- Aluminium
- Vinyl bekleding op handvat
- Binnendiam. 25mm
- Voor 6 sloten

- Aluminium
- Revêtement vinyle sur la poignée
- Diam. intérieur mâchoire 25mm
- Pour 6 cadenas

416



- Aluminium
- Vinyl bekleding op handvat
- Binnendiam. 38mm
- Voor 6 sloten

- Aluminium
- Revêtement vinyle sur la poignée
- Diam. intérieur mâchoire 38mm
- Pour 6 cadenas

417



- Staal
- Vinyl bekleding op handvat
- Binnendiam. 25mm
- Voor 6 sloten

- Acier
- Revêtement vinyle sur la poignée
- Diam. intérieur mâchoire 25mm
- Pour 6 cadenas

420



- Staal
- Vinyl bekleding op handvat
- Binnendiam. 38mm
- Voor 6 sloten

- Acier
- Revêtement vinyle sur la poignée
- Diam. intérieur mâchoire 38mm
- Pour 6 cadenas

Rood / Rouge

421



- Staal
- Vinyl bekleding op handvat
- Binnendiam. 25mm
- Voor 6 sloten

- Acier
- Revêtement vinyle sur la poignée
- Diam. intérieur mâchoire 25mm
- Pour 6 cadenas

ALO80



- Staal
- Vinyl bekleding op handvat
- Binnendiam. 38mm
- Voor 6 sloten

- Acier
- Revêtement vinyle sur la poignée
- Diam. intérieur mâchoire 38mm
- Pour 6 cadenas

ALO802



- Staal
- Binnendiam. 25mm
- Voor 4 sloten

- Acier
- Diam. intérieur mâchoire 25mm
- Pour 4 cadenas

418



- Zenex huis/stalen beugel
- Binnendiam. 25mm
- Voor 2 sloten

- Corps Zenex/anse en acier
- Diam. intérieur mâchoire 25mm
- Pour 2 cadenas

Zone 2

S430



- Staal
- Binnendiam. 25mm
- Voor 8 sloten

- Acier
- Diam. intérieur mâchoire 25mm
- Pour 8 cadenas

419



- Aluminium
- Voor 8 sloten

- Aluminium
- Pour 8 cadenas

429



- Aluminium anod. en RVS
- Mogelijkheid identificatie
- Formaat 44x54mm
- Voor 5 sloten

- Aluminium anod. et Inox
- Possibilité identification
- Dimensions 44x54mm
- Pour 5 cadenas

427RED



- Nylon
- Binnenmaat 25x63mm
- Voor 6 sloten
- Voor elektrische toepassingen

- Nylon
- Diam. intérieur mâchoire 25x63mm
- Pour 6 cadenas
- Pour les applications électriques

428

### Toebehoren

### Accessoires

Bewaar uw slot dicht bij het lock-out punt  
Garder votre cadenas proche de votre point lock-out

Bevestig uw slot dicht bij het lock-out punt  
Fixer votre cadenas proche de votre point lock-out



- Gegalvaniseerde stalen ketting
- Met kettinghouder
- Past voor alle Masterlock bevestigingskragen
- Verpakt per 12 stuks
- Chaîne en acier zingué
- Avec support de chaîne intégré
- S'adapte à l'ensemble des bagues d'anse Masterlock
- Emballé par 12 pièces

- Bevestigingskraag
- Voor diverse diam. sloten
- Verpakt per 12 stuks

- Bevestigingslijn
- Lengte aanpasbaar van 50 tot 900mm
- Compatibel met diverse sloten

- Bague d'anse
- Pour cadenas diam. divers
- Emballé par 12 pièces

- Corde de fixation
- Longueur ajustable de 50 à 900mm
- Compatible avec tant de cadenas

	229mm
Lightweight	71CS
Heavy duty	71CH

	Diam.		
	4,75mm	6,35mm	7,10mm
	71SC7	71SC8	71SC9

S100

Voorkom dat men een lock-out punt vergeet  
Prévenez qu'on oublie un point lock-out

Identificeer uw slot met een graveerbaar label  
Identifiez votre cadenas avec un label engravable



- Hangslotendrager Zenex
- Voorzien van beschrijfbaar infolabel
- Tot 12 sloten
- Poignée de consignation Zenex
- Avec étiquette inscriptible
- Jusqu'à 12 cadenas

- Messing graveerbaar label
- Ring ingegrepen
- Verpakt per 12 stuks
- Tag gravable en laiton
- Anneau de fixation inclus
- Emballé par 12 pièces

S125

13x44mm

71TAG

### Lock-out stations

### Stations lock-out



Polycarbonaat - Polycarbonat  
Met deksel - Avec couvercle  
406x311x44mm

Leeg/Vide 1482B  
Zenex 1482BP410

- 4 sloten
- 2 slotvermeeders 420
- 12 tags 497A

- 4 cadenas
- 2 crochets multi-points 420
- 12 tags 497A



Polycarbonaat - Polycarbonat  
Met deksel - Avec couvercle  
558x393x44mm

Leeg/Vide 1483B  
Aluminium 1483BP1106

- 10 sloten
- 2 slotvermeeders 420
- 24 tags 497A

- 10 cadenas
- 2 crochets multi-points 420
- 24 tags 497A



Polycarbonaat - Polycarbonat  
Met deksel - Avec couvercle  
558x558x44mm

Leeg/Vide 1484B  
Zenex 1484BP410

- 20 sloten
- 4 slotvermeeders 420
- 48 tags 497A

- 20 cadenas
- 4 crochets multi-points 420
- 48 tags 497A



De sloten hebben allemaal verschillende sleutels.  
Lock-out stations voorzien van sloten met gelijke sleutels of met een looper zijn mogelijk op aanvraag. Contacteer ons.

Les cadenas ont tous des clés différentes.  
Stations lock-out prévues de cadenas avec les mêmes clés ou un passe-partout sont possible sur demande. Contactez nous.



Polycarbonaat - Polycarbonat  
Met deksel - Avec couvercle  
596x393x114mm

Leeg/Vide S1850  
Zenex S1850E410

- 6 sloten - 6 cadenas
- 1x420
- 1x427

- 1xS2005
- 1x488
- 2x491B

- 4x493B
- 2x496B
- 24 tags 497A



Polycarbonaat - Polycarbonat  
Zonder deksel - Sans couvercle  
146x247x38mm

Leeg/Vide S1601



Polycarbonaat - Polycarbonat  
Met deksel - Avec couvercle  
596x685x114mm

Leeg/Vide S1900  
Zenex S1900VE410

- 6 sloten - 6 cadenas
- 2x420
- 1x427
- 1xS806

- 1x480,481
- 1x482,483
- 1x468L,488
- 1xS3068MLP,S2005

- 2x491B,496B
- 6x493B
- 24 tags 497A

## Lock-out stations

## Stations lock-out

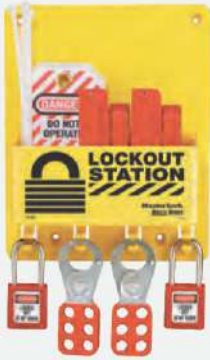

Polycarbonaat - Polycarbonat  
Zonder deksel - Sans couvercle  
196x247x85mm

Leeg/Vide	S1700
Zenex	S1720E410
Staal/Acier	S1720E3

- 2 sloten - 2 cadenas
- 2x493B

- 2x491B
- 4 tags 497A



Polycarbonaat - Polycarbonat  
Zonder deksel - Sans couvercle  
196x247x85mm

Leeg/Vide	S1700
-----------	-------



Polycarbonaat - Polycarbonat  
Met deksel - Avec couvercle  
Zonder tags - Sans tags  
558x279x101mm

Leeg/Vide	S1800
-----------	-------



## Slotenrekken

## Etagères à cadenas



- Gepoederlakt metaal
- Voor 6 tot 8 sloten
- Sloten niet inbegrepen

- Métal peint à la poudre
- Pour 6 à 8 cadenas
- Cadenas non-incluse

158mm	
Leeg/Vide	S1506



- Gepoederlakt metaal
- Voor 18 tot 22 sloten
- Sloten niet inbegrepen

- Métal peint à la poudre
- Pour 18 à 22 cadenas
- Cadenas non-incluse

444mm	
Leeg/Vide	S1518



Sloten terug te vinden in onze catalogus vanaf pagina 338.  
Vous trouvez les cadenas dans le catalogue à partir de la page 338.

### Lock-out kits

### Kits lock-out

Zorg ook op verplaatsing voor een goede organisatie van uw lock-out tag-out materiaal.

Gardez aussi sur déplacement l'organisation de votre matériel lock-out tag-out.

### Afsluitervergrendelingen - Consignations vannes



Leeg/Vide S1017



Leeg S1017  
Aluminium 1457V1106KA

- 3 sloten - Gelijke sleutels
- 3 cadenas - Clés identiques
- 1x 420
- 1x 427
- 1x S806
- 1x 480
- 1x 481
- 1x 482
- 1x 468L
- 1x S3068MLP
- 12 tags 497A

### Elektrische toepassingen - Applications électriques



Leeg/Vide S1017  
Zenex S1117ES31KA

- 3 sloten S31 - Gelijke sleutels
- 3 cadenas S31 - Clés identiques
- 1x S806
- 2x 420
- 1x 491B
- 3x S2390
- 2x S2393



Leeg S1017  
Zenex 1457E410KA  
Staal/Acier 1457E3KA

- 3 sloten - Gelijke sleutels
- 3 cadenas - Clés identiques
- 1x 7C5RED
- 1x 420
- 1x 427
- 2x 491B
- 3x 493B
- 1x 496B
- 12 tags 497A

### Afsluitervergrendelingen / Elektrische toepassingen - Consignations vannes et électriques



Leeg/Vide S1017  
Zenex S1117VES31KA

- 6 sloten S31 - Gelijke sleutels
- 6 cadenas S31 - Clés identiques
- 3x S806
- 2x 420
- 1x 480
- 1x 481
- 1x 482
- 1x S3068MLP
- 6x S2390
- 2x S2393



Leeg S1017  
Zenex 1457VE410KA

- 3 sloten - Gelijke sleutels
- 3 cadenas - Clés identiques
- 1x 7C5RED
- 1x S806
- 1x 480
- 1x 481
- 1x 482
- 2x 491B
- 3x 493B
- 1x 420
- 1x 427
- 1x 468L
- 1x S3068MLP
- 1x 496B
- 12 tags 497A



Stevige koffer van 420x230x216mm. Afsluitbaar met een slot voorzien van een beugel van max. 6mm diameter.  
Boîte à outils robuste de 420x230x216mm. A fermer avec un cadenas prévue d'un bride de 6mm diamètre max.

### Lock-out Kits

### Kits lock-out

#### Elektrische toepassingen - Applications électriques



Leeg/Vide 1458  
Zenex 1458E410

- 6 sloten - Gelijke sleutels
- 6 cadenas - Clés identiques
- 1x S2390
- 1x S2393
- 1x 420
- 1x 427
- 1x S806
- 1x 487
- 1x 488
- 1x 493B
- 1x 491B
- 1x 496B
- 24 tags 497A



Draagtas van 381x17x241mm, voorzien van 2 plastic dozen met indeling voor verschillende toepassingen.  
Sac portatif de 381x17x241mm avec 2 boîtes en plastic avec rangement pour applications divers.

Zorg ervoor dat uw werknemer het nodige lock-out / tag-out materiaal steeds op zak heeft.

Equipez votre employeur toujours avec le matériel lock-out / tag-out nécessaire.

#### Elektrische toepassingen Applications électriques



- 2 sloten - Gelijke sleutels
- 2 cadenas - Clés identiques
- 1x S2393
- 1x 493B
- 1x S428
- 1x S2390
- 1x S2391
- 1x S2392
- 1x S430
- 2 tags 497A/B/C

Leeg/Vide 1456  
Zenex 1456E406KA

#### Elektrische toepassingen Applications électriques



- 1 slot
- 1 cadenas
- 1x 7C5RED
- 1x 491B
- 1x 420
- 2x 493B
- 12 tags 497A

Leeg/Vide 1456  
Zenex 1456E410

#### Algemeen onderhoud Maintenance générale



- 3 sloten - Gelijke sleutels
- 3 cadenas - Clés identiques
- 1x 420
- 12 tags 497A

Leeg/Vide 1456  
Aluminium 1456P1106KA

#### Elektrische toepassingen - Applications électriques



- 1 slot
- 1 cadenas
- 1x 7C5RED
- 1x 420
- 2x 493B
- 1x 491B
- 12 tags 497A

Leeg/Vide S1010  
ZenexS31 S1010ES31  
ZenexH0 S1010E410



Handige heuptas met riem, voorzien van 1 compartiment.  
Sac à fermetures et ceinture, prévu d'un compartiment.

### Roterende kraanvergrendelaars

### Condammation de vannes réglables



- Lichtgewicht Zenex behuizing
- Bestand tegen chemische invloeden
- Ruimtebesparend opbergmechanisme
- Poids-plume, corps en Zenex
- Résistant aux produits chimiques
- Mécanisme de rangement économique



Voor kranen van 25 tot 76mm (1"-3")  
Pour vannes de 25 à 76mm (1"-3")

480



Voor kranen van 50 tot 127mm (2"-5")  
Pour vannes de 50 à 127mm (2"-5")

481



Voor kranen van 101 tot 165mm (4"-6,5")  
Pour vannes de 101 à 165mm (4"-6,5")

482



Voor kranen van 152 tot 254mm (6"-10")  
Pour vannes de 152 à 254mm (6"-10")

483



Voor kranen van 203 tot 330mm (8"-13")  
Pour vannes de 203 à 330mm (8"-13")

484



### Vergrendeling van schuifafsluiters onder druk

### Consignation de vannes de gaz sous pression



S3910

- Voor gasafsluiters onder druk
- Past op nagenoeg alle gasafsluiters onder druk tot 76mm diam.
- Pour vannes de gaz sous pression
- S'adapte potentiellement à toutes les vannes de gaz sous pression jusqu'à 76mm diam.

## Vergrendeling afsluiters

## Consignation de vannes



Aanpasbare kabelvergrendeling  
Vergrendeling mogelijk tot 4 sloten  
Condamnation à câble ajustable  
Possible d'utiliser vers 4 cadenas



Regelbare stalen kabelvergrendeling  
Câble de consignation en acier réglable

610mmx4mm diam.	S806CBL2
910mmx4mm diam.	S806CBL3
1,2mx4mm diam.	S806CBL4
1,5mx4mm diam.	S806CBL5
1,8mx4mm diam.	S806
3,6mx4mm diam.	S806CBL12
4,5mx4mm diam.	S806CBL15
9mx4mm diam.	S806CBL30



Oprolbare kabelvergrendeling, verstelbare kabel  
Dispositif de consignation avec câble rétractable

kern/corps	staal/acier	nylon
2,74 mx3,3 mm diam.	S856	S866

### Combineer diverse producten voor een optimale lock-out.

### Combinez différents produits pour un lock-out optimal



S806 en 491B  
S806 et 491B



S806CBL3 en S3920  
S806CBL3 et S3920



S3920

- Voor vlinderklep met hoek van 16° tot 35°
- Steeds in combinatie met een artikel uit de S806 reeks
- Pour vanne papillon avec coin de 16° à 35°
- Toujours en combinaison avec un article de la série S806



S3921 (= S3920 + S806)



- Voor kwartslagafsluiters van 13 tot 51mm
- De 4 poten passen om de buis
- Zenex behuizing
- Pour vanne 1/4 de tour de 13 à 51mm
- Dispositif de consignation à 4 pieds
- Corps en Zenex

13 - 51mm	S3080
25 - 51mm	S3081





S3068



- Vergrendeling voor kogelkranen met hendel
- Past op kogelkranen van 6 tot 100mm
- Huis van aluminium en staal
- Consignation de vannes 1/4 de tour
- Convient aux vannes de 6 à 100mm
- Corps en aluminium et acier



Past op kranen van 6,35mm-25mm  
s'Adapte aux vannes de 31mm-76mm

S3476

S3477



- Vergrendeling voor kogelkranen
- Poedergelakt lichaam
- Consignation de vannes 1/4 de tour
- Corps en métal renforcé



468L



- PVC polyëster en HDPE plastic
- Voor kranen van 10 tot 100mm
- Opberging hendel
- Voor moeilijk bereikbare kranen
- Bestand tegen chemische invloeden, koude en hitte
- PVC polyëstre et HDPE plastique
- Pour vannes de 10 à 100mm
- Rangement clapet
- Pour vannes isolées ou difficilement accessible
- Résistant aux produits chimiques, chaleur et au froid



Small S3922  
Medium S3923  
Large S3924



- Vergrendeling voor blindflens
- Moeren van 19 tot 70 mm afdekken
- Verstelbare vergrendeling
- Système de consignation pour bride pleine
- Verrouiller les boulons de 19 à 70mm
- Le système réglable permet un ajustement optimal

### Pneumatische vergrendeling

### Condamnation pneumatique



S3900

- Voorkomt heraan koppelen pneumatisch aansluitstuk
- Past op nagenoeg alle mannelijke aansluitstukken
- RVS staal - corrosiebestendig
- 35x197x3mm
- Empêche le rebranchement d'un raccord pneumatique
- S'adapte à presque tous types de raccord pneumatique
- Acier inoxydable - résistant à la corrosion
- 35x197x3mm



### Vergrendeling voor stroomonderbrekers

### Bloques disjoncteurs

- Zorg voor een goede vergrendeling van uw stroomonderbrekers
- Met schakelopeningen voor diverse modellen
- Steeds gebruiken in combinatie met een hangslot



S2390



S2394

- Assurez vous d'un condamnation complète de votre bloques disjoncteur
- Pour différents modèles de disjoncteurs à maneton
- Toujours à utiliser en combinaison avec un cadenas



S2390

- Voor stroomonderbrekers met schakelopeningen van 11mm of minder.
- Pour disjoncteurs à maneton de 11mm ou moins



S2391

- Voor stroomonderbrekers met schakelopeningen van meer dan 11mm
- Pour disjoncteurs à maneton de plus de 11mm.



S2392

- Voor stroomonderbrekers met vergrendelingspunten op het buitenste gedeelte van de schakelhefboom.
- Pour disjoncteurs munis de points de consignation sur la partie extérieure du maneton.



S2393

- Past op bijna alle miniatuur stroomonderbrekers, aan te brengen op de schakelhefboom door het vastdraaien van de schroef.
- S'applique à presque tous disjoncteurs miniatures. Fixation à l'aide d'une vis intégrée au bloqué disjoncteur.



S2394

- Past op bijna alle stroomonderbrekers, gemakkelijk aan te brengen op de schakelhefboom door het vastdraaien van de schroef.
- S'applique à presque tous disjoncteurs. Fixation simple et sûre à l'aide d'une vis intégrée au bloqué disjoncteur.



S3821

- Vergrendeling voor stroomonderbreker in miniaturuitvoering (120/240 V).
- Bloque-disjoncteur pour disjoncteur miniature (120/240 V).



S3822

- Vergrendeling voor stroomonderbreker in gegoten behuizing (480/600 V).
- Bloque-disjoncteur pour disjoncteur à boîtier moulé (480/600 V).



S3823

- Vergrendeling voor stroomonderbreker met overgrote hendel (480/600 V).
- Bloque-disjoncteur pour disjoncteur avec large poignée (480/600 V).



Y491B

- Voor hoge en brede tuimelschakelaars 86x32x26mm
- Pour manetons hauts et larges. 86x32x26mm



Y493B



- Voor enkele en dubbele tuimelschakelaars 72x19x19mm
- Pour manetons simples et doubles standard. 72x19x19mm



S2029



S2329

- Vergrendelingstoepassingen voor gebruik op vliegtuigen.
- Systèmes de condamnation pour usage sur des avions.



S2029



S2329

### Vergrendeling voor stroomonderbrekers

Nog meer oplossingen voor het vergrendelen van stroomonderbrekers?



- Vergrendeling voor tuimel- en wipchakelaar
- Consignation d'interrupteur à levier ou à bascule

496B



- Voor een vergrendeling op beperkte ruimtes
- Pour une consignation sur des espaces limités

7C5RED

### Bloques disjoncteur

Plus de solutions pour le condamnation des disjoncteurs?



- Voor de vergrendeling van startmotoren
- Pour le consignation de disjoncteurs-moteurs

S430



Lockout vergrendeling voor schroefzekering + sleutel

Verrouillage lockout pour fusible à vis avec clé

Lockout / Verrouillage	YDZ2
Sleutel / Clé	DZ3



Gebruik voor het vergrendelen van isolatieschakelaars de sloten van reeks 406-410 of 411.  
Utilise pour la consignation de sectionneurs les cadenas des séries 406-410 ou 411.

### Vergrendelingssystemen



- Vergrendeling voor kleine stroomstekkers
- Past op stekkers met 2 pennen, met of zonder aarding

- Consignation pour petites prises
- S'adapte aux fiches à 2 broches avec ou sans prise de terre

S2005

### Systèmes de condamnation



- Nylon zak voor bedieningen, grote stekkers, e.a.
- Vergrendeling mogelijk met 6 sloten

- Sac en nylon pour commandes, grandes prises, etc.
- Condamnation possible avec 6 cadenas

180x430mm	453L
270x700mm	453XL



- Vergrendeling voor grote stekkers
- Lichtgewicht, Zenex behuizing

- Consignation pour grandes prises
- Poids-plume, corps en Zenex



Voor draadgat 19mm diam.  
Pour trou fil 19mm diam.

55mmdiam.x95mm

487



Voor draadgat 19mm diam.  
Pour trou fil 19mm diam.

75mmdiam.x180mm

488

## Beschermkappen

## Capots de protection

- Ontworpen voor een veiligere afsluiting van stroombronnen
- Sterk transparant huis
- Deze artikelen zijn beschermkappen, geen vergrendelingen

- Conçus pour renforcer la sécurité de toute isolation d'énergie
- Corps résistant transparent
- Il ne s'agit pas de dispositifs de consignation, mais de capots de protection



Verwijderbare beschermkap  
Capot de protection amovible

Voor drukknopen tot Ø40mm en 45mm hoog  
Compatible avec des boutons jusqu'à Ø40mm  
et 45mm de hauteur

S2151



Vaste beschermkap  
Capot de protection permanent

Voor drukknopen tot Ø50mm en 45mm hoog  
Compatible avec des boutons jusqu'à Ø50mm  
et 45mm de hauteur

S2153



## Sleutelbeheerkasten

## Boîtes de condamnation

- Vereenvoudigt het vergrendelen van grote uitrustingen
- De sleutels worden in de box bewaard

- Simplifie la condamnation de grands équipements
- Les clés sont mises dans la boîte



12 sleutelhaakjes - muurmontage mogelijk  
Vergrendelbaar met 14 sloten  
12 crochets de clés - montage mural possible  
Verrouillable par 14 cadenas

169x324x89mm 503RED



12 sleutelhaakjes - muurmontage mogelijk  
Vergrendelbaar met 14 sloten  
12 crochets de clés - montage mural possible  
Verrouillable par 14 cadenas

169x324x89mm 503YLW



Vergrendelbaar met 12 sloten  
Verrouillable par 12 cadenas

235x152x95mm 498A

### Sleutelbeheerkasten

- Vereenvoudigt het vergrendelen van grote uitrustingen
- De sleutels worden in de box bewaard



### Boîtes de condamnation

- Simplifie la condamnation de grands équipements
- Les clés sont mises dans la boîte



Werkvergunningstation van rvs Centre de consignation en acier inoxydable		Display voor station s3500 Panneau d'affichage pour station s3500		Groepsvergrendelingskast van rvs Boîte de consignation en acier inoxydable	
308x789x199mm	S3500	308x441x119mm	S3501	308x348x119mm	S3502

- 12 genummerde slotopeningen voor persoonlijke veiligheidsloten
- Met displaybord voor formaat tot A3 (297x420 mm)
- 12 trous numérotés pour cadenas personnels
- Avec panneau d'affichage pour les formats jusqu'à A3 (297x420 mm)

- 12 genummerde slotopeningen voor persoonlijke veiligheidsloten
- 12 trous numérotés pour cadenas personnels



S3500



S3650



S600



Groepsvergrendelingskast van rvs Boîte de consignation en acier inoxydable		Groepsvergrendelingskoffer boîte de verrouillage de groupe	
212x175x100mm	S3650	144x163x306mm	S600

- Vergrendelbaar met 8 sloten
- Opbergruimte voor 15 veiligheidshangsloten.
- 4 sleutelhaken

- Verrouillable par 8 cadenas
- Espace de rangement pour 15 cadenas.
- 4 crochets à clés

- 144x163x306mm S601 (extra venster/vitre)
- 203x163x308mm S602

- Vergrendelbaar met 18 sloten

- Verrouillable par 18 cadenas

## Hangslotlabels

## Etiquettes d'identification de cadenas



- Labels voor reeks S31, S32, 406 en 410
- Etiquettes pour série S31, S32, 406 et 410

ENG/ANGL, FR, SPA/ESP S140



- Labels voor reeks 411
- Etiquettes pour série 411

ENG/SPA + ENG/FR  
ANGL/ESP + ANGL/FR S141



6835-5700

- Label met foto-ID mogelijk op aanvraag
- Etiquette avec photo-identité possible sur demande



0411-5705



50x NL 461N  
50x FR 461F  
50x ENG/ANG 461

- Labels voor reeks 3 en 6835
- Etiquettes pour série 3 et 6835

## Identificatie voor vergrendelingspunt

## Identification pour lock-out

Gelamineerde polypropyleen tags  
75x40x1mm

Tags en propylène laminé  
75x40x1mm



Controlepaneel / Panneau de contrôle  
392L.01MT



Stoom / Vapeur  
392L.02MT



Stoom / Vapeur  
392L.03MT



Elektrisch / Électrique  
392L.04MT



Gas / Gaz  
392L.05MT



Ventiel / Vanne  
392L.06MT



Pneumatisch / Pneumatique  
392L.07MT



Water / Eau  
392L.08MT

## Waarschuwingstags

## Tags de danger

- 76x146mm
- PP - recto/verso
- Met boring
- Beschrijfbaar met permanente viltstift
- Per 6

- 76x146mm
- PP - recto/verso
- Avec orifice
- A compléter au marqueur permanent
- Par 6



S4331LNL



S4342LNL



S4327LFR

PERMANENT MARKER zwart  
MARQUEUR PERMANENT noir



MARK02



S4331LFR



S4373LFR

## Waarschuwingstags

## Tags de danger

- PP - recto/verso
- Met boring
- Beschrijfbaar met permanente viltstift

- PP - recto/verso
- Avec orifice
- A compléter au marqueur permanent



Verso



Verso



Verso



Verso



Verso

Recto	Verso	Recto	Verso	Recto	Verso	Recto	Verso	Recto	Verso
Per/Par6									
76x146mm	S4302LEN	S4303LEN		S4308LEN		S4325LEN		S4331LEN	



Verso



Verso

Recto	Verso	Recto	Verso
Per/Par6			
76x146mm	S4366LEN	S4367LEN	



Verso



Verso



Verso



Verso



Verso



Verso

Recto	Verso	Recto	Verso	Recto	Verso	Recto	Verso	Recto	Verso
Per/Par6									
76x146mm	S4202LEN	S4203LEN		S4208LEN		S4214LEN		S4225LEN	S4231LEN



Verso



Verso

Recto	Verso	Recto	Verso
Per/Par6			
76x146mm	S4266LEN	S4267LEN	

PERMANENT MARKER zwart  
MARQUEUR PERMANENT noir



MARK02



Verso



Verso



Verso



Verso



Verso

Recto	Verso	Recto	Verso	Recto	Verso	Recto	Verso
Per/Par6							
76x146mm	S4239LEN	S4263LEN		S4264LEN		S4265LEN	S4268LEN

### Waarschuwingstags

### Tags de danger



- Detecteerbare metalen tags
- Ideaal voor voedings- en farmaceutische bedrijven
- Tags identifiables aux détecteurs de métaux
- Idéale pour l'industrie agro-alimentaire et pharmaceutique

Voeg "MET" toe aan de standaard tagcode  
Ajoutez "MET" au code du tag standard

### Gepersonaliseerde tags

### Tags personnalisés



Part2/Part2

80x146mm

S4800LFR

Met transparant zelfklevend plaatje voor personalisering ter plaatse.  
Voorzien van een ring van 9mm diameter.

Avec film adhésif transparent permettant de personnaliser les  
étiquettes sur site.

Avec anneau de 9mm pour une meilleure résistance  
à l'arrachement.

### Lock-out tags

### Tags lock-out



Part2/Part2		80x146mm
Nederlands	NIET BEDIENEN	497NLB
Engels	DO NOT OPERATE	497A
Engels/Frans	DO NOT OPERATE / NE PAS UTILISER	497AF



## Waarschuwingstags

PVC 0,3mm mat - Recto / Verso - Onscheurbaar  
Boring 6,5mm - Rechte hoeken  
Beschrijfbaar met viltstift

## Etiquettes de prévention

PVC 0,3mm mat - Recto / Verso - Indéchirable  
Orifice 6,5mm - Coins rectangulaires  
A compléter au marqueur



Recto	Verso	50x100mm	80x150mm	Recto	Verso	50x100mm	80x150mm	Recto	Verso	50x100mm	80x150mm
Electriciteit niet uitschakelen		8021.01	8022.01	Niet openen		8021.05	8022.05	Niet sluiten		8021.09	8022.09
Défense de couper l'électricité		8021.02	8022.02	Ne pas ouvrir		8021.06	8022.06	Ne pas fermer		8021.10	8022.10
Do not switch off		8021.03	8022.03	Do not open		8021.07	8022.07	Do not close		8021.11	8022.11
3-talig 3langues/3languages			8022.04	3-talig 3langues/3languages			8022.08	3-talig 3langues/3languages			8022.12



Recto	Verso	50x100mm	80x150mm	Recto	Verso	50x100mm	80x150mm	Recto	Verso	50x100mm	80x150mm
Niet gebruiken		8021.13	8022.13	Niet aanraken		8021.17	8022.17	Niet verwijderen		8021.21	8022.21
Ne pas utiliser		8021.14	8022.14	Ne pas toucher		8021.18	8022.18	Défense d'enlever		8021.22	8022.22
Do not use		8021.15	8022.15	Do not touch		8021.19	8022.19	Do not remove		8021.23	8022.23
3-talig 3langues/3languages			8022.16	3-talig 3langues/3languages			8022.20	3-talig 3langues/3languages			8022.24



Recto	Verso	50x100mm	80x150mm	Recto	Verso	50x100mm	80x150mm	Recto	Verso	50x100mm	80x150mm
Niet inschakelen		8021.25	8022.25	Niet bedienen werk in uitvoering		8021.29	8022.29	Niet starten		8021.33	8022.33
Défense d'endecher		8021.26	8022.26	Ne pas démarrer travail en cours		8021.30	8022.30	Nepasmetteenmarche		8021.34	8022.34
Do not operate		8021.27	8022.27	Do not operate under maintenance		8021.31	8022.31	Do not start		8021.35	8022.35
3-talig 3langues/3languages			8022.28	3-talig 3langues/3languages			8022.32	3-talig 3langues/3languages			8022.36

**Waarschuwingstags**

**Etiquettes de prévention**

PVC 0,3mm mat - Recto/Verso - Onscheurbaar  
 Boring 6,5mm - Rechte hoeken  
 Beschrijfbaar met viltstift

PVC 0,3mm mat - Recto/Verso - Indéchirable  
 Orifice 6,5mm - Coins rectangles  
 A compléter au marqueur



Recto	Verso		Recto	Verso		Recto	Verso	
	50x100mm	80x150mm		50x100mm	80x150mm		50x100mm	80x150mm
Machine niet starten	8021.37	8022.37	Niet in werking stellen	8021.41	8022.41	Kraan niet openen	8021.45	8022.45
Défense de démarrer la machine	8021.38	8022.38	Ne pas mettre en marche	8021.42	8022.42	Défense d'ouvrir la vanne	8021.46	8022.46
Do not start engine	8021.39	8022.39	Do not operate	8021.43	8022.43	Do not open valve	8021.47	8022.47
3-talig / 3 langues / 3 languages		8022.40	3-talig / 3 langues / 3 languages		8022.44	3-talig / 3 langues / 3 languages		8022.48



Recto	Verso		Recto	Verso		Verso - Fr.	Verso - Eng.
	50x100mm	80x150mm		50x100mm	80x150mm		
Kraan niet afsluiten	8021.49	8022.49	Niet aanraken- Niet bedienen	8021.53	8022.53		
Défense de fermer la vanne	8021.50	8022.50	Ne pas toucher- Ne pas mettre en marche	8021.54	8022.54		
Do not close valve	8021.51	8022.51	Do not touch or operate	8021.55	8022.55		
3-talig / 3 langues / 3 languages		8022.52	3-talig / 3 langues / 3 languages		8022.56		

Gepersonaliseerde tags op aanvraag.  
 Tags personnalisés sur demande.

**Toebehoren**

**Accessoires**



Permanent marker (zwart)  
 Marqueur permanent (noir)

MARK02



Tang voor kabelbandjes  
 Pince pour colliers de serrage

J542



Kogelketting rvs 2.4 mm op bobijn van 100 meter  
 Chainette à billes inox 2.4 mm en bobine de 100 mètres

B56301



Kabelbandjes Colliers de serrage	
200x3,6mm	
TRSP	8124.01
Blue	8124.02
Red	8124.03
Orange	8124.04
Yellow	8124.05
Green	8124.06
Purple	8124.07
Black	8124.08
Grey	8124.09
Dark Red	8124.10



Sluiting rvs voor kogelketting 2.4 mm  
 Fermoir inox pour chainette à billes 2.4 mm

B56302



Staaldraad 150 mm met schroefsluiting  
 Fil d'acier 150 mm avec fermeture à vis

B56303

## Waarschuwingstags

## Etiquettes de prévention

PVC 0,3mm mat - Recto/Verso - Onschuurbaar  
Boring 6,5mm - Rechte hoeken  
Beschrijfbaar met viltstift

PVC 0,3mm mat - Recto/Verso - Indéchetable  
Orifice 6,5mm - Coins rectanglés  
A compléter au marqueur



Recto



Verso



Recto



Verso



Recto



Verso

	50x100mm	80x150mm		50x100mm	80x150mm		50x100mm	80x150mm
Machine uitgeschakeld door	8621.A1	8622.A1	Label en slot uitsl. verwijderd door	8621.A5	8622.A5	Machine vergrendeld voor veiligheid	8621.A9	8622.A9
Hors service raison	8621.A2	8622.A2	Condamnation/étiquette enlevée que par	8621.A6	8622.A6	Machine hors service pour la sécurité	8621.B1	8622.B1
Equipment locked out by	8621.A3	8622.A3	Tag & lock to be removed only by	8621.A7	8622.A7	Equipment locked out to protect workers	8621.B2	8622.B2
3-talig/3 langues/3 languages	8621.A4	8622.A4	3-talig/3 langues/3 languages	8621.A8	8622.A8	3-talig/3 langues/3 languages	8621.B3	8622.B3



Recto



Verso



Recto



Verso



Verso Fr.



Verso Eng.

	50x100mm	80x150mm		50x100mm	80x150mm
Niet bedienen	8621.B4	8622.B4	Verboden in te schakelen	8621.B8	8622.B8
Ne pas toucher	8621.B5	8622.B5	Défense d'enclencher tant que étiquette	8621.B9	8622.B9
Do not operate	8621.B6	8622.B6	Do not operate as long as tag is not removed	8621.C1	8622.C1
3-talig/3 langues/3 languages	8621.B7	8622.B7	3-talig/3 langues/3 languages	8621.C2	8622.C2



MACHINE  
IN ONDERHOUD



NIET BEDIENEN

Magnetisch waarschuwingslabel  
Etiquette de prévention aimante

105x148mm

1701.F9

BEWAAR UW TAGS DICHT BIJ HET LOCK-OUT PUNT

GARDEZ VOS TAGS PROCHE DU POINT LOCK-OUT



TAGHOUDERS OP PAGINA 208 EN 209



PORTE TAGS À LA PAGE 208 ET 209

**Waarschuwingstags**

**Etiquettes de prévention**

LABELS MET TE SLUITEN BEVESTIGING  
 PVC 0,3mm mat - Recto/Verso - Onscheurbaar  
 Beschrijfbaar met viltstift  
 Bevestiging < Ø 33mm

MARQUAGE AVEC FIXATION A FERMER  
 PVC 0,3mm mat - Recto/Verso - Indéchirable  
 A compléter au marqueur  
 Fixation < Ø 33mm

<b>GEVAAR</b> NIET INSCHAKELEN! AAN DEZE INSTALLATIE WORDT GEWERKT	<b>GEVAAR</b> DIT LABEL NIET WEDEROM NEMEN	<b>BUITEN DIENST</b> NIET GEBRUIKEN	DIT LABEL GEEFT OP DE OMMEZIJDE BELANGRIJKE INFORMATIE Z.O.Z.	<b>KRAAN NIET AFSLUITEN</b>	DIT LABEL GEEFT OP DE OMMEZIJDE BELANGRIJKE INFORMATIE Z.O.Z.	<b>KRAAN DICHT LATEN</b>	DIT LABEL GEEFT OP DE OMMEZIJDE BELANGRIJKE INFORMATIE Z.O.Z.
<b>Recto</b>	<b>Verso</b>	<b>Recto</b>	<b>Verso</b>	<b>Recto</b>	<b>Verso</b>	<b>Recto</b>	<b>Verso</b>
85x275mm		85x275mm		85x275mm		85x275mm	
Gevaar niet inschakelen 39M701		Buiten dienst 39M702		Kraan niet afsluiten 39M703		Kraan dicht laten 39M704	

<b>ONDER SPANNING</b>	DIT LABEL GEEFT OP DE OMMEZIJDE BELANGRIJKE INFORMATIE Z.O.Z.	<b>IN ONDERHOUD</b>	DIT LABEL GEEFT OP DE OMMEZIJDE BELANGRIJKE INFORMATIE Z.O.Z.	<b>IN BEDRIJF LATEN</b>	DIT LABEL GEEFT OP DE OMMEZIJDE BELANGRIJKE INFORMATIE Z.O.Z.	<b>GEVAAR...</b>	DIT LABEL GEEFT OP DE OMMEZIJDE BELANGRIJKE INFORMATIE Z.O.Z.
<b>Recto</b>	<b>Verso</b>	<b>Recto</b>	<b>Verso</b>	<b>Recto</b>	<b>Verso</b>	<b>Recto</b>	<b>Verso</b>
85x275mm		85x275mm		85x275mm		85x275mm	
Onder spanning 39M705		In onderhoud 39M706		In bedrijf laten 39M707		Gevaar 39M708	

<b>ONVEILIG</b>	DIT LABEL GEEFT OP DE OMMEZIJDE BELANGRIJKE INFORMATIE Z.O.Z.	<b>NIET INSCHAKELEN</b>	DIT LABEL GEEFT OP DE OMMEZIJDE BELANGRIJKE INFORMATIE Z.O.Z.	<b>NIET IN WERKING STELLEN</b>	DIT LABEL GEEFT OP DE OMMEZIJDE BELANGRIJKE INFORMATIE Z.O.Z.
<b>Recto</b>	<b>Verso</b>	<b>Recto</b>	<b>Verso</b>	<b>Recto</b>	<b>Verso</b>
85x275mm		85x275mm		85x275mm	
Onveilig 39M709		Niet inschakelen 39M710		Niet in werking stellen 39M711	

ANDERE TEKSTEN OP AANVRAAG  
 AUTRES TEXTES SUR DEMANDE

Waarschuwingstags

Etiquettes de prévention

LABELS MET TE SLUITEN BEVESTIGING  
PVC 0,3mm mat - Recto/Verso - Onscheurbaar  
Beschrijfbaar met viltstift  
Bevestiging < Ø 33mm

MARQUAGE AVEC FIXATION A FERMER  
PVC 0,3mm mat - Recto/Verso - Indéchirable  
A compléter au marqueur  
Fixation < Ø 33mm

<b>Recto</b>	<b>Verso</b>	<b>Recto</b>	<b>Verso</b>	<b>Recto</b>	<b>Verso</b>	<b>Recto</b>	<b>Verso</b>
85x275mm		85x275mm		85x275mm		85x275mm	
Danger défense d'enclencher		39M712		Danger défense d'enclencher		39M726	
				Hors service		39M713	
						Ne pas toucher	
						39M714	

<b>Recto</b>	<b>Verso</b>	<b>Recto</b>	<b>Verso</b>	<b>Recto</b>	<b>Verso</b>	<b>Recto</b>	<b>Verso</b>
85x275mm		85x275mm		85x275mm		85x275mm	
Défense de fermer la vanne		39M715		Défense d'ouvrir la vanne		39M716	
				En cours entretien		39M717	
						Maintenir en service	
						39M718	

<b>Recto</b>	<b>Verso</b>	<b>Recto</b>	<b>Verso</b>	<b>Recto</b>	<b>Verso</b>	<b>Recto</b>	<b>Verso</b>
85x275mm		85x275mm		85x275mm		85x275mm	
Sous tension		39M719		Danger...		39M720	
				Haute tension		39M721	
				Danger de mort			
						Ne pas mettre en marche	
						39M722	

ANDERE TEKSTEN OP AANVRAAG / AUTRES TEXTES SUR DEMANDE

## Afscheurbare labels

PVC 0,3mm mat - Recto  
Beschrijfbaar met viltstift  
Boring 6,5mm



75x200mm  
8222.01



75x200mm  
8222.02



75x200mm  
8322.03



75x200mm  
8322.04



75x200mm  
8322.05



75x200mm  
8322.06

## Etiquettes arrachables

PVC 0,3mm mat - Recto  
A compléter au marqueur  
Orifice 6,5mm

## Afscheurbare gasfleslabels

PVC 0,3mm mat - Recto  
Beschrijfbaar met viltstift



175x180mm  
8523.01



175x180mm  
8523.02

## Etiquettes arrachables pour cylindres

PVC 0,3mm mat - Recto  
A compléter au marqueur

PERMANENT MARKER zwart  
MARQUEUR PERMANENT noir



MARK02

## Inspectietags

PVC 0,3mm mat - Recto - Onscheurbaar  
Bevestigingsgaatje 6,5mm - Beschrijfbaar met viltstift

**KWALITEIT OK**  
Opmerkingen:

Naam: \_\_\_\_\_  
Datum: \_\_\_\_\_  
Handtekening: \_\_\_\_\_  
Dienst: \_\_\_\_\_  
Telefoon: \_\_\_\_\_

	OK (NL)	OK (Fr)	Kwaliteit OK	Qualité OK	Goedgekeurd	Conform
80x150mm	8722.K1	8722.K2	8722.K3	8722.K4	8722.K5	8722.K6

## Etiquettes d'inspection

PVC 0,3mm mat - Recto - Indéchirable  
Orifice 6,5mm - A compléter au marqueur

**GOEDGEKEURD**  
Opmerkingen:

Naam: \_\_\_\_\_  
Datum: \_\_\_\_\_  
Handtekening: \_\_\_\_\_  
Dienst: \_\_\_\_\_  
Telefoon: \_\_\_\_\_

8722.K5

**INSPECTIE**  
Opmerkingen:

Naam: \_\_\_\_\_  
Datum: \_\_\_\_\_  
Handtekening: \_\_\_\_\_  
Dienst: \_\_\_\_\_  
Telefoon: \_\_\_\_\_

8722.K9

**EN REPARATION**  
Remarques:

Norm: \_\_\_\_\_  
Date: \_\_\_\_\_  
Signature: \_\_\_\_\_  
Service: \_\_\_\_\_  
Telephone: \_\_\_\_\_

	In reparatie	En réparation	Inspectie	Inspection	Afgekeurd	Non conform
80x150mm	8722.K7	8722.K8	8722.K9	8722.M1	8722.M2	8722.M3

	Veiligheids- controle	Contrôle de sécurité	Herstellen	A reparer	Geweigerd	Réfusé	Te controleren	A contrôler
80x150mm	8722.M4	8722.M5	8722.M6	8722.M7	8722.M8	8722.M9	8722.N1	8722.N2

**Zelfklevende labels**

**Etiquettes autocollantes**

Vinyl mat  
Beschrijfbaar met balpen en viltstift

Vinyle mat  
A compléter au stylo et marqueur fin



	70x70mm	100x100mm		70x70mm	100x100mm		70x70mm	100x100mm
Niet gebruiken	8431.01	8432.01	Niet inschakelen	8431.03	8432.03	Gevaar Machine in herstelling	8431.05	8432.05



	70x70mm	100x100mm		70x70mm	100x100mm		70x70mm	100x100mm
Ne pas utiliser	8431.02	8432.02	Ne pas enclencher	8431.04	8432.04	Danger Machine en réparation	8431.06	8432.06

**Identificatielabels**

**Tags d'identification**

PP 1,5mm - Recto - Boring 6,5mm

PP 1,5mm - Recto - Orifice 6,5mm

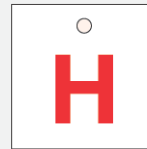
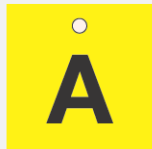

50x50mm		50x50mm		50x50mm		50x50mm
A 3929A	1	3929.1	A 392.AA	1	392A.1	
B 3929B	2	3929.2	B 392.AB	2	392A.2	
C 3929C	3	3929.3	C 392.AC	3	392A.3	
D 3929D	4	3929.4	D 392.AD	4	392A.4	
Z 3929Z	200	3929.200	Z 392.AZ	200	392A.200	

**Blanco labels**

**Etiquettes blanco**

PVC MAT 0,3mm - Beschrijfbaar - Prijs per stuk

PVC MAT 0,3mm - Permet l'écriture - Prix à la pièce

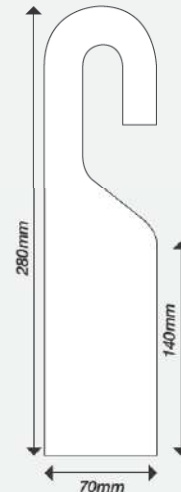
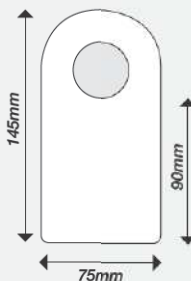
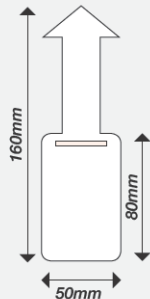
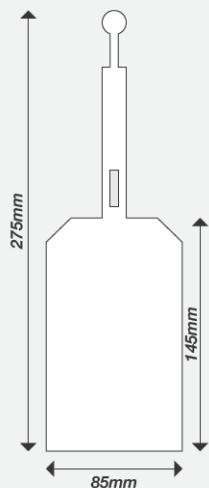

85x275mm	50x160mm	75x145mm	70x280mm
Wit / Blanc 39M501	39M201	39M301	39M601
Blauw / Bleu 39M502	39M202	39M302	
Rood / Rouge 39M503	39M203	39M303	
Oranje / Orange 39M504	39M204	39M304	
Geel / Jaune 39M505	39M205	39M305	39M605
Groen / Vert 39M506	39M206	39M306	
Grijs / Gris 39M507	39M207	39M307	



Prijs met bedrukking op aanvraag.  
Prix avec impression sur demande.

## Blanco labels

## Etiquettes blanco

PVC 0,3mm mat - Beschrijfbaar - Afgeronde hoeken  
Boring diam. 5mm - Verpakt en prijs per 100 stuks

PVC 0,3mm mat - Permet l'écriture - Coins arrondis  
Orifice diam. 5mm - Emballé et prix par 100 pièces



	Wit Blanc	Blauw Bleu	Rood Rouge	Oranje Orange	Geel Jaune	Groen Vert	Grijs Gris
70x45mm	39MA01	39MA02	39MA03	39MA04	39MA05	39MA06	39MA09
100x45mm	39MB01	39MB02	39MB03	39MB04	39MB05	39MB06	39MB09
80x55mm	39MC01	39MC02	39MC03	39MC04	39MC05	39MC06	39MC09
100x55mm	39MD01	39MD02	39MD03	39MD04	39MD05	39MD06	39MD09
125x55mm	39ME01	39ME02	39ME03	39ME04	39ME05	39ME06	39ME09
125x70mm	39MF01	39MF02	39MF03	39MF04	39MF05	39MF06	39MF09

PVC 0,3mm mat - Beschrijfbaar - Boring diam. 5mm - Prijs per stuk

PVC 0,3mm mat - Permet l'écriture - Orifice diam. 5mm - Prix la pièce



	Wit Blanc	Blauw Bleu	Rood Rouge	Oranje Orange	Geel Jaune	Groen Vert	Grijs Gris
Diam. 50mm	392101	392102	392103	392104	392105	392106	392109
Diam. 80mm	392201	392202	392203	392204	392205	392206	392209
Diam. 90mm	392301	392302	392303	392304	392305	392306	392309
Diam. 200mm	392401	392402	392403	392404	392405	392406	392409

PVC 0,3mm mat - Beschrijfbaar - Boring diam. 5mm - Prijs per stuk

PVC 0,3mm mat - Permet l'écriture - Orifice diam. 5mm - Prix la pièce



	Wit Blanc	Blauw Bleu	Rood Rouge	Oranje Orange	Geel Jaune	Groen Vert	Grijs Gris
100x100mm	392501	392502	392503	392504	392505	392506	392509
200x100mm	392601	392602	392603	392604	392605	392606	392609
200x200mm	392701	392702	392703	392704	392705	392706	392709
300x300mm	392801	392802	392803	392804	392805	392806	392809

Vinyl glans - Beschrijfbaar met viltstift - Zonder boring - Prijs per stuk

Vinyle brillante - Permet l'écriture au marqueur - Sans trou - Prix la pièce



	Wit Blanc	Blauw Bleu	Rood Rouge	Oranje Orange	Geel Jaune	Groen Vert	Grijs Gris
Diam. 50mm	393101	393102	393103	393104	393105	393106	393109
Diam. 80mm	393201	393202	393203	393204	393205	393206	393209
Diam. 90mm	393301	393302	393303	393304	393305	393306	393309
Diam. 200mm	393401	393402	393403	393404	393405	393406	393409

Vinyl glans - Beschrijfbaar met viltstift - Zonder boring - Prijs per stuk

Vinyle brillante - Permet l'écriture au marqueur - Sans trou - Prix la pièce



	Wit Blanc	Blauw Bleu	Rood Rouge	Oranje Orange	Geel Jaune	Groen Vert	Grijs Gris
100x100mm	393501	393502	393503	393504	393505	393506	393509
200x100mm	393601	393602	393603	393604	393605	393606	393609
200x200mm	393701	393702	393703	393704	393705	393706	393709
300x300mm	393801	393802	393803	393804	393805	393806	393809

## Toebehoren

## Accessoires



Permanent marker (zwart)  
Marqueur permanent (noir)

MARK02



Tang voor kabelbandjes  
Pince pour colliers de serrage

J542



Kogelketting rvs 2.4 mm op bobijn van 100 meter  
Chaînette à billes inox 2.4 mm en bobine de 100 mètres

B56301



Sluiting rvs voor kogelketting 2.4 mm  
Fermoir inox pour chaînette à billes 2.4 mm

B56302



Kabelbandjes Colliers de serrage	
200x3,6mm	
TRSP	8124.01
Blauw	8124.02
Rood	8124.03
Oranje	8124.04
Geel	8124.05
Groen	8124.06
Purper	8124.07
Zwart	8124.08
Grijs	8124.09
Wit	8124.10



Blanco aluminium ID label  
Blanco étiquette d'identification en aluminium

IDLABEL



Kogelketting 2,4mm + sluiting 100mm  
Chaînette à billes 2,4mm + fermoir 100mm

B56201



## Master Lock Services, un service complet d'audits et de formations

Définir et implanter programme de consignation peut s'avérer complexe et rapidement inefficace s'il est mal géré ou incomplet. C'est pourquoi Master Lock met son expertise au service des entreprises de tous secteurs avec Master Lock Services : un service clé en main qui permet d'implanter un programme de consignation personnalisé à chaque établissement. Notre équipe d'experts en consignation peut contrôler votre structure et s'assurer que votre installation est entièrement conforme aux meilleures pratiques en matière de consignation et ce, via notre formule d'audits, d'aide à la rédaction de procédures de consignation et de formations. Que vous ayez besoin d'améliorer vos procédures existantes ou de développer un tout nouveau programme de consignation, nous pouvons vous aider.

## Field iD, un logiciel unique pour gérer simplement votre programme de consignation

Numérisez vos procédures de consignation : accédez à toutes vos données en temps réel, supprimez la paperasse et gagnez en efficacité ! Suivez vos procédures de consignation sur le terrain de manière simple et rapide :

- Assignez la consignation / déconsignation des équipements aux membres de votre équipe
- Suivez l'exécution des procédures en temps réel sur le terrain
- Recevez instantanément toutes remarques, validations ou demandes de révisions
- Évaluez l'efficacité de vos procédures
- Générez facilement des rapports détaillés

\* Logiciel uniquement disponible en anglais

## Master Lock Services, een volledig programma van audit en opleidingsdiensten

Een succesvol lockout/tagout programma integreren kan complex zijn en snel inefficiënt worden indien het incompleet of slecht beheerd wordt. Daarom brengt Master Lock zijn expertise in veilige isolatiepraktijken naar elke industrie met Master Lock Services : een sleutel-op-de-deur formule die het toelaat een geschikt LOTO-programma op elke site te integreren. Master Lock's team van vergrendelingsexperten kan ervoor zorgen dat uw inrichting een volledig conform programma heeft door onze systematische audits, visuele vergrendelingsprocedure, schrijfproces en opleiding. Of u uw bestaande procedures wilt verbeteren of een volledig nieuw vergrendelingsprogramma dient te ontwikkelen, we kunnen helpen.

## Field- iD, unieke software om uw Lockout/ Tagout programma efficiënter te beheren

Digitaliseer uw procedures op een veilige manier met mobiele apparatuur: toegang tot data in real time, elimineer papierwerk en verbeter doeltreffendheid! Volg uw lockout-inspecties gemakkelijk en snel:

- Wijs lockout/tagout-taken toe aan uw werknemers
- Volg de uitvoering van procedures in real time op het veld
- Ontvang commentaar, validering of herziening aanvragen
- Evalueer de doeltreffendheid van uw procedures
- Genereer gedetailleerde rapporten

\* Enkel beschikbaar in het Engels



# FIELD iD



## Bluetooth gestuurd hangslot

Ideaal voor nutsvoorzieningen, aannemers en distributiecentra

## Cadenas connectés bluetooth

Idéal pour les industries, les sites de construction et les plateformes de distribution



4400 & 4401



De ultra beveiligde Masterlock Vault elocks app kan gratis gedownload worden  
L'application ultra sécurisée Master Lock Vault elocks est téléchargeable gratuitement

Art.Nr.	Body / Corps			Bout / Anse			gewicht poids
	breedte largeur	hoogte hauteur	dikte épaisseur	A	B	C	
4400EURD (indoor)	47mm	50mm	27mm	22mm	20mm	7mm	220g
4401EURDLH (outdoor)	56mm	74mm	27mm	51mm	24mm	9mm	380g



## Stalen hangsloten

Ideaal om deuren en bestelwagens te beveiligen

## Cadenas en acier trempé

Idéal pour sécuriser les portes ou les vans



A2010



A790

Art.Nr.	Body / Corps			Bout / Anse			gewicht poids	pinnen groupilles	sleutels clés	KR*
	breedte largeur	hoogte hauteur	dikte épaisseur	A	B	C				
A2010	72mm	72mm	38mm	15mm	43mm	10mm	980g	6	2	
A790	75mm	65mm	25mm	38mm	34mm	13mm	1040g	6	2	



\*Key retaining

## Massiefstalen hangsloten

## Cadenas en acier massif



A5200



AH100PB



A50

Art.Nr.	Body / Corps			Bout / Anse			gewicht poids	pinnen groupilles	sleutels clés
	breedte largeur	hoogte hauteur	dikte épaisseur	A	B	C			
A5200	44mm	46mm	19mm	30mm	20mm	8mm	300g	5	2
A5200KA	44mm	46mm	19mm	30mm	20mm	8mm	300g	5	2
A50	50mm	46mm	22mm	29mm	20mm	9mm	400g	5	2



### Roestvrijstalen hangsloten

Ideaal voor gebruik in maritieme omgevingen

### Cadenas en acier inoxydable

Idéal pour les environnements marins



A5401



Art.Nr.	Body / Corps			Bout / Anse			gewicht poids	pinnen groupilles	sleutels clés
	breedte largeur	hoogte hauteur	dikte épaisseur	A	B	C			
A5401	44mm	46mm	19mm	54mm	20mm	8mm	280g	5	2
A6400	44mm	46mm	19mm	30mm	20mm	8mm	260g	6	2
A5461	51mm	46mm	19mm	51mm	20mm	9mm	340g	5	2
A6460	51mm	46mm	19mm	29mm	20mm	9mm	320g	6	2

### Messing hangsloten

### Cadenas en laiton



A5570



Art.Nr.	Body / Corps			Bout / Anse			gewicht poids	pinnen groupilles	sleutels clés
	breedte largeur	hoogte hauteur	dikte épaisseur	A	B	C			
A5570	50mm	46mm	19mm	29mm	20mm	9mm	360g	5	2

### Massiefstalen hangsloten

Ideaal voor transport, automaten en industriële toepassingen

### Cadenas en acier massif

Idéal pour le transport, les distributeurs automatiques et applications industrielles



6230



7030



7035



Art.Nr.	Body / Corps			Bout / Anse			gewicht poids	pinnen groupilles	sleutels clés	KR
	breedte largeur	hoogte hauteur	dikte épaisseur	A	B	C				
6230	63mm	55mm	28mm	30mm	23mm	11mm	640g	5	2	
7030	40mm	50mm	20mm	28mm	20mm	6mm	260g	5	2	
7035	40mm	85mm	20mm	28mm	20mm	6mm	340g	5	2	
7040	44mm	50mm	22mm	31mm	23mm	8mm	320g	5	2	
7045	44mm	85mm	22mm	31mm	23mm	8mm	400g	5	2	
7050	48mm	50mm	22mm	39mm	23mm	9mm	360g	5	2	

\*Key retaining

### Gelamineerde stalen hangsloten

Ideaal voor transport, automaten en industriële toepassingen



6321



6121LF

### Cadenas en acier laminé

Ideaal voor het transport, les distributeurs automatiques et applications industrielles



Art.Nr.	Body / Corps			Bout / Anse			gewicht poids	pinnen groupilles	sleutels clés
	breedte largeur	hoogte hauteur	dikte épaisseur	A	B	C			
6321EURD	54mm	81mm	38mm	18mm	22mm	8mm	600g	5	2
6325	61mm	81mm	38mm	18mm	22mm	9mm	700g	5	2
6327EURD	66mm	81mm	39mm	18mm	22mm	11mm	780g	5	2
6121EURD	54mm	60mm	38mm	29mm	23mm	8mm	460g	5	2
6125	60mm	60mm	38mm	35mm	23mm	9mm	520g	5	2
6127EURD	65mm	58mm	38mm	35mm	23mm	11mm	580g	5	2

### Messing hangsloten



6830



Art.Nr.	Body / Corps			Bout / Anse			gewicht poids	pinnen groupilles	sleutels clés
	breedte largeur	hoogte hauteur	dikte épaisseur	A	B	C			
6830	40mm	50mm	20mm	28mm	20mm	6mm	260g	5	2
6840	44mm	50mm	21mm	32mm	23mm	8mm	320g	5	2
6850	48mm	50mm	21mm	39mm	23mm	9mm	360g	5	2

### Cijferhangsloten

Ideaal voor toegang werven



1174

1175

1177

1178



Art.Nr.	Body / Corps			Bout / Anse			gewicht poids	combinaties combinaison
	breedte largeur	hoogte hauteur	dikte épaisseur	A	B	C		
1174D	58mm	50mm	33mm	28mm	25mm	8mm	360g	4
1175D	58mm	50mm	33mm	28mm	24mm	9mm	360g	4
1175DLH	58mm	50mm	33mm	53mm	24mm	9mm	380g	4
1175LHSS	58mm	50mm	33mm	53mm	25mm	8mm	380g	4
1177D	58mm	83mm	33mm	28mm	24mm	9mm	420g	4
1178D	58mm	50mm	34mm	28mm	24mm	9mm	360g	4

### Gelamineerde stalen hangsloten

Ideaal voor winkelvitruines en -afsluitingen

### Cadenas en acier laminé

Idéal pour les grillages et vitrines de commerce



Art.Nr.	Body / Corps			Bout / Anse			gewicht poids	pinnen groupilles	sleutels clés
	breedte largeur	hoogte hauteur	dikte épaisseur	A	B	C			
5EURD	55mm	42mm	31mm	26mm	24mm	9mm	340g	4	2
15EURD	70mm	53mm	37mm	31mm	31mm	11mm	660g	5	2
1	49mm	37mm	29mm	23mm	20mm	8mm	220g	4	2
3EURD	46mm	37mm	27mm	18mm	15mm	7mm	180g	4	2
7	32mm	30mm	18mm	15mm	13mm	5mm	80g	4	2

### Excell hangsloten

Ideaal ter beveiliging van garage, poorten en strenge beveiliging buiten

### Cadenas excell

Idéal pour sécuriser garages, barrières et autres applications haute sécurité en extérieure



Art.Nr.	Body / Corps			Bout / Anse			gewicht poids	pinnen groupilles	sleutels clés	KA
	breedte largeur	hoogte hauteur	dikte épaisseur	A	B	C				
M1EURDLF	48mm	40mm	28mm	28mm	20mm	8mm	320g	4	4	✓
M1EURDLH	48mm	40mm	28mm	51mm	20mm	8mm	320g	4	4	
M1EURDLJ	48mm	40mm	28mm	64mm	20mm	8mm	340g	4	4	✓
M5EURD	52mm	44mm	31mm	25mm	24mm	9mm	420g	4	4	✓
M5EURDLF	52mm	44mm	31mm	38mm	24mm	9mm	420g	4	4	✓
M5EURDLH	52mm	44mm	31mm	51mm	24mm	9mm	440g	4	4	✓
M5EURDLJ	52mm	44mm	31mm	64mm	24mm	9mm	460g	4	4	
M15EURDLF	66mm	50mm	35mm	38mm	31mm	11mm	640g	5	4	✓
M115EURDLF	49mm	47mm	28mm	38mm	20mm	8mm	300g	4	4	✓
M515EURDLH	54mm	50mm	32mm	51mm	24mm	10mm	420g	4	4	
M40EURD	70mm	68mm	29mm	16mm	21mm	10mm	320g	4	4	
M50EURD	80mm	78mm	31mm	17mm	24mm	12mm	440g	4	4	

### Slotsmeerstift

ideaal om gebruik hangsloten te optimaliseren

### Lubrifiant pour systèmes de fermeture

Idéal pour préserver la performance de vos cadenas



Art.Nr.

2300D

### Rechthoekige hangsloten

Ideaal ter beveiliging van opslagplaatsen, afsluitingen fabrieken en winkels



607



690



Art.Nr.	Body / Corps			Bout / Anse			gewicht poids	pinnen groupilles	sleutels clés
	breedte largeur	hoogte hauteur	dikte épaisseur	A	B	C			
607EURD	76mm	50mm	18mm	24mm	14mm	11mm	440g	5	2
608EURD	85mm	55mm	19mm	30mm	15mm	12mm	580g	5	2
690EURD	81mm	68mm	29mm	30mm	15mm	11mm	620g	5	4

### Messing hangsloten

Ideaal ter beveiliging lockers, schuiven en besloten woonwijken



2930



1950



1145



Art.Nr.	Body / Corps			Bout / Anse			gewicht poids	pinnen groupilles	sleutels clés	KA
	breedte largeur	hoogte hauteur	dikte épaisseur	A	B	C				
2930EURD	30mm	33mm	14mm	17mm	16mm	5mm	80g	4	4	
2940EURD	40mm	34mm	16mm	23mm	22mm	6mm	140g	5	4	
2940EURDLH	40mm	34mm	16mm	51mm	22mm	6mm	160g	5	4	
2950EURD	50mm	44mm	17mm	29mm	28mm	8mm	260g	6	4	
2950EURDLJ	50mm	44mm	17mm	64mm	28mm	8mm	280g	6	4	
2960EURD	60mm	43mm	20mm	36mm	33mm	9mm	400g	6	4	
1950EURD	50mm	40mm	17mm	42-121mm	28mm	8mm	320g	5	2	✓
1145EURD	40mm	50mm	20mm	32mm	22mm	7mm	240g	6	4	
1155EURD	50mm	43mm	26mm	29mm	28mm	9mm	400g	6	4	✓

### Hangsloten voor buitengebruik

Ideaal voor gebruik in maritieme omgevingen



2340



550



640



Art.Nr.	Body / Corps			Bout / Anse			gewicht poids	pinnen groupilles	sleutels clés	KA
	breedte largeur	hoogte hauteur	dikte épaisseur	A	B	C				
2340EURDLH	40mm	38mm	16mm	51mm	19mm	7mm	220g	5	2	✓
550EURD	50mm	52mm	23mm	32mm	19mm	9mm	340g	5	2	✓
640EURD	40mm	37mm	13mm	22mm	19mm	6mm	120g	5	2	✓
640EURDLH	40mm	37mm	13mm	52mm	19mm	6mm	140g	5	2	✓

### Cadenas extérieur

Ideaal pour les environnements marins

### Programmeerbare cijferhangsloten

Ideaal voor gebruik op werven en materiaal

### Cadenas à combinaison programmable

Idéal pour les chantiers et les équipements



878



975



175



176



Body / Corps

Bout / Anse

Art.Nr.	breedte largeur	hoogte hauteur	dikte épaisseur	A	B	C	gewicht poids	combinaties combinaison
878DCOM	53mm	47mm	25mm	28mm	25mm	8mm	280g	4
975DCOM	53mm	47mm	25mm	28mm	25mm	8mm	320g	4
975DLHCOM	53mm	47mm	25mm	53mm	25mm	8mm	340g	4
175EURD	52mm	40mm	24mm	26mm	25mm	8mm	220g	4
175EURDLH	52mm	40mm	24mm	58mm	25mm	8mm	280g	4
176	52mm	46mm	24mm	27mm	25mm	8mm	300g	4

### Messing hangsloten

Ideaal ter beveiliging lockers en wandkasten

### Cadenas en laiton

Idéal pour sécuriser casiers ou armoires



4130



120



Body / Corps

Bout / Anse

Art.Nr.	breedte largeur	hoogte hauteur	dikte épaisseur	A	B	C	gewicht poids	pinnen groupilles	sleutels clés	KA
4120	20mm	20mm	10mm	11mm	9mm	3mm	20g	3	2	✓
4130	30mm	26mm	13mm	14mm	14mm	5mm	40g	3	2	✓
4130LJ	30mm	26mm	13mm	64mm	15mm	5mm	60g	3	2	
4140	40mm	33mm	13mm	21mm	20mm	6mm	100g	4	2	✓
4140LH	40mm	33mm	13mm	51mm	20mm	6mm	120g	4	2	
4150	50mm	37mm	14mm	24mm	25mm	7mm	160g	5	2	✓
4160	60mm	46mm	19mm	37mm	34mm	10mm	360g	5	2	✓
4170	70mm	48mm	21mm	45mm	38mm	12mm	580g	5	2	✓
120EURQNOP	20mm	20mm	10mm	11mm	9mm	3mm	30g	3	4	
130EURD	30mm	27mm	12mm	14mm	15mm	5mm	60g	4	2	
130EURDLJ	30mm	27mm	12mm	64mm	15mm	5mm	80g	4	2	
140EURD	40mm	32mm	13mm	21mm	20mm	6mm	100g	4	2	
140EURT	40mm	32mm	13mm	21mm	20mm	6mm	100g	4	2	
140EURQNOP	40mm	32mm	13mm	21mm	20mm	6mm	100g	4	4	
140EURDLH	40mm	32mm	13mm	51mm	20mm	6mm	120g	4	2	
150EURD	50mm	36mm	14mm	24mm	26mm	7mm	180g	5	2	
160EURD	60mm	43mm	15mm	31mm	32mm	8mm	280g	5	2	

### Hangsloten voor buitengebruik

Ideaal voor transport, automaten en industriële toepassingen

### Cadenas extérieur

Ideäl pour le transport, les distributeurs automatiques et applications industrielles



645

Body / Corps



312

Bout / Anse



40



Art.Nr.	breedte largeur	hoogte hauteur	dikte épaisseur	A	B	C	gewicht poids	pinnen groupilles	sleutels clés	KR
645EURD	44mm	32mm	13mm	24mm	24mm	6mm	120g	4	2	
655EURD	50mm	36mm	15mm	25mm	25mm	7mm	180g	5	2	
40EURD	70mm	67mm	28mm	16mm	20mm	9mm	240g	4	2	✓
312EURD	48mm	45mm	32mm	25mm	13mm	10mm	220g	4	2	
312EURDLH	48mm	45mm	32mm	48mm	13mm	10mm	220g	4	2	

### Programmeerbare cijferhangsloten

Ideaal ter beveiliging van lockers en koffers

### Cadenas à combinaison programmable

Ideäl pour sécuriser casiers ou valises



620

Body / Corps



604

Bout / Anse



651



Art.Nr.	breedte largeur	hoogte hauteur	dikte épaisseur	A	B	C	gewicht poids	combinaties combinaison
620EURD	20mm	31mm	9mm	22mm	9mm	3mm	40g	3
630EURD	31mm	36mm	13mm	24mm	14mm	5mm	60g	3
604EURD	40mm	46mm	14mm	24mm	22mm	6mm	220g	4
651EURD	47mm	59mm	13mm	32mm	24mm	9mm	300g	4



7640



4686

7640EURDBLKLH	40mm	46mm	15mm	26mm	21mm	6mm	100g	4
4686EURT	33mm	42mm	14mm	21mm	15mm	3mm	40g	3
1520EURD	64mm	27mm	27mm	34mm	36mm	7mm	180g	4

### Nood hangslot

### Cadenas d'urgence



Art.Nr.	Body / Corps			500 Bout / Anse			gewicht poids	pinnen groupilles	sleutels clés
	breedte largeur	hoogte hauteur	dikte épaisseur	A	B	C			
500KABRK	46mm	31mm	26mm	20mm	21mm	7mm	180g	-	2

### Draagbare hangsloten

### Cadenas portatifs



2650



2076



1500i



1500

Art.Nr.	Body / Corps			Bout / Anse			gewicht poids	pinnen groupilles	sleutels clés	combi- naties combinai- son
	breedte largeur	hoogte hauteur	dikte épaisseur	A	B	C				
2650	60mm	44mm	32mm	23mm	22mm	7mm	200g	4	4	
1500iEURDWHI	55mm	60mm	35mm	27mm	19mm	7mm	140g			
1500iEURDBLK	55mm	60mm	35mm	27mm	19mm	7mm	140g			
1500	48mm	48mm	21mm	22mm	21mm	7mm	120g			
1502	48mm	48mm	21mm	22mm	21mm	7mm	140g			
1525	48mm	48mm	21mm	22mm	21mm	7mm	140g			
2002	55mm	55mm	27mm	28mm	24mm	8mm	300g			
2010	55mm	55mm	27mm	28mm	24mm	8mm	320g			

### Heavy duty grendels

### Morillons haute sécurité



A810



A885



A895

Art.Nr.	lengte longueur	past voor diameter compatible avec diamètre
A885	197mm	11mm
A895	216mm	11mm

## Heavy duty grendels

voor gebruik met hangsloten met verborgen beugel



Art.Nr.	lengte longueur	past voor diameter compatible avec diamètre
A800	230mm	14mm
A801	222mm	14mm
A802	291mm	14mm

## Morillons haute sécurité

pour cadenas à anse cachée

## Hangslotogen



Art.Nr.	lengte longueur	past voor diameter compatible avec diamètre
60	2cm x 5.3cm	13mm
60R	2cm x 5.3cm	13mm

## Œillets pour cadenas

## Scharnierende grendels



Art.Nr.	lengte longueur	past voor diameter compatible avec diamètre
720EURD	16cm	11mm
721EURD	20cm	13mm
722EURD	20cm	11mm
704EURD	11,5cm	13mm
706EURD	15,2cm	14mm

## Morillons à charnière



722

## Heavy duty grendels

## Morillons haute sécurité



730

732

724

Art.Nr.	lengte longueur	past voor diameter compatible avec diamètre
732EURDPF	12cm	11mm
724EURD	19,7cm	12mm

## Heavy duty grendels

voor gebruik met hangsloten met verborgen beugel

## Morillons haute sécurité

pour cadenas à anse cachée



te gebruiken met artikel 6270

736

Art.Nr.	lengte longueur	past voor diameter compatible avec diamètre
770	23cm	11cm
736EURD	23cm	11cm

## Python verstelbare vergrendelingskabel

## Câble de verrouillage réglable Python



8433

Art.Nr.	lengte longueur	past voor diameter compatible avec diamètre	sleutels clés
770	23cm	11cm	4
736EURD	23cm	11cm	4

### Kabel met lussen en kettingen

### Câbles à boucles et chaînes



Art.Nr.	lengte longueur	diameter diamètre	sleutels clés
72EURD	1,80m	10mm	4
78EURD	1,80m	10mm	4
8115EURDPS	1,20m	22mm	4
8010EURD	0,60m	6mm	-
8012EURD	1,50m	6mm	-
8016EURD	1,00m	8mm	-
8017EURD	1,50m	8mm	-
8019EURD	1,00m	10mm	-
8020EURD	1,50m	10mm	-
8028EURD	1,50m	8mm	-

### Sleutelkoffers

### Boîtes à clés



5414



5415



5401



5401\_2

Art.nr.	Buitenzijde / Extérieur			Binnenzijde / Intérieur			
	breedte largeur	hoogte hauteur	diepte profondeur	breedte largeur	hoogte hauteur	diepte profondeur	diameter diamètre
5414EURD	105mm	135mm	46mm	64mm	96mm	35mm	9mm
5415EURD	105mm	135mm	46mm	64mm	96mm	35mm	-
5401EURD	83mm	118mm	34mm	64mm	91mm	28mm	-
5403EURD	105mm	146mm	51mm	79mm	117mm	42mm	-



5400



5412

5400EURD	90mm	101mm	40mm	68mm	78mm	34mm	11mm
5412EURD	95mm	131mm	60mm	68mm	102mm	53mm	-

### Sleutelkasten

### Armoires à clés



7125



KB50-ML



7130

Art.nr.	breedte largeur	hoogte hauteur	diepte profondeur	aantal sleutels capacité de clés
KB-25ML	250mm	188mm	85mm	25
KB-50ML	300mm	239mm	98mm	50
7125D	310mm	270mm	76mm	60
7126D	430mm	330mm	83mm	120

### Anti-diefstal slot voor garagepoort

voor gebruik met hangsloten met verborgen beugel

### Antivol pour porte de garage

Idéal pour protéger une porte de garage basculante de l'extérieur



1488

Art.nr.	sleutels clés
1488EURDAT	2

### Anti-diefstal slot voor aanhangwagens

### Antivol d'attelage universel



377

Art.nr.	past voor trekhaken convient aux têtes d'attelage	sleutels clés
377EURDAT	48-51mm	2

# AFGREDELING

## Manhole barriers

Signalisatiebarrières ter afgrenzing en bescherming van mangaten.  
Voorkomt onbeschermd gebruik of toegang door onbevoegden.  
Bij alle borden zijn de 4 benen, bouten en moeren inbegrepen.



# FERMETURE

## Manhole barriers

Barrières de signalisation pour fermeture et protection des trous homme.  
Empêche l'utilisation sans protection ou accès par des personnes non autorisées.  
Les 4 pattes, les boulons et les écrous sont inclus pour chaque panneau.

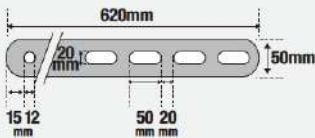

Forex 5mm | Diam. 300mm  
MG012.02

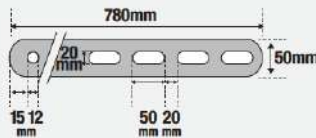

Forex 5mm | Diam. 300mm  
MG013.02

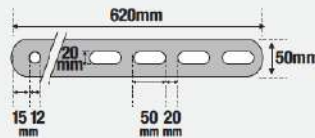

Forex 5mm | Diam. 300mm  
MG012.08

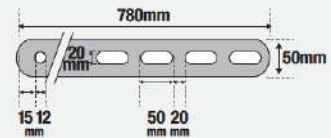

Forex 5mm | Diam. 300mm  
MG013.08

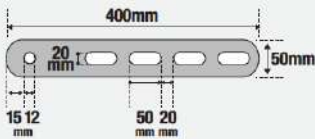

Forex 5mm | Diam. 300mm  
MG014.03

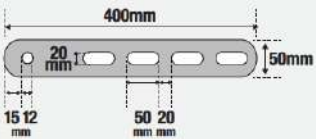

Forex 5mm | Diam. 300mm  
MG014.09

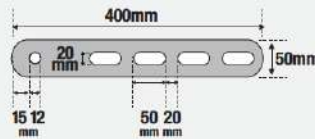

Forex 5mm | Diam. 300mm  
MG014.10

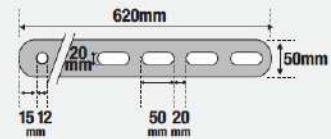

Forex 5mm | Diam. 300mm  
MG012.10

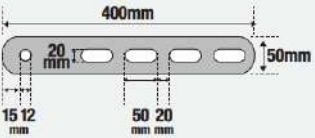

Forex 5mm | Diam. 300mm  
MG114.04

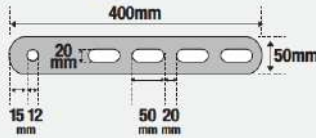

Forex 5mm | Diam. 300mm  
MG114.05

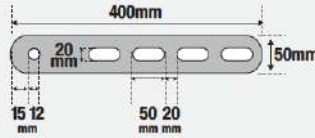

Forex 5mm | Diam. 300mm  
MG114.06

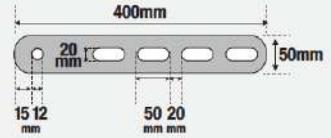

Forex 5mm | Diam. 300mm  
MG114.07

# AFGREDELING

Manhole barriers

# FERMETURE

Manhole barriers

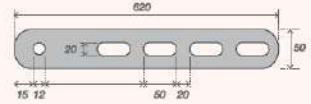
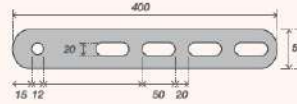
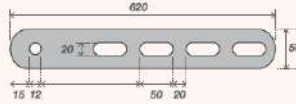
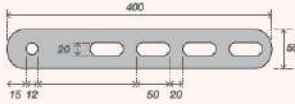

Diam. 300mm	Diam. 300mm	Diam. 300mm	Diam. 300mm
Forex 5mm MG114.11	MG112.11	MG114.12	MG112.12

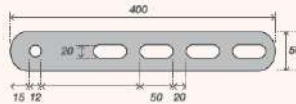
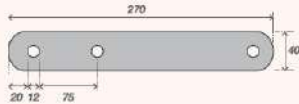

Diam. 300mm	Diam. 300mm
Forex 5mm MG011.01	MG014.13



Vergrendelbare dichte afdekking voor besloten ruimtes met regelbare stalen kabelvergrendeling S806  
 Protection pleine verrouillable pour espaces confinés avec câble en acier réglable S806

- ø510 mm YD501CSS
- ø610 mm YD501CSM
- ø760 mm YD501CSL
- ø915 mm YD501CSXL



Raadpleeg ons gamma sloten  
 Consultez notre gamme de cadenas

## Skirt barriers

## Skirt Barriers

Barrières om snel mangaten, deuropeningen of andere passages af te sluiten.  
Voorkomt onbeschermd gebruik of toegang door onbevoegden.  
Bij alle barrières zijn de bouten en moeren inbegrepen.

Barrières à fermer rapidement les trous homme, les portes ou autres passages.  
Préviend l'utilisation non autorisée ou l'accès non protégé.  
Écrous et boulons inclus pour chaque barrière.



- Gepoedercoat aluminium
- Gegalvaniseerde bouten
- Rode reflecterende tape klasse I
- Afmetingen van 250 tot 2000mm
- Kan op maat geproduceerd worden.
- Aluminium
- Boulons galvanisées
- Tape rouge réfléchissante classe I
- Dimensions de 250 à 2000mm
- Possibilité à produire sur mesure.

250-450mm	SB001
450-640mm	SB002
640-830mm	SB003
830-1120mm	SB004
1410-1700mm	SB005
1700-2000mm	SB006



## Multi barriers

## Multi Barriers

Barrières om snel mangaten, deuropeningen of andere passages af te sluiten.  
Voorkomt onbeschermd gebruik of toegang door onbevoegden.  
Bij alle barrières zijn de bouten en moeren inbegrepen.  
Optioneel mogelijk met een safety koord voor bevestiging bij het plaatsen op hoogte.

Barrières à fermer rapidement les trous homme, les portes ou les autres passages.  
Préviend l'utilisation non autorisée ou l'accès non protégé.  
Écrous et boulons inclus pour chaque barrière.  
Corde de sécurité optionnelle pour fixation en hauteur.



- Gepoedercoat aluminium
- Gegalvaniseerde bouten
- Rode reflecterende tape klasse I
- Afmetingen van 250 tot 2000mm
- Kan op maat geproduceerd worden.
- Borden op aanvraag
- Aluminium
- Boulons galvanisées
- Tape rouge réfléchissante classe I
- Dimensions de 250 à 2000mm
- Possibilité à produire sur mesure.
- Panneaux sur demande

250-450mm	CSB001
450-640mm	CSB002
640-830mm	CSB003
830-1120mm	CSB004
1410-1700mm	CSB005
1700-2000mm	CSB006

Safety leash
CSB00A



**A**

Aan- afwezig bord	195
Aanwijzingsborden	130-140
Achterzijdemarkering	304
<b>ADR-etiketten</b>	<b>296-297</b>
AED ILCOR	35
AED ISO 7010	22
Afbakening	213-225
Afbakeningslinten	283
Afbakeningsnetten	252
Afbakeningsrondjes	240
Afgrendeling	381-383
Afrolbaar lint	210-214
Afsluiting	252-254
Afstandsbevestigingen	181-183
Alarmsystemen	76
Alu-lock	166-167
<b>Antislip</b>	<b>279-282</b>
Armbanden	294
Asbeststickers	311

**B**

Badges	187-188
<b>Bakens</b>	<b>255</b>
Barcodes	268
Barreel	252
Begeleiding	148-157
Beschermingsbarrières	249-251
Besloten ruimten	128-129
Betonvoeten	231
<b>Beugels</b>	<b>232</b>
<b>Bevestigingen</b>	<b>179-186</b>
Bewakingspiegels	286
Bigfoot	231
Blanco materialen	146
Blanco labels	366-367
Blusdeken	73
Blusser picto	52
Blusser picto ISO 7010	44
Bordhouders	335-336
Braille	190
Brandalarm	73
<b>Brandbestrijding</b>	<b>52-60</b>
Brandbestrijding ISO 7010	44-50
Brandbestrijdingsmiddelen	73
Brandblusserdrager	73
Brandwondenverzorging	114
Breeklicht	75
Brochurehouders	208-209
<b>Buismarkeringen</b>	<b>318-335</b>
Bumcare	114

**C**

<b>Camerabewaking</b>	<b>144</b>
Cijfers & letters	265-266
Cijfersloten	374-376
<b>Clicframes</b>	<b>204-205</b>
CLP	313-317
Combinatieborden	128-129
Confined space covers	382
Curvo	190

**D**

<b>Datumborden</b>	<b>230</b>
Defibrillator	22
Deuren-pictogrammen	158-165
Digital signage	5
Dispensers	315
Doekframe	197-198
Draaistel	74
Driehoekssleutel	222
Driepoot	217
Dubbelzijdige tape	179

**E**

Educatie	148-157
Eerste hulp	113
Eerste hulp bij elektrocutie	125
EHBO	17
Eigendomsetiketten	66
Eigen tekst	178
Elektrische spanning	116
<b>Etage aanduiding</b>	<b>36</b>
Etikettdispensers	315
Evacuatieplannen	67
Exit control	43

**F**

Fluit	76
<b>Fotolum tapes</b>	<b>37</b>

**G**

<b>Gebodstekens</b>	<b>106-110</b>
Gebodstekens ISO 7010	102-105
Gefreesde pictogrammen	141-143
Gegraveerde plaatjes	66
Gerecycleerde paal	222
<b>Gevaarstekens</b>	<b>120-124</b>
Gevaarstekens ISO 7010	116-119
<b>GHS</b>	<b>313-317</b>
Groot formaat	158-165

**H**

Handafdrukken	37
<b>Harmonicahekken</b>	<b>253</b>
Haspel picto	53
Haspel picto ISO 7010	45
<b>Hekken</b>	<b>253</b>
Helmsstickers	36
Hesjes	294
Hoekbescherming	247
<b>Hydrant</b>	<b>61</b>

**I**

<b>Imo</b>	<b>78-87</b>
Industriële bescherming	247-251
Industriële markering	66
Industriële spiegels	285
<b>Infopalen</b>	<b>214-215</b>
Infoplaatjes	166-167
Inspectiespiegels	287
Instaekhoezen	267
Interventielampen	308
Interventiesignalisatie	115

**K**

<b>Kabelbescherming</b>	<b>241-242</b>
Kabelbinders	272
Kantelmast	74
Kazuivel	294
Kegeladapter	214
<b>Kegels</b>	<b>309-310</b>
Keilbout	186
<b>Ketting</b>	<b>220</b>
Ketting metaal	180
Keuringsstickers	64-65
Kinderpictogrammen	148-157
Klikkader	204-205
Koffers	293
Kolombescherming	246
Koorden	216
Krijt	262
Krijtstift	230
Kurkborden	208

**L**

<b>Lampen</b>	<b>288-292</b>
Lanyard	187
Leidingmarkeringen	318-335
<b>Linten</b>	<b>283</b>
Locatieaanduiding	61-62
<b>Lock-out stations</b>	<b>345-346</b>
L-profiel	246
Luxepictogrammen	189-194

**M**

Machinerichtlijnen	125-127
<b>Magazijnsignalisatie</b>	<b>265-269</b>
Magneetborden	206-207
Magneetlabels	270-271
Manhole barriers	381-382
Markeringen	257-262
Markeringsbanden	276
Mast	74
<b>Masterlock</b>	<b>337-380</b>
Materialen	2
Mededelingsborden	206-208
Megafoon	76
Merkplaatjes	66
Metalen palen	217
Minitoot	231
Mini picto	67-72
Moduleerbare palen	219
<b>Module plus indoor</b>	<b>194-195</b>
Module plus outdoor	196
MS-Polymeren	179
.MT	178
Muurhaspel	213
Muurlinten	212-213
Muuruitkraging	232

**N**

<b>Netten</b>	<b>252</b>
Noodhamer	73
Noodsleutelkastje	73
Noodverlichting	39-42
Nummerplaten	310

**O**

Obstructiepaal	246
Ondergronds waarschuwinglint	283
Ongevallenborden	6
Oogspoel	113
Ophangpictogrammen	168-171
Opvouwbare kegels	310
Opvouwbare signalisatie	254
Opvulbare hekken	253
Outdoor signage	197-198
<b>Overlastborden</b>	<b>307</b>



Antislip

## P

Paal met lint	210-212
Paaldop	231
<b>Palen</b>	<b>231</b>
Palletmarkeringen	269
Parat	222
<b>Parkeerbeugels</b>	<b>226</b>
Parkeerverbod sets	230
Parkingsignalisatie	226-230
Peli	288-293
Perforatietang	64
Permaroute	277-278
Permastripe	277-278
Pijlborden	234
Plaatsingen	4
Plank PVC	221
Plato plus	191
Pleisters	113
Plexihouder	193
Plombex	275
<b>Posterframes</b>	<b>203</b>
Posters	3
PVC palen	218
Pyxis	192

## R

Rails	232
Reclame	197-198
Recyclage	145
<b>Redding &amp; evacuatie</b>	<b>24-36</b>
Redding & evacuatie ISO 7010	12-23
Reddingsboei	76
Reddingsmiddelen	76
Reddingsvest	76
Reflectoren	309
<b>Retroreflecterende tapes</b>	<b>276</b>
Richtlijnen bij brand	63
Roken verboden	93
Roken verboden ISO 7010	90
Roll-up banner	198
Roekmelder	73
Routemarkering	37

## S

Safety Sign Services	4
SB250	233-234
Scheepvaart	88-89
Schoolbusbord	303
<b>Seals</b>	<b>272-275</b>
Secubox	111-112
Secupoint	112
Seingeverbord	294
Separatoren	254
Sesam	222
S-haakje	181
Signaalhoorn	76
<b>Sjablonen</b>	<b>263-264</b>
Skirt barriers	383
Sleutelbeheerkasten	355
Sleutelkastje	73
Sloten	337-380
Slotvermeerdereaars	343-344
Snaphlight	75
Soppec	257-262
Spanningen	232
Spiegelbeeld	147
<b>Spiegels</b>	<b>284-287</b>
Spuitbussen	257-261
Spuitmallen	263-264
Staalkabel	184
Stoepbord	205
<b>Stootbanden</b>	<b>243-245</b>
Stoethoeken	245
Stootkap	252
Stootkussen	240

## T

Taghouders	208-209
<b>Tags</b>	<b>357-367</b>
<b>Tapes</b>	<b>276-282</b>
Teksten	172-177
Telescopische barrières	221
Toegangshellingen	240
Toilet	131-132
Totems	197
Traff-O-Sign	295-310
Transfert	158-165
<b>Transportetiketten</b>	<b>295-297</b>
Trapsignalisatie	37
<b>Transway</b>	<b>210-212</b>
Triopan	254
Type 250	233-234
Type 2000	233-234

## U

<b>Uitzonderlijk vervoer</b>	<b>306-307</b>
U-profiel	246

## V

Veiligheidshangsloten	338-342
Veiligheidsregister	73
Veiligheidsreling	247-248
<b>Veiligheidszegels</b>	<b>272-275</b>
<b>Verbodstekens</b>	<b>93-101</b>
Verbodstekens ISO 7010	90-92
Verdieping nummering	36
Verf	257-261
Vergrendeling nooduitgang	43
<b>Verkeersborden</b>	<b>233-237</b>
Verkeersdrempels	239-240
Verkeershulp	239-240
Verkeersspiegels	284
<b>Verpakking</b>	<b>310-312</b>
Verpakkingstape	311
<b>Vervaldagaanduiding</b>	<b>64-65</b>
<b>Verzamelplaats</b>	<b>23</b>
Verzegeldraad	275
Verzegelingen	272-275
Vital-ID	114
<b>Vitrines</b>	<b>199-203</b>
Vloermarkering	276
Vloerstickers	77
Vlucht ladder	73
<b>Vluchtwegsignalisatie</b>	<b>24-29</b>
Vluchtwegsignalisatie ISO 7010	12-16
Voertuigmarkering	304-305
Voetafdrukken	37
Voeten	231
Vogels op transfert	147
Vrij- bezet bord	195

## W

<b>Waarschuwing</b>	<b>120-124</b>
Waarschuwing ISO 7010	116-119
Waarschuwingstags	357-364
WC	131-132
<b>Wegsignalisatie</b>	<b>233-237</b>
Werborden	256
Werfmarkeringen	257
Werknemeridentificatie	114
Where to go	193
Windsnelheid	74
<b>Windzak</b>	<b>74</b>
Winkelspiegels	287
Wissellijst	204-205

## X

X-Last palen	223-225
--------------	---------

## Y

<b>Zebraborden</b>	<b>254</b>
Zuilen	197
Zwaailichten	308



Stootbanden

243-245



Spiegels

284-287

## A

<b>ADR-étiquettes</b>	296-297
Aides circulation	239-240
Affichage numérique	5
Alarme incendie	73
Alu-look	166-167
Amiante étiquettes	311
<b>Amortisseurs de choc</b>	243-245
<b>Antidérapants</b>	279-282
Anti-feu	73
<b>Avertissement signaux</b>	120-124
Avertissement signaux ISO 7010	116-119
Avertisseur	76

## B

Badges	187-188
<b>Balises</b>	<b>255</b>
Bandes de marquages	276
Banners roll-up	198
Barrière avec planches	252
<b>Barrières à lester</b>	<b>253</b>
<b>Barrières de parking</b>	<b>226</b>
Barrières de protection	249-251
Barrières harmonica	253
Barrières télescopiques	221
Bâtons lumineux	75
Bigfoot	231
Blanco	146
Boîte à clés	73
Boîte registre	73
Boîtes de condamnation	355
Bouée de sauvetage	76
Boyau d'incendie picto	53
Boyau d'incendie picto ISO 7010	45
Braille	190
Brassards	294
<b>Brides</b>	<b>232</b>
Burncare	114

## C

Cable acier	184
Cadenas	337-380
Cadres clic	204-205
Calotte	231
<b>Caméra surveillance</b>	<b>144</b>
Capuchons	252
Casque étiquettes	36
Chaîne métallique	180
<b>Chaînes</b>	<b>220</b>
Chasubles	294
Chiffres & lettres	265-266
Clé triangulaire	222
<b>Clicframes</b>	<b>204-205</b>
<b>Clôtures de chantier</b>	<b>252</b>
CLP	313-317
Codes barres	268
Coffres	293
Coins amortisseurs	245
Colliers	232
Colonnes	197
<b>Cônes</b>	<b>309-310</b>
Confined space covers	382
Cordons	216
Coussin butoir	240
Couverture anti-feu	73
Craies	262
Crochet-S	181
Crochets multi-points	343-344
Curvo	190

## D

<b>Danger signaux</b>	<b>120-124</b>
Danger signaux ISO 7010	116-119
DAE ILCOR	35
DEA ISO 7010	22
Débrillateur	22
Délimitation	213-225
Dériveurs muraux	213
Détecteur de fumée	73
Directives en cas d'incendie	63
Directives machines	125-127
Distributeurs étiquettes	315
Douille expansible	186

## E

Echelle d'évacuation	73
Eclairage de secours	39-42
Education	148-157
<b>Emballage</b>	<b>311-312</b>
Emplacement technique	61-62
Empreintes mains	37
Empreintes pieds	37
Équipement sauvetage	76
Espaces confinés	128-129
<b>Etage numérotation</b>	<b>36</b>
Étiquettes blanco	366-367
Étiquettes de prévention	357-364
<b>Étiquettes transport</b>	<b>295-297</b>
<b>Evacuation &amp; sauvetage</b>	<b>24-36</b>
Evacuation & sauvetage ISO 7010	12-23
Exit control	43
Extincteur picto	52
Extincteur picto ISO 7010	44

## F

Fermeture	381-383
Feux-gyrophares	308-309
Fil périé	275
<b>Fixations</b>	<b>179-186</b>
Fixations espacement	181-183
Frames	197-198
Fumer interdiction	93
Fumer interdiction ISO 7010	90

## G

Gilet de sauvetage	76
Gilets	294
Girouettes	74
Grand format	158-165
Gravures	66
Guidance	148-157

## H

<b>Hydrant</b>	<b>61</b>
----------------	-----------

Identification employé	114
Image réfléchie	147
<b>Imo</b>	<b>78-87</b>
Indication signaux	130-140
Information plaquettes	166-167
Installations	4
<b>Interdiction signaux</b>	<b>93-101</b>
Interdiction signaux ISO 7010	90-92
Interdit de stationner sets	230
Intervention signalisation	115

Labels magnétiques	<b>270-271</b>
<b>Lampes</b>	288-292
Lampes d'intervention	308
Lanyard	187
Libre-occupé panneau	195
Luxe	189-194

## M

<b>Magasin signalisation</b>	265-269
Magnétique labels	270-271
<b>Manche à air</b>	<b>74</b>
Manhole barriers	381-382
Maritime	88-89
Marquage arrière	304
Marquage de route	37
<b>Marquage de tuyauteries</b>	<b>318-335</b>
Marquage industrielle	66
Marquage pour voitures	304-305
Marquages	257-262
Marquages palettes	269
Marquage sol	77 et 276
Marqueur de craie	230
Marteau de secours	73
<b>Masterlock</b>	<b>337-380</b>
Mat	74
Matériaux	2
Matériaux anti-feu	73
Mégaphone	76
Minifoot	231
Mini picto	67-72
<b>Miroirs</b>	<b>284-287</b>
<b>Module plus indoor</b>	<b>194-195</b>
Module plus outdoor	196
MS-Polymères	179
MT - Votre propre texte	178

## O

<b>Obligation signaux</b>	<b>106-110</b>
Obligation signaux ISO 7010	102-105
Oiseaux sur transfert	147
Outdoor signage	197-198



Miroirs

284-287

## P

Panneau bus scolaire	303
Panneau signaleur	294
<b>Panneaux à date</b>	<b>230</b>
Panneaux chantiers	256
<b>Panneaux charges exécutaires</b>	<b>307</b>
Panneaux combinés	128-129
Panneaux d'accidents	6
Panneaux en flèche	234
<b>Panneaux routières</b>	<b>233-237</b>
<b>Panneaux zèbres</b>	<b>254</b>
Pansements	113
Parat	222
Parking	226-230
<b>Pastilles calendrier</b>	<b>64-65</b>
Peinture	257-261
Peli	288-293
Permaroute	277-278
Permastripe	277-278
<b>Photolum rubans adhésifs</b>	<b>37</b>
Pictogrammes à crochet	168-171
Pictogrammes découpés	141-143
Pictogrammes luxe	189-194
Pieds	231
Pieds en béton	231
Pince à perforer	64
Planche PVC	221
Plans d'évacuation	67
Plaques d'immatriculation	226
Plaques marquages	66
Plaquettes d'information	166-167
Plato plus	191
Plombex	275
Plots de chaussée	240
Pochettes	267
<b>Pochoirs</b>	<b>263-264</b>
<b>Point de rassemblement</b>	<b>23</b>
Polymères	179
Porte affiche plexi	193
Porte badge	187-188
Porte brochure & tags	208-209
Porte-extincteur	73
Portes pictogrammes	158-165
Posterframes	203
Posters	3
Poteau à sangle	210-212
Poteau obstruction	246
Poteau recyclé	222
<b>Poteaux</b>	<b>231</b>
<b>Poteaux info</b>	<b>214-215</b>
Poteaux métalliques	217
Poteaux modulaires	219
Poteaux PVC	218
Premiers secours	17
Premiers soins	113
Premiers soins en cas d'électrocution	125
Présent-absent panneau	195
Profile-L	246
Profile-U	246
Propre texte	178
Propriété étiquettes	66
<b>Protection cables</b>	<b>241-242</b>
Protection coin	247
Protection colonne	246
<b>Protection incendie</b>	<b>52-60</b>
Protection incendie ISO 7010	44-50
Protection industrielle	247-251
Publicité	197-198
Pyxis	192

## R

Rails	232
Ralentisseurs	239-240
Rampe de sécurité	247-248
Rampes d'accès	240
Récyclage	145
Réfecteurs	309
Rince-œil	113
Route d'évasion	24-29
Route d'évasion ISO 7010	12-16
<b>Rubans</b>	<b>283</b>

## S

Safety Sign Services	4
Sangles déroulables	210-214
Sangles murales	212-213
<b>Scellés de sécurité</b>	<b>272-275</b>
<b>Seals</b>	<b>272-275</b>
Secubox	111-112
Secupoint	112
Séparateurs	254
Serre-câble	272
Sesam	222
<b>SGH</b>	<b>313-317</b>
Sifflet	76
Signalisation d'intervention	115
Signalisation escalier	37
Signalisation magasin	265-269
Signalisation parking	226-230
Signalisation pliable	254
<b>Signalisation routière</b>	<b>233-237</b>
Signaux de danger	120-124
Signaux de danger ISO 7010	116-119
Signaux d'indication	130-140
Signaux d'interdiction	93-101
Signaux d'interdiction ISO 7010	90-92
Signaux d'obligation	106-110
Signaux d'obligation ISO 7010	102-105
Skirt barriers	383
Snaplight	75
Soin brûlures	114
Soppec	257-262
<b>Stations Lock-out</b>	<b>345-346</b>
Stop-trottoir	205
Support panneaux	335-336
Surveillance par caméra	144

Tableaux d'affichage	206-208
Tableaux magnétique	206-207
<b>Tags</b>	<b>357-367</b>
Tape double face	179
<b>Tapes</b>	<b>276-282</b>
Tapes d'emballage	311
<b>Tapes rétro réfléchissants</b>	<b>276</b>
Tension électrique	116
Textes	172-177
Toiles	197-198
Toilettes	131-132
Totems	197
Traceurs de chantier	257
Traff-O-Sign	295-310
Transfert	158-165
<b>Transport exceptionnel</b>	<b>306-307</b>
<b>Transway</b>	<b>210-212</b>
Trépied	217
Triangles pliables	254-255
Triopan	254
Tuyauteries marquage	318-335
Type 250	233-234
Type 2000	233-234

## V

Verrouillage	252-254
Verrouillage issues de secours	43
Vital-ID	114
<b>Vitrines</b>	<b>199-203</b>
Where to go	193
X-Last	223-225

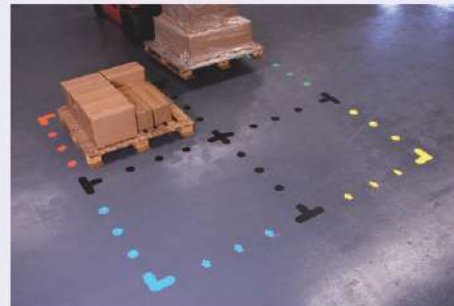

Permaroute 277-278



Transway 210-212



Ralentisseurs 239-240



## COVID-19 Algemene maatregelen

Meer informatie vind je op: [www.info-coronavirus.be](http://www.info-coronavirus.be)  
[www.rivm.nl/coronavirus-covid-19](http://www.rivm.nl/coronavirus-covid-19)



	PP	Vinyl
210x297mm	3823.C01	3833.C01
297x420mm	3824.C01	3834.C01



	PP	Vinyl
297x210mm	3823.C07	3833.C07
420x297mm	3824.C07	3834.C07



	PP	Vinyl
210x297mm	3823.C02	3833.C02
297x420mm	3824.C02	3834.C02



	PP	Vinyl
297x210mm	3823.C08	3833.C08
420x297mm	3824.C08	3834.C08



	PP	Vinyl
210x297mm	3823.C03	3833.C03
297x420mm	3824.C03	3834.C03



	PP	Vinyl
297x210mm	3823.C09	3833.C09
420x297mm	3824.C09	3834.C09

COVID-19 Mésures générales

Pour plus d'informations, voir : [www.info-coronavirus.be](http://www.info-coronavirus.be)



	PP	Vinyl
210x297mm	3823.C04	3833.C04
297x420mm	3824.C04	3834.C04



	PP	Vinyl
297x210mm	3823.C10	3833.C10
420x297mm	3824.C10	3834.C10



	PP	Vinyl
297x210mm	3823.C05	3833.C05
420x297mm	3824.C05	3834.C05



	PP	Vinyl
297x210mm	3823.C11	3833.C11
420x297mm	3824.C11	3834.C11



	PP	Vinyl
297x210mm	3823.C06	3833.C06
420x297mm	3824.C06	3834.C06



	PP	Vinyl
297x210mm	3823.C12	3833.C12
420x297mm	3824.C12	3834.C12



## Instructies handhygiëne

## Instructions hygiène des mains



	PP	Vinyl	PP	Vinyl
210x297mm	3823.30	3833.30	3823.31	3833.31
297x420mm	3824.30	3834.30	3824.31	3834.31

## Gebodstekens

## Signaux d'obligation

Zie pagina 102 - 110 voor meer pictogrammen en uitvoeringen

Voir pages 102 - 110 pour plus de pictogrammes et versions



	Vinyl	PP	Vinyl	PP	Vinyl	PP	Vinyl	PP	Vinyl	PP	Vinyl	PP	Vinyl	PP
90mm	3431.MH	3421.MH	3431.SD1	3421.SD1	3431.SD2	3421.SD2	3431.11	3421.11	3431.B4	3421.B4	3431.J4	3421.J4	3431.J8	3421.J8
200mm	3432.MH	3422.MH	3432.SD1	3422.SD1	3432.SD2	3422.SD2	3432.11	3422.11	3432.B4	3422.B4	3432.J4	3422.J4	3432.J8	3422.J8



	Vinyl	PP	Vinyl	PP	Vinyl	PP	Vinyl	PP	Vinyl	PP	Vinyl	PP	Vinyl	PP
90mm	3431.B5	3421.B5	3431.F0	3421.F0	3431.O5	3421.O5	3431.89	3421.89	3431.AT	3421.AT	3431.AV	3421.AV	3431.AU	3421.AU
200mm	3432.B5	3422.B5	3432.F0	3422.F0	3432.O5	3422.O5	3432.89	3422.89	3432.AT	3422.AT	3432.AV	3422.AV	3432.AU	3422.AU



	Vinyl	PP	Vinyl	PP	Vinyl	PP	Vinyl	PP	Vinyl	PP	Vinyl	PP
90mm	3431.AX	3421.AX	3431.AW	3421.AW	3431.AS	3421.AS	3431.AK	3421.AK	3431.95	3421.95	3431.94	3421.94
200mm	3432.AX	3422.AX	3432.AW	3422.AW	3432.AS	3422.AS	3432.AK	3422.AK	3432.95	3422.95	3432.94	3422.94

## Verbodstekens

## Signaux d'interdiction

Zie pagina 90 - 101 voor meer pictogrammen en uitvoeringen

Voir pages 90 - 101 pour plus de pictogrammes et versions



	Vinyl	PP	Vinyl	PP	Vinyl	PP	Vinyl	PP	Vinyl	PP	Vinyl	PP
90mm	3231.GN	3221.GN	3231.HS	3221.HS	3231.HN	3221.HN	3231.J7	3221.J7	3231.O3	3221.O3	3231.AL	3221.AL
200mm	3232.GN	3222.GN	3232.HS	3222.HS	3232.HN	3222.HN	3232.J7	3222.J7	3232.O3	3222.O3	3232.AL	3222.AL

**Gevaarstekens**

**Signaux de danger**

Zie pagina 116 - 123 voor meer pictogrammen en uitvoeringen

Voir pages 116 - 123 pour plus de pictogrammes et versions



	Vinyl	PP	Vinyl	PP
90mm	3531.24	3521.24	3531.02	3521.02
200mm	3532.24	3522.24	3532.02	3522.02

**Vloermarkeringen**

**Marquages au sol**



	Multigrip Vinyl + Laminaat	Multigrip Vinyle + Laminat
1000x100mm	61F2.01	61F2.02



	Multigrip Vinyl + Laminaat	Multigrip Vinyle + Laminat
1000x100mm	61F2.03	61F2.04



	Multigrip Vinyl + Laminaat	Multigrip Vinyle + Laminat
1000x100mm	61F2.05	61F2.06



	Multigrip Vinyl + Laminaat / Multigrip Vinyle + Laminat	Multigrip Vinyl + Laminaat / Multigrip Vinyle + Laminat
1000x100mm	61F2.07	61F2.MT

Zie pagina 257 - 264 voor meer sjablonen en spuitbussen

Voir pages 257 - 264 pour plus de pochoirs et bombes de peinture

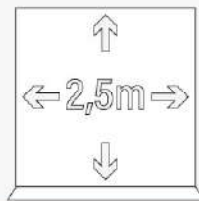
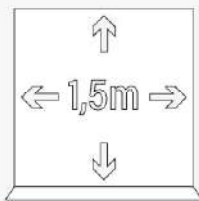

	Dibond 2mm	Dibond 2mm
250x250mm	5817.SD1	5817.SD2
500x500mm	5819.SD1	5819.SD2



niet inbegrepen  
non-incluse





## Vloermarkeringen

Multigrip Vinyl + Laminaat

## Marquages au sol

Multigrip Vinyle + Laminat



300mm 61F3.01 61F3.02 61F3.03 61F3.04 61F3.05 61F3.06 61F3.07



300mm 61F3.3203 61F3.B1 61F3.B5 61F3.B19 61F3.B21 61F3.C1 61F3.C19



300mm 61F3.D1 61F3.D1E 61F3.D1F 61F3.D3A 61F3.D3B 61F3.SD1 61F3.SD2

## Tapes & Linten

Meer informatie vindt u op pagina 276 en 283

## Bandes adhésives & rubans

Vous trouvez plus d'informations à la page 276 et 283

⚠ 1,5 METER AFSTAND HOUDEN AUB ⚠ 1,5 METER AFSTAND HOUDEN AU

⚠ RESPECTEZ LA DISTANCE DE 1,5M ⚠ RESPECTEZ LA DISTANCE DE 1,5M

75mmx300m

K8023

K8024



## Plexi preventieschermen

## Hygiaphones en plexi



475x805x275mm SCREEN1

- Sterke stand door de gebogen vorm
- Eenvoudige montage zonder gereedschap
- Werknemers en klanten beschermen tegen druppels
- Gemaakt van hogewaardige kwaliteit PMMA



805x605x275mm SCREEN2



1005x805x275mm SCREEN3

- Une position forte par sa forme incurvée
  - Montage simple sans outils
- Protéger les employés et clients contre les gouttelettes
  - Fabriqué en PMMA de haute qualité

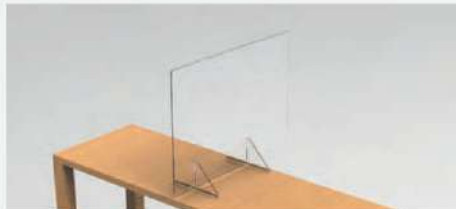

600x418x200mm SCREEN4

- Voorzien van een boring in iedere hoek
- Ideaal om aan het plafond op te hangen

Bevestigingsmateriaal vindt u terug in onze catalogus vanaf pagina 180.  
Andere modellen mogelijk op aanvraag



800x600x200mm SCREEN5

- Prévu d'un forage dans chaque coin.
- Idéale pour suspendre au plafond.

Fixations à trouver dans notre catalogue à partir de la page 180.  
Autres modèles possible sur demande

## Gelaatsscherm

## Écran facial



APET gelaatsscherm  
Écran facial APET SCREEN6

## Roll up preventiescherm

## Roll up écran de protection



Transparant scherm  
Lichtgewicht systeem  
Voorzien van klemprofiel boven  
2 stabiele draaivoeten  
Stabilisator aan achterzijde  
Per stuk verpakt in stevige, gevoerde draagtas en karton

Écran transparent  
Système léger  
Profil de serrage en haut  
2 pieds stables pivotants  
Stabilisateur sur l'arrière  
Emballé par pièce en sac rembourré robuste et carton

1000x2000mm BANNER1





## Hygiënische deuropeners

## Ouvre-portes hygiénique



HANDLE01

Hygiënische deuropener 3D zwart, cirkel, recht, breed, voor deurklinken met ronde handgrepen ø 51-54 mm

Ouvre-porte hygiénique 3D noir, cercle, droit, large, pour poignées de porte avec poignées rondes ø 51-54 mm



HANDLE02

Hygiënische deuropener 3D zwart, cirkel, recht, smal, voor deurklinken met ronde handgrepen ø 47-50 mm

Ouvre-porte hygiénique 3D noir, cercle, droit, étroit, pour poignées de porte avec poignées rondes ø 47-50 mm



HANDLE03

Hygiënische deuropener 3D zwart, cilindrisch, breed, voor niet-gebogen handgrepen ø 16-22 mm

Ouvre-porte hygiénique 3D noir, cylindrique, large, pour poignées de porte droites ø 16-22 mm



HANDLE04

Hygiënische deuropener 3D zwart, cilindrisch, smal, voor gebogen en niet-gebogen handgrepen ø 16-22 mm

Ouvre-porte hygiénique 3D noir, cylindrique, étroit, pour poignées de porte courbée/non courbée ø 16-22 mm



HANDLE05

Hygiënische deuropener 3D zwart, smal, voor rechthoekige, horizontale handgrepen hoogte 11-20 mm en diepte max. 25 mm

Ouvre-porte hygiénique 3D noir, étroit, pour poignées rectangulaires et horizontales hauteur 11-20 mm et profondeur max. 25 mm



HANDLE06

Hygiënische deuropener 3D zwart, smal, voor rechthoekige, verticale handgrepen hoogte 31 mm en diepte 4-11 mm

Ouvre-porte hygiénique 3D noir, étroit, pour poignées rectangulaires, verticales hauteur 31 mm et profondeur 4-11 mm



HANDLE07

Hygiënische deuropener 3D zwart, breed, voor rechthoekige, horizontale handgrepen hoogte 11-20 mm en diepte max. 25 mm

Ouvre-porte hygiénique 3D noir, large, pour poignées rectangulaires et horizontales hauteur 11-20 mm et profondeur max. 25 mm



HANDLE08

Hygiënische deuropener 3D zwart, breed, voor rechthoekige, verticale handgrepen hoogte 31 mm en diepte 4-11 mm

Ouvre-porte hygiénique 3D noir, large, pour poignées rectangulaires et verticales hauteur 31 mm et profondeur 4-11 mm



Vinyl	
100x50mm	1730.P9
200x100mm	1731.P9

## Plooibare bakens

Meer informatie vindt u op pagina 255



## Balises pliables

Vous trouvez plus d'informations à la page 255



## Afbakening

Meer informatie vindt u op pagina 210 en 221



## Délimitation

Vous trouvez plus d'informations à la page 210 et 221





## Luchtzuiveraar

De SanificaAria is een toestel dat continu de lucht ontsmet door middel van een UV-C lamp, geplaatst in een optisch gesloten container.

De werking berust op het principe dat UV-C straling alle levende organismes zoals virussen en bacteriën doodt, inclusief de Covid-19 virussen.

Het toestel is uitgerust met een detectiesensor. Deze sensor voorkomt dat de lamp werkt en er UV-C straling vrijkomt als er mensen of dieren in de ruimte aanwezig zijn.

Met de afstandsbediening kan u de sterilisatiecyclus instellen tussen 15,' 30' of 1u.



### Specificaties / Spécifications

Voedingseenheid met 2m kabel	120-277V
Bloc d'alimentation avec cable 2m	
Verbruik / Consommation	25 W
UV-C golflengte / Longueur d'onde UV-C	254nm
Zuiveringsgraad / Degré d'épuration	
UV-C vermogen / Capacité UV-C	18 W
UV-C stralingsvermogen / Émissivité UV-C	5,5 W
Verwachte levensduur van de patroon* /	12 maanden
Esperance de vie de la cartouche*	12 mois

SanificaAria 30	B26700
Patroon / Cartouche	B26720

\* Levensduur berekend voor gemiddeld dagelijks gebruik van 24u

\* Durée de vie calculé pour utilisation quotidienne moyenne de 24h



## Purificateur d'air

Le SanificaAria est un appareil qui désinfecte l'air en permanence par une lampe UV-C, qui se trouve dans un récipient esthétique scellé.

Son fonctionnement est basé sur le principe que le rayonnement UV-C tue tous les organismes vivants tels que les virus et les bactéries, y compris les virus Covid-19.

L'appareil est équipé d'un capteur de détection. Ce capteur empêche la lampe de fonctionner et le rayonnement UV-C lorsque des personnes ou des animaux sont présents dans la pièce.

Avec la télécommande, vous pouvez régler le cycle de stérilisation entre 15,' 30' ou 1h.



### Specificaties / Spécifications

Voedingseenheid met 2m lange kabel	120-277V
Bloc d'alimentation avec cable 2m	
Minimaal opgenomen vermogen /	36 W
Puissance absorbée minimale	
Maximaal opgenomen vermogen /	60 W
Puissance absorbée maximale	
UV-C golflengte / Longueur d'onde UV-C	254nm
Zuiveringsgraad / Degré d'épuration	
UV-C vermogen / Capacité UV-C	24 W
UV-C stralingsvermogen / Émissivité UV-C	7,5 W
Aanbevolen levensduur van de patroon* /	12 maanden
Esperance de vie da la cartouche*	12 mois

SanificaAria 200	B26702
Patroon / Cartouche	B26721



SMART-Q2

SMART-Q2



Crowd management systeem met automatische detectie om het aantal bezoekers bij te houden dat zich tegelijkertijd in het gebouw bevindt.  
 Batterijvoeding (tot 11 uur onafgebroken werking) of netvoeding.

Système de gestion des foule avec détection automatique pour compter le nombre de visiteurs qui se trouvent dans le bâtiment au même moment.  
 Alimentation par batterie (jusqu'à 11 heures de fonctionnement) ou bloc d'alimentation.

Smart Q2 Crowdcontrol B94753

Luchtkwaliteitsmonitor CO2

Moniteur qualité de l'air CO2



WL1020

Afmetingen / Dimensions: 82x82x25mm  
 AC-/USB- adapter/adaptateur incl.  
 2 x AAA Micro LR03 excl.  
 Meetbereik temperatuur / Étendue de mesure température -9.9°C - 50°C  
 Meetbereik vochtigheid / Étendue de mesure humidité 10% - 95%

WL1020



WL1030

Afmetingen / Dimensions: 94x145x50mm  
 Voedingsadapter / Adaptateur alimentation incl.  
 Meetbereik temperatuur / Étendue de mesure température 0°C - 50°C  
 Meetbereik vochtigheid / Étendue de mesure humidité 20% - 95%

WL1030



VOOR BESTELLINGEN & SERVICE, UW VERDELER:  
POUR COMMANDES & SERVICE, VOTRE DISTRIBUTEUR:

A large white rectangular area, likely a placeholder for a name or contact information, located below the text.